



# 1507850

---

## User's Manual

Edition: 1.0

2009/10/30



## **Copyright**

Copyright 2009 all rights reserved. This document is copyrighted and all rights are reserved. The information in this document is subject to change without prior notice to make improvements to the products. This document contains proprietary information and protected by copyright. No part of this document may be reproduced, copied, or translated in any form or any means without prior written permission of the manufacturer. All trademarks and/or registered trademarks contains in this document are property of their respective owners.

## **Disclaimer**

The company shall not be liable for any incidental or consequential damages resulting from the performance or use of this product. The company does not issue a warranty of any kind, express or implied, including without limitation implied warranties of merchantability or fitness for a particular purpose. The company has the right to revise the manual or include changes in the specifications of the product described within it at any time without notice and without obligation to notify any person of such revision or changes.

## **Trademark**

All trademarks are the property of their respective holders.

---

## Packing List:

### Hardware :

1507850 PCI Express mini Card x1

### Cable Kit:



Dual DB9 Cable X 2

### CD Content :

Drivers & User's Manual

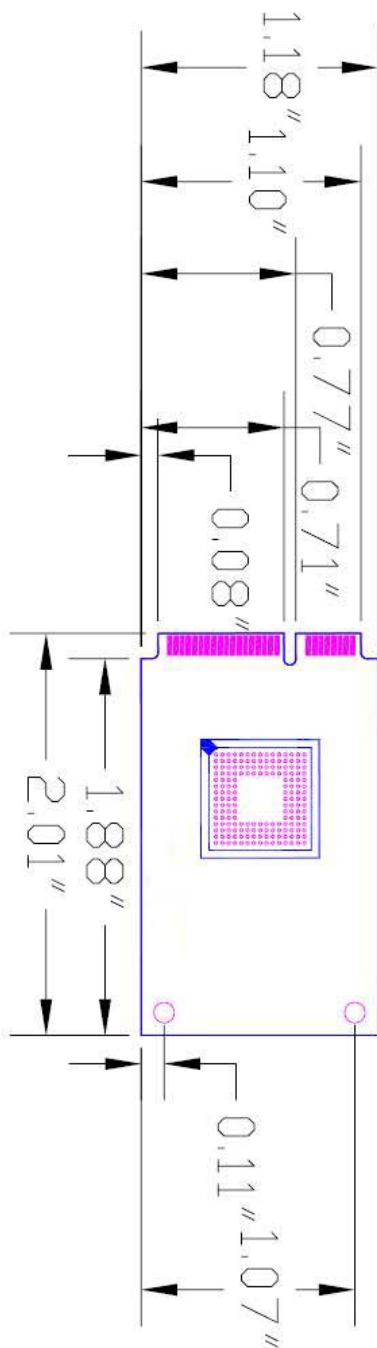

(This Page is left for Blank)

# Chapter 1 <Introduction>

## 1.1 <General Specification>

### General Specification

Form Factor	PCI Express mini card
Controller	OXFORD OXPCIe954
Features	Four 16C950 High performance UART channels

## 1.2 <Connector Assignment>

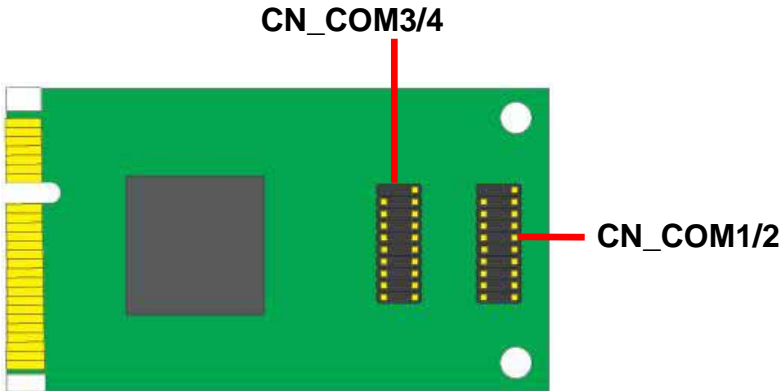

## 1.21 <COM Port>

**Connector: CN\_COM1/2**

**Type: 20-pin (10x2 pitch=1.27x2.54mm) header**

Pin	Description	Pin	Description
1	DCD1-	2	RX1-
3	TX1-	4	DTR1-
5	GND	6	DSR1-
7	RTS1-	8	CTS1-
9	RI1	10	NC
11	DCD2-	12	RX2-
13	TX2-	14	DTR2-
15	GND	16	DSR2-
17	RTS2-	18	CTS2-
19	RI2	20	NC

**Connector: CN\_COM3/4**

**Type: 20-pin (10x2 pitch=1.27x2.54mm) header**

Pin	Description	Pin	Description
1	DCD3-	2	RX3-
3	TX3-	4	DTR3-
5	GND	6	DSR3-
7	RTS3-	8	CTS3-
9	RI3	10	NC
11	DCD4-	12	RX4-
13	TX4-	14	DTR4-
15	GND	16	DSR4-
17	RTS4-	18	CTS4-
19	RI4	20	NC

### 1.3 <Driver Setting>

1. Copy the CD Driver folder to disk, Ex: C:\ , D:\ ...
2. Please choose “**Device Manager**”

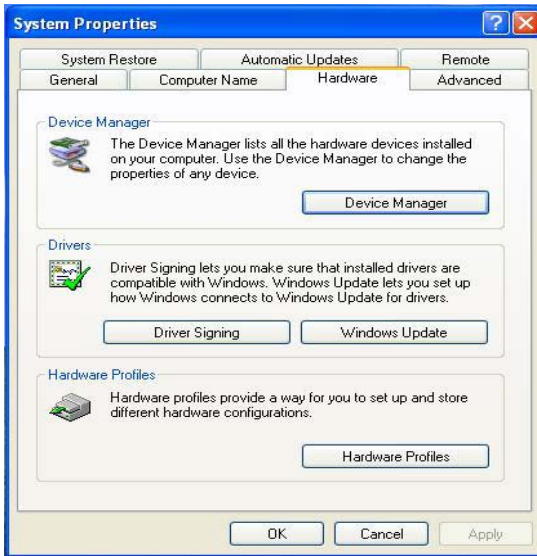

3. You can see other devices ”**PCI Serial Port**”

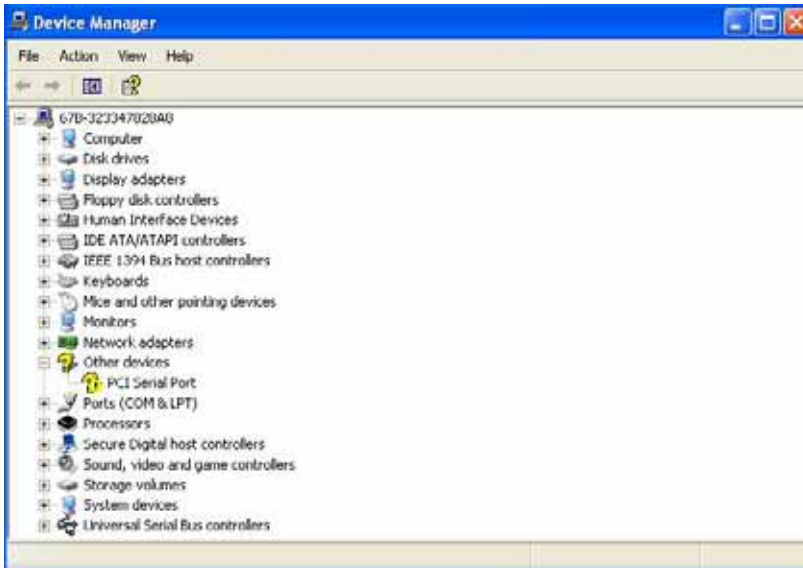



#### 4. Please choose **“Other PCI Bridge Device”** then press **Update Driver**

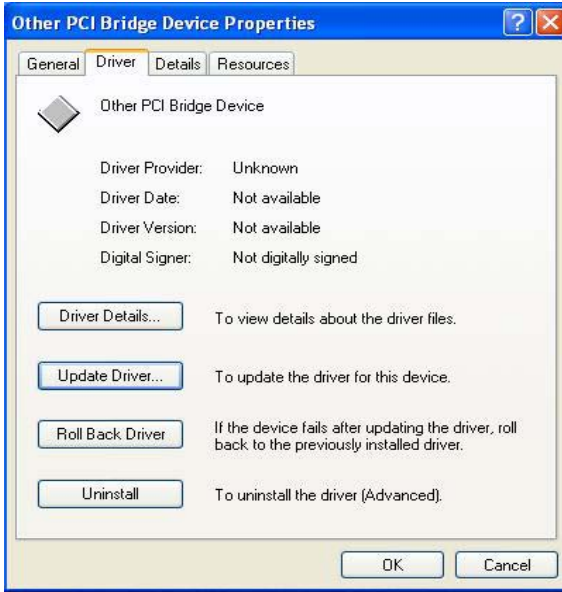

#### 5. Please choose **”NO, not this time“**



**6. Install software for "PCI Serial Port" Please choose "Install from a list or specific location"**

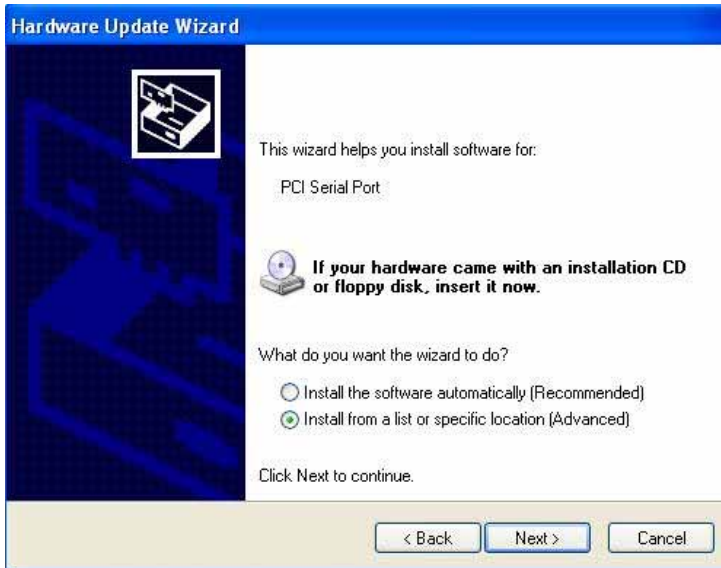

**7. Please choose "Search for the best driver in these location"  
Check "Include this location in the search"**

## 9. Completing the hardware update wizard



## 10. Install finish

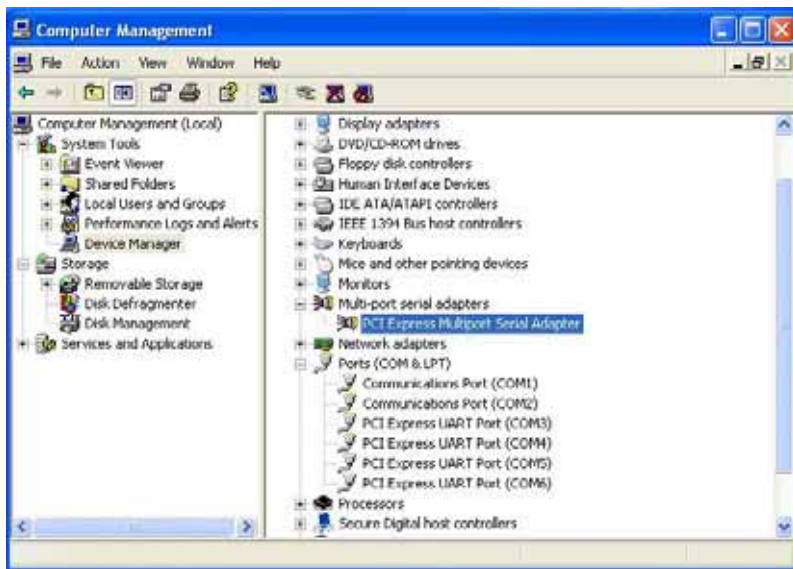

Any advice or comments about our products and service, or anything we can help you with please don't hesitate to contact with us. We will do our best to support you for your products, projects and business.

## **Global American Inc.**

Address: 17 Hampshire Drive  
Hudson, NH 03051

TEL: Toll Free (U.S. Only) 800-833-8999  
(603)886-3900

FAX: (603)886-4545

Website: <http://www.globalamericaninc.com>

E-Mail: [salesinfo@globalamericaninc.com](mailto:salesinfo@globalamericaninc.com)

