

---

# 2801114

## **User's Manual Edition 1.0**

### **Copyright**

Copyright© 2002, 2003. All rights reserved. This document is copyrighted and all rights are reserved. The information in this document is subject to change without prior notice to make improvements to the products.

This document contains proprietary information and protected by copyright. No part of this document may be reproduced, copied, or translated in any form or any means without prior written permission of the manufacturer.

All trademarks and/or registered trademarks contains in this document are property of their respective owners.

### **Disclaimer**

Global American Inc. shall not be liable for any incidental or consequential damages resulting from the performance or use of this product.

Global American Inc. does not issue a warranty of any kind, express or implied, including without limitation implied warranties of merchantability or fitness for a particular purpose.

The company has the right to revise the manual or include changes in the specifications of the product described within it at any time without notice and without obligation to notify any person of such revision or changes.

### **Trademark**

All trademarks are the property of their respective holders.

---

# Packing List

---

## 2801114 :

### Hardware

2801114 Motherboard..... X 1

### Cable Kit

40-pin ATA100 IDE Flat Cable..... X 1

34-pin Floppy Cable..... X 1

Dual-USB Port Cable..... X 1

DB9 COM Port Cable..... X 1

Audio Cable..... X 1

I/O Shield..... X 1

### Printed Matter and Software

User's Manual..... X 1

Driver CD..... X 1

---

# Table of Content

<b>CHAPTER 1. INTRODUCTION.....</b>	<b>5</b>
1.1    PRODUCT OVERVIEW .....	5
1.2    SPECIFICATION .....	6
1.3    COMPONENT PLACEMENT .....	9
1.4    BLOCK DIAGRAM.....	10
<b>CHAPTER 2. HARDWARE SETUP .....</b>	<b>11</b>
2.1    CONNECTOR LOCATION .....	11
2.2    CPU AND DRAM SETTING .....	14
2.3    CMOS SETTING.....	15
2.4    WATCHDOG TIMER SETTING .....	16
2.5    EMBEDDED SOLID STATE DISK .....	17
2.6    POWER AND FAN CONNECTOR.....	18
2.7    VGA INTERFACE .....	19
2.8    ETHERNET INTERFACE .....	22
2.9    AUDIO INTERFACE .....	23
2.10   SWITCH AND INDICATOR .....	25
<b>CHAPTER 3. BIOS SETUP.....</b>	<b>27</b>
<b>CHAPTER 4 AUDIO CHANNEL CONFIGURATION .....</b>	<b>29</b>

---

<b>APPENDIX A</b>	<b>I/O PORT PIN ASSIGNMENT .....</b>	<b>31</b>
<b>APPENDIX B.</b>	<b>FLASH THE BIOS .....</b>	<b>37</b>
B.1	BIOS AUTO FLASH TOOL .....	37
B.2	FLASH METHOD.....	37
<b>APPENDIX C.</b>	<b>SYSTEM RESOURCES .....</b>	<b>39</b>
<b>CONTACT INFORMATION.....</b>		<b>44</b>

---

# Chapter 1. Introduction

## 1.1 Product Overview

**2801114** is an all-in-one industrial compact Pentium 4 level motherboard based on Mini-ITX form factor at 170 x 170 mm of dimension. Based on Intel 845GV and ICH4 chipset, **2801114** offers the compact, embedded, value and high performance solution with Intel Pentium 4 CPU, 533 / 400 MHz of FSB, 1GBytes DDR200/266/333 SDRAM, Intel 845GV GMCH built-in Intel Extreme Graphics, Intel PRO/100+ LAN, Hi-Speed USB 2.0, IEEE 1394, 5.1 channel and S/P DIF 3D audio, TV-out and embedded flash disk interfaces.

### **Compact Mini-ITX Form Factor @ 170 x 170 mm**

**2801114** is based on the ultra compact mini-ITX form factor at only 170 x 170 mm of dimension, meets the demand of compact and powerful computing platform. With this feature, **2801114** should be the ideal solution for the high-end, Pentium 4 level book-size, slim type and other embedded PC systems.

### **Powerful Pentium 4 Computing Platform**

With Intel Socket 478 Pentium 4 / Celeron CPU at 533/400 MHz FSB and 1GBytes DDR200/266/333 SDRAM of system memory, **2801114** offers the high-end industrial computing platform with low cost Intel integrated solutions.

### **Value / High Performance Multi-media Solution**

The Intel 845GV GMCH chipset built-in Intel Extreme Graphics, 6 channel and S/P DIF AC97 3D audio make **2801114** be the high performance but low cost multi-media AV platform. With this feature,

**2801114** should be the ideal solution for VoD (Video on Demand), DVR (Digital Video Recorder), digital video broadcasting (DVB), streaming, surveillance, compression (MPEG), interaction server, POS, Kiosk, ATM, Panel PC, transaction workstation and terminal applications.

### **Hi-Speed USB 2.0 and IEEE 1394 Interface**

Intel ICH4 built-in Hi-Speed USB 2.0 controller and onboard IEEE 1394 chipset let **2801114** offer up to 480 Mbps of Hi-Speed USB 2.0 and 100/200/400 Mbps of IEEE 1394 interfaces.

---

## 1.2 Specification

General Specification	
Form Factor	Mini-ITX at 170 x 170 mm (L x W)
CPU	Intel Socket 479 Pentium® 4 Processor - M @ 400 MHz FSB(no support battery mode)
Memory	1GBytes DDR200/266/333 SDRAM on one 184-pin DIMM socket
Chipset	Intel 82845GV GMCH and 82801DB ICH4
BIOS	Phoenix-Award 2Mb PnP flash BIOS
Green Function	Power saving mode includes doze, standby and suspend modes. ACPI version 1.0 and APM version 1.2 compliant
Watchdog Timer	System reset programmable watchdog timer with 1 ~ 255 sec./min. of timeout value
Real Time Clock	Intel ICH4 built-in RTC with lithium battery
Enhanced IDE	PCI enhanced IDE interface supports dual channels and up to 4 ATAPI devices at UltraATA/100 One 40-pin and one 44-pin IDE port DiskOnModule (DOM) embedded flash disk up to 1GBytes
Expansive Slot	One PCI slot supports up to 2 bus master PCI bus interface via the additional riser card

Multi-I/O Port	
Chipset	Intel 82801DB ICH4 (USB) and Winbond W83627HF-AW LPC Super I/O controller
Serial Port	One internal RS-232 serial port with 16C550 compatible UART and 16 bytes FIFO
USB Port	Four Hi-Speed USB 2.0 ports with 480 Mbps of data transfer rate Two external and two internal USB ports
Parallel Port	One external bi-direction parallel port with SPP/ECP/EPP mode
Floppy Port	One FDD port supports up to two FDD
IrDA Port	One IrDA compliant Infrared interface supports CIR/SIR
K/B & Mouse	External PS/2 keyboard and mouse ports on rear I/O panel

---

**VGA Display Interface**

Chipset	Intel 845GV GMCH built-in Intel Extreme Graphics With 266 MHz VGA core and 256-bit 3D engine
Memory	Intel dynamic video memory up to 64 Mbytes shared with system
Display Type	CRT, LCD monitor and analog display Up to 4 textures / pixel on a single pass and 2048x2048 texture size
Connector	External DB15 female connector on rear I/O panel Internal 40-pin LVDS connector

**TV-out Interface**

Chipset	Intel 845GV GMCH built-in Intel Extreme Graphics with Chrontel CH7017A-T TV-out encoder
TV Mode	Support both of NTSC and PAL mode
Connector	External S-video and RCA Jack on rear I/O panel

**Ethernet Interface**

Chipset	Intel PRO/100+ LAN interface with Intel ICH4 and 82562ET PHY
Type	10Base-T / 100Base-TX, auto-switching Fast Ethernet Full duplex, IEEE802.3U compliant
Connector	External RJ45 connector with LED on rear I/O panel

**Audio Interface**

Chipset	Intel ICH4 with Realtek ALC650 AC97 3D audio codec
Interface	5.1 channel 3D audio with front (R/L), rear (R/L), center and bass S/P DIF digital audio encoding signal input and output Line-in, line-out, CD-in and MIC-in
Connector	External three phone jack for 5.1 channel audio on rear panel External S/P DIF connector on rear panel Internal 10-pin header for line-in/-out, MIC-out, 4-pin header for CD-in

---

**IEEE1394 Interface**

Chipset	Agere FW323 PCI IEEE1394 controller
Interface	IEEE1394 with 100/200/400 Mbps of data transfer bandwidth
Connector	External IEEE1394 connector on rear I/O panel

**Power and Environment**

Power Requirement	20-pin ATX power connector Additional +12V on 4-pin connector for Pentium 4 PSU
Dimension	170 (L) x 170 (H) mm, Mini-ITX form factor
Temperature	Operating within 0 ~ 60°C (32 ~ 140°F) Storage within -20 ~ 85°C (-4 ~ 185°F)
EMI	

**Ordering Code**

<b>2801114-GAI</b>	Mini-ITX Socket 479 Pentium 4 processor –M Motherboard with Intel Extreme VGA, LAN, TV-out, 5.1-CH/SPDIF Audio, Hi-Speed USB 2.0, IEEE1394 Interface and LVDS interface.
--------------------	--

---



---

## 1.3 Component Placement

ALC650 AC97 Audio Codec  
With 5.1 Channel Audio  
S/P DIF, Line-in/out, Mic-in  
and CD-in Interface

### Chipset on Back Side

- Intel 82562ET LAN Phy
- Agere FW323 IEEE1394 Controller

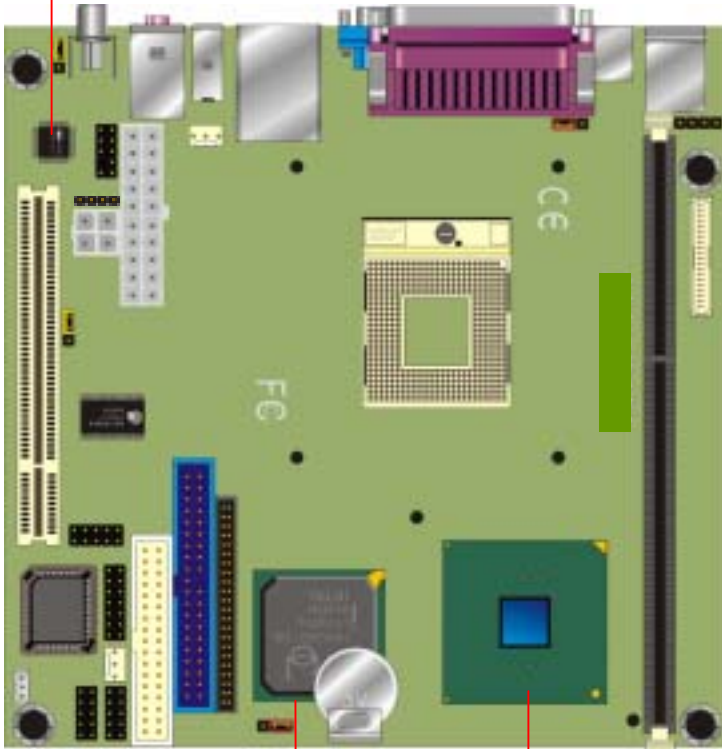

Intel 82801DB ICH4  
With Hi-Speed USB 2.0  
UltraATA100 IDE  
Intel PRO/100+ LAN Mac

Intel 845GV GMCH  
With 533 / 400 MHz Host Bus  
200 / 266 / 333 MHz Memory Bus  
Intel Extreme Graphics

# 1.4 Block Diagram

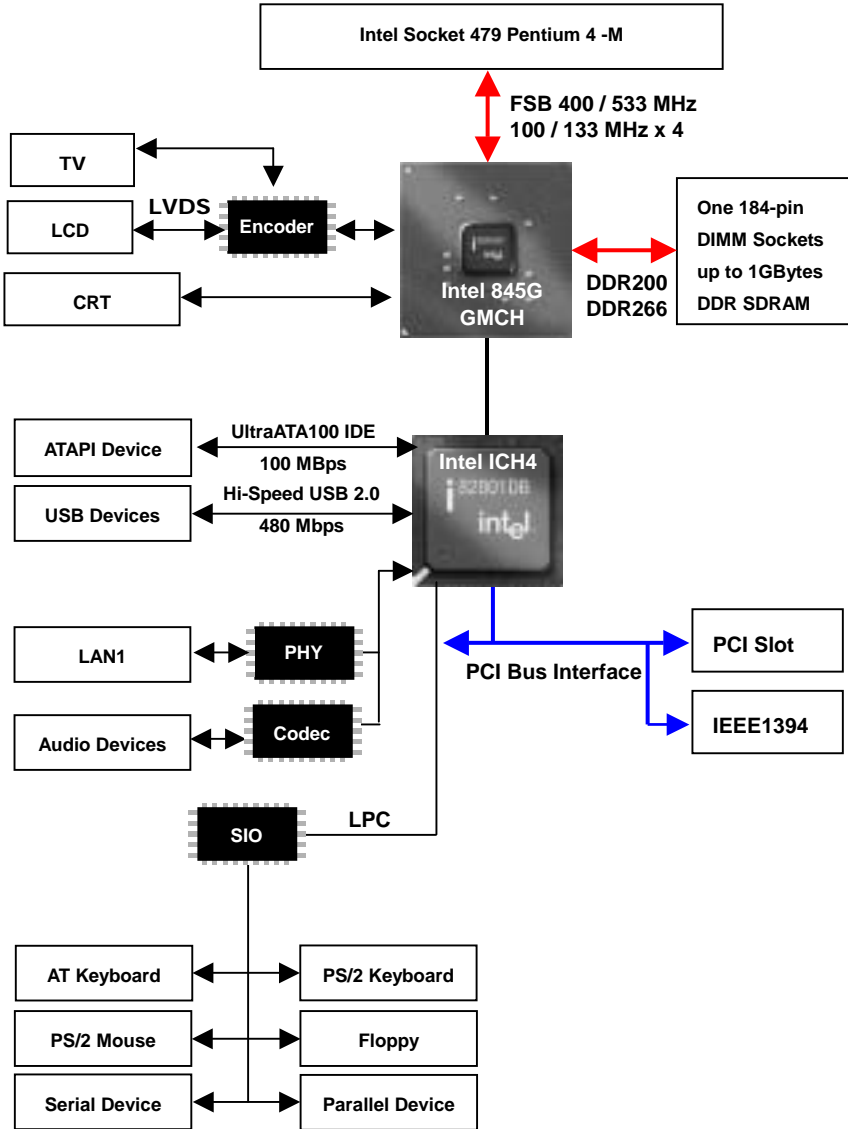

# Chapter 2. Hardware Setup

This chapter contains the information for installation of hardware. The install procedure includes jumper settings, CPU and memory installation, fan, I/O and panel connections.

## 2.1 Connector Location

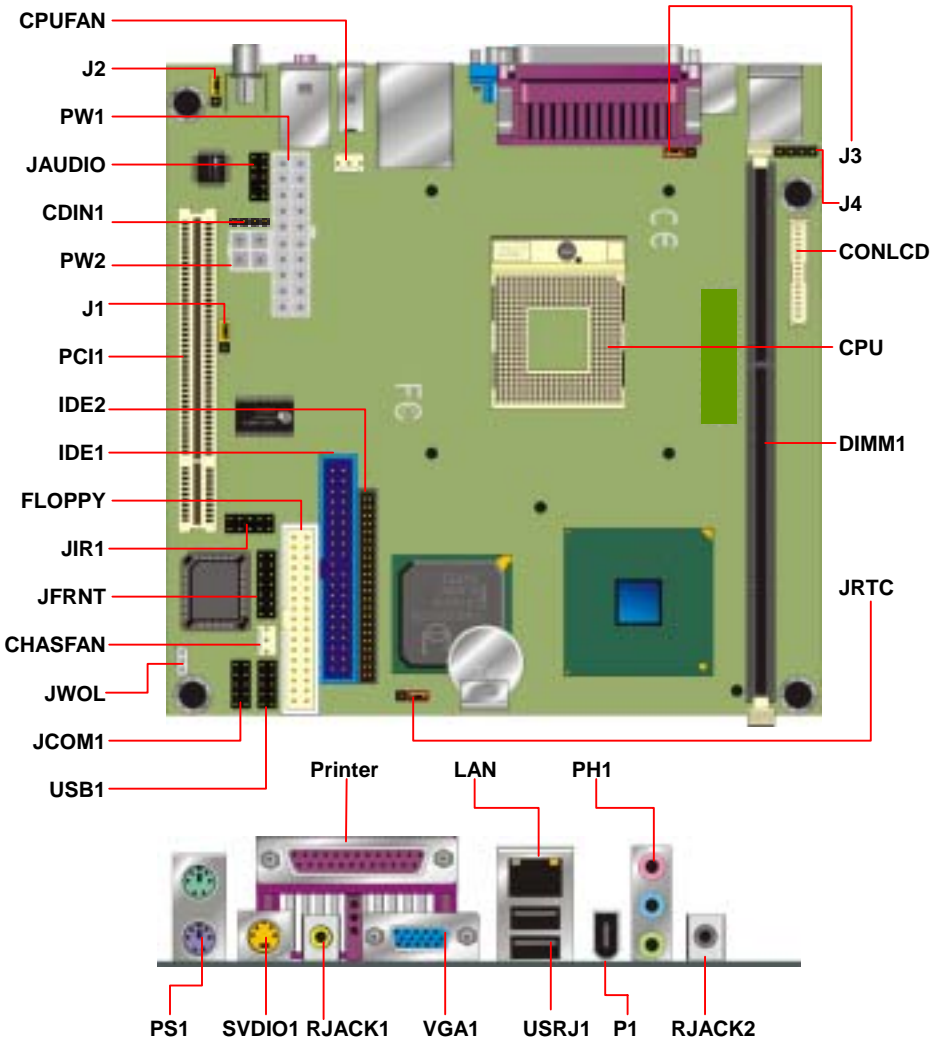

---

## 2.1.1 Jumper Reference

### 2801114

Jumper	Function
JRTC	COMS Operate / Clear Setting
J1	IEEE1394 Enable/Disable Setting
J2	S/P DIF Input / Output Setting
J3	Panel Voltage Setting

### Jumper Setting Quick Reference

Jumper	1-2	2-3
JRTC	Clean CMOS	Normal Operation
JKBV	KB with +5V	KB with +5VSB
J1	IEEE1394 Enable	IEEE1394 Disable
J2	S/P DIF Output	S/P DIF Input
J3	+5V	+3.3V

Default setting

---

## 2.1.2 Connector Reference

<b>Internal Onboard Connector</b>		
<b>Connector</b>	<b>Function</b>	<b>Remark</b>
CPU	MicroPGA479 CPU Socket	Standard
DIMM1	184-pin DIMM Socket	Standard
IDE1	40-pin Primary IDE Port	Standard
IDE2	44-pin Secondary IDE Port	Standard
FDC1	34-pin FDD Port	Standard
JCOM1	10-pin COM1 RS-232 Serial Port	Standard
USB1	10-pin 3rd / 4th Hi-Speed USB 2.0 Port	Standard
JIR1	10-pin CIR / SIR IrDA Port	Standard
PW1	20-pin ATX Power Connector	Standard
PW2	4-pin Additional +12V Power Connector	Standard
JFRNT	14-pin Switch and Indicator Connector	Standard
CPUFAN	3-pin +12V CPU Fan Connector	Standard
CHASFAN	3-pin +12V System Fan Connector	Standard
JAUDIO	10-pin Audio Port	Standard
CDIN	4-pin CD-in Interface	Standard
WOL1	3-pin Wake-On-LAN Interface	Standard
CONLCD	40-pin LVDS connector	Standard
J4	5-pin LCD Inverter Power Connector	Standard

<b>External Connector on Bracket</b>		
<b>Connector</b>	<b>Function</b>	<b>Remark</b>
PS1	PS2 Keyboard / Mouse 6-pin Connector	Standard
Printer	Parallel Port DB25 Female Connector	Standard
SVDIO1	S-Video TV-out Connector	Standard
RJACK1	AV TV-out RCA Jack	Standard
VGA1	VGA DB15 Female Connector	Standard
LAN	LAN RJ45 Connector with LED	Standard
USRJ1	Dual USB Connector	Standard
P1	IEEE1394 Connector	Standard
PH1	Audio RCA Connector	Standard
RJACK2	S/P DIF Digital Audio Connector	Standard

---

## 2.2 CPU and DRAM Setting

The board is based on Intel Socket 479 architecture with Intel 845G chipset, supports Intel Socket 479 Pentium 4 Processor –M at 400 MHz FSB.

System memory of this board supports up to 1GBytes DDR200/266/333 SDRAM on two 184-pin DIMM sockets. Please notices that Intel 845G GMCH **DOESN'T** support ECC and register DIMM.

### 2.2.1 Processor Installation Notice

To install the Intel Pentium 4 Mobile Processor properly, Please follow the steps blow.

1. Unlock the processor socket.
2. Install the processor onto the socket well.
3. Lock the processor socket.

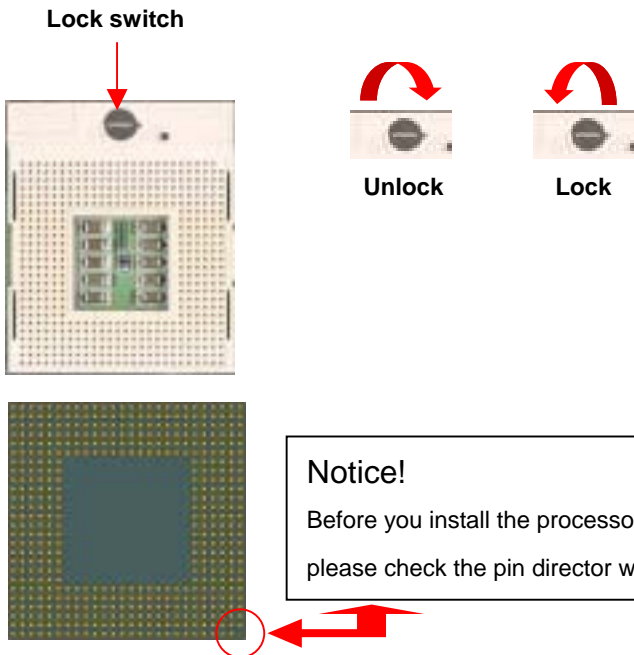

---

## 2.3 CMOS Setting

The board's data of CMOS can be setting in BIOS. If the board refuses to boot due to inappropriate CMOS settings, here is how to proceed to clear (reset) the CMOS to its default values.

Jumper: **JRTC**

Type: onboard 3-pin header

JRTC	Mode
1-2	Clear CMOS
2-3	Normal Operation

Default setting

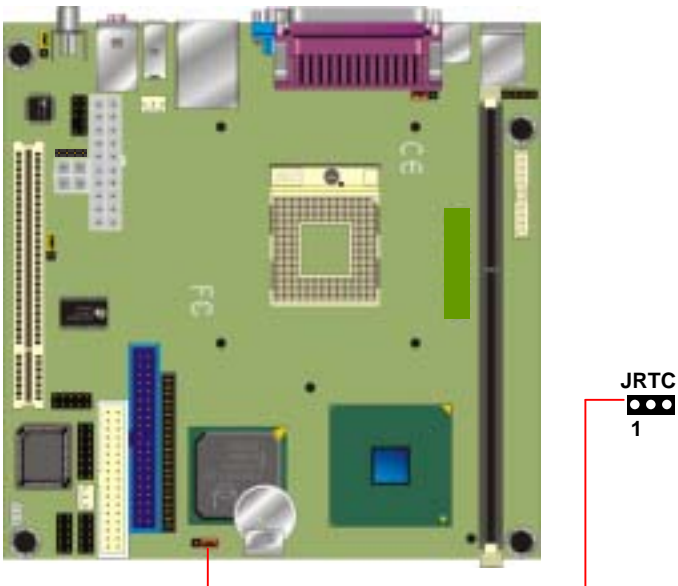

---

## 2.4 Watchdog Timer Setting

The watchdog timer makes the system auto-reset while it stop to work for a period. The integrated watchdog timer can be setup as system reset mode by program.

### Timeout Value Range

- 1 to 255
- Second or Minute

### Program Sample

Watchdog timer setup as system reset with 5 second of timeout

---

2E, 87	
2E, 87	
2E, 07	
2F, 08	Logical Device 8
2E, 30	Activate
2F, 01	
2E, F5	Set as Second*
2F, 00	
2E, F6	Set as 5
2F, 05	

---

\* Minute: bit 3 = 0; Second: bit 3 = 1



---

## 2.5 Embedded Solid State Disk

The **2801114** supports the IDE-based, bootable and driver free DiskOnModule (DOM) embedded flash disk. The onboard 40-pin IDE1 and 44-pin IDE2 box header supports normal DOM (DiskOnModule) or M-systems DiskOnChip IDE Pro flash disk with or without the additional Vcc power cable.

## 2.6 Power and Fan Connector

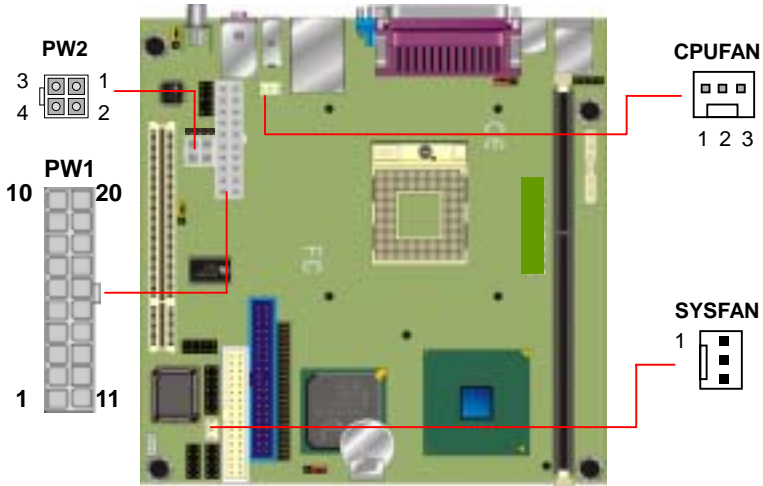

Connector: **PW2**

Type: 4-pin standard Pentium 4 additional +12V power connector

Pin	Description	Pin	Description
1	Ground	2	Ground
3	+12V	4	+12V

Connector: **PW1**

Type: 20-pin ATX power connector

PIN assignment			
1	3.3V	11	3.3V
2	3.3V	12	-12V
3	GND	13	GND
4	5V	14	PS_ON
5	GND	15	GND
6	5V	16	GND
7	GND	17	GND
8	PW_OK	18	-5V
9	5V_SB	19	5V
10	12V	20	5V

Connector: **CPUFAN, SYSFAN**

Type: 3-pin fan wafer connector

Pin	Description	Pin	Description	Pin	Description
1	Ground	2	+12V	3	Fan Control

---

## 2.7 VGA Interface

### 2.7.1 Analog VGA Interface

The board is integrated with Intel 845G GMCH chipset built-in Intel Extreme Graphics with 266 MHz VGA core, 256-bit 3D engine and Intel Dynamic Video Memory up to 64 MBytes shared with system memory. The CRT / analog VGA interface includes one external DB15 female connector on bracket on board.

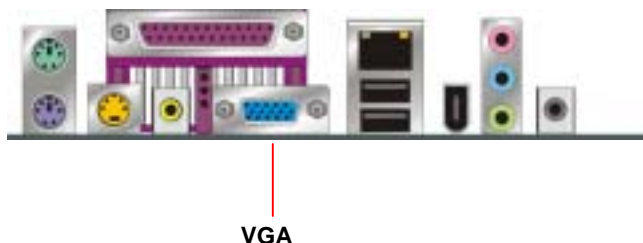

## 2.7.2 Digital VGA Interface

The board's digital video interface provides LVDS flat panel. The built-in 40-bit dual channel LVDS interface offers the economical solution for LVDS-based LCD display.

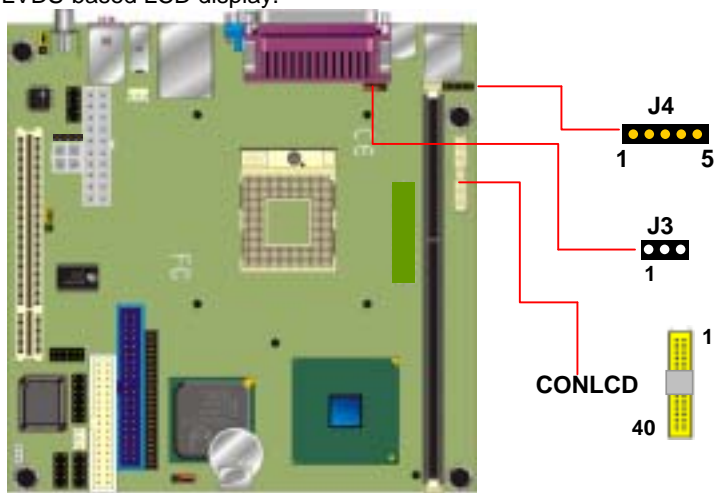

Connector: J4  
Type: 5-pin LVDS Power Header  
Header

Connector: J3  
Type: 3-pin Power select

Pin	Description
1	ENABKL
2	GND
3	GND
4	GND
5	+12V

Pin	Description
1	VCC
2	GND
3	VCC3

---

Connector: CONLCD

Type: onboard 40-pin connector for LVDS connector

<b>Pin</b>	<b>Signal</b>	<b>Pin</b>	<b>Signal</b>
2	LCDVCC	1	LCDVCC
4	GND	3	GND
6	ATX0-	5	BTX0-
8	ATX0+	7	BTX0+
10	GND	9	GND
12	ATX1-	11	BTX1-
14	ATX1+	13	BTX1+
16	GND	15	GND
18	ATX2-	17	BTX2-
20	ATX2+	19	BTX2+
22	GND	21	GND
24	ATXC-	23	BTX3-
26	ATXC+	25	BTX3+
28	GND	27	GND
30	ATX3-	29	BTXC-
32	ATX3+	31	BTXC+
34	GND	33	GND
36	PANELCLK	35	PANELCLK
38	PANELDATA	37	PANELDATA
40	HPD	39	HPD

---

## 2.8 Ethernet Interface

The **2801114** is integrated with Intel PRO/100+ Fast Ethernet interface at the type of 10Base-T/100Base-TX auto-switching Fast Ethernet with full duplex and IEEE 802.3U compliant. The **2801114** LAN interface is controlled by the Intel 82801DB ICH4 and 82562ET PHY, and connect with the external RJ45 connector on rear I/O panel.

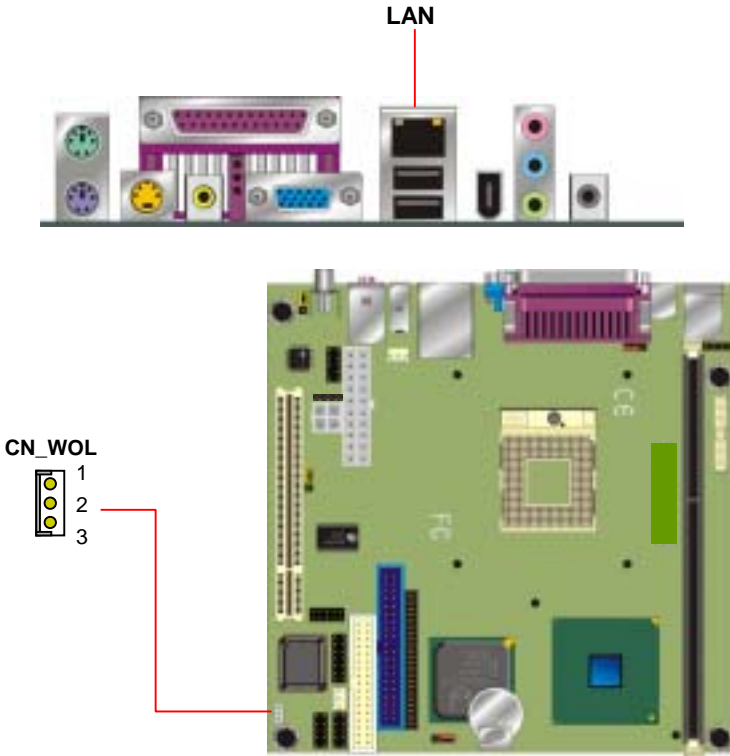

Connector: **CN\_WOL**



Type: onboard 3-pin (1 x 3) wafer connector

Pin	1	2	3
Description	WOL-Ctrl	Ground	+5V Standby

## 2.9 Audio Interface

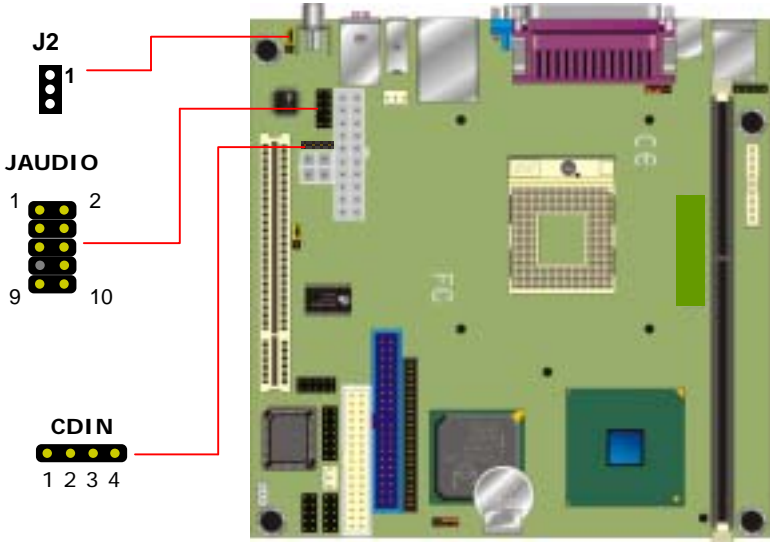
The **2801114** offers the AC97 3D audio with 5.1-channel and S/P DIF interface based on Intel ICH4 and Realtek ALC650 codec.



-  Red: Center / Mic-in
-  Blue: Rear / Line-in
-  Green: Front / Line-out

---

**Connector: JAUDIO**

Type: 10-pin (2 x 5) 2.54-pitch header

Pin	Description	Pin	Description
1	Line – Right	2	Ground
3	Line – Left	4	MIC
5	MIC	6	Ground
7	N/C	8	Line Out – Left
9	Line Out – Right	10	Ground

**Jumper: J2**

Type: onboard 3-pin header

J2	Mode
1-2	S/P DIF Output
2-3	S/P DIF Input

Default setting

**Connector: CDIN**

Type: 4-pin header

Pin	Description
1	CD – Left
2	Ground
3	Ground
4	CD – Right



## 2.10 Switch and Indicator

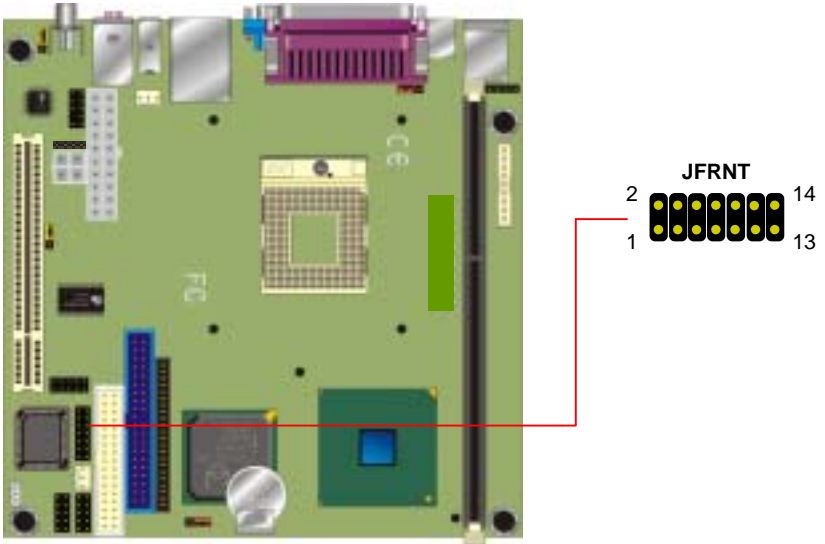

Connector: **JFRNT**

Type: onboard 14-pin (2 x 7) 2.54-pitch header

Function	Signal	PIN		Signal	Function
<b>IDE LED</b>	Vcc (+)	1	2	(+) Vcc	<b>Power LED</b>
	Active	3	4	N/C	
<b>Reset</b>	Reset	5	6	GND	
	GND	7	8	Vcc	
N/C		9	10	N/C	<b>Speaker</b>
<b>Power</b>	PWRBT	11	12	N/C	
<b>Button</b>	GND	13	14	SPKIN	

---

**Notes** (This page left blank intentionally)

A large, empty rectangular box with a thin black border, occupying most of the page. It is intended for the user to write notes.

---

## Chapter 3. BIOS Setup

The single board computer uses the Award BIOS for the system configuration. The Award BIOS in the single board computer is a customized version of the industrial standard BIOS for IBM PC AT-compatible computers. It supports Intel x86 and compatible CPU architecture based processors and computers. The BIOS provides critical low-level support for the system central processing, memory and I/O sub-systems.

The BIOS setup program of the single board computer let the customers modify the basic configuration setting. The settings are stored in a dedicated battery-backed memory, NVRAM, retains the information when the power is turned off. If the battery runs out of the power, then the settings of BIOS will come back to the default setting.

The BIOS section of the manual is subject to change without notice and is provided here for reference purpose only. The settings and configurations of the BIOS are current at the time of print, and therefore they may not be exactly the same as that displayed on your screen.

To activate CMOS Setup program, press <DEL> key immediately after you turn on the system. The following message “Press DEL to enter SETUP” should appear in the lower left hand corner of your screen. When you enter the CMOS Setup Utility, the Main Menu will be displayed as **Figure 3-1**. You can use arrow keys to select your function, press <Enter> key to accept the selection and enter the sub-menu.

**Figure 3-1.** CMOS Setup Utility Main Screen  
Phoenix – Award BIOS CMOS Setup Utility

>Standard CMOS Features	>Frequency/Voltage Control
>Advanced BIOS Features	Load Fail-Safe Defaults
>Advanced Chipset Features	Load Optimized Defaults
>Integrated Peripherals	Set Supervisor Password
>Power Management Setup	Set User Password
>PnP / PCI Configurations	Save & Exit Setup
>PC Health Status	Exit Without Saving
Esc : Quit	↑ ↓ → ← : Select Item
F10 : Save & Exit Setup	

---

Notes (This page left blank intentionally)

A large, empty rectangular box with a thin black border, occupying most of the page. It is intended for the user to write notes, as indicated by the text above it.

---

# Chapter 4 Audio Channel Configuration

In order to enable 5.1 channel, please follow the setup steps below:

1. Launch the **Control Panel**



2. Launch the **Sound Effect Manager**

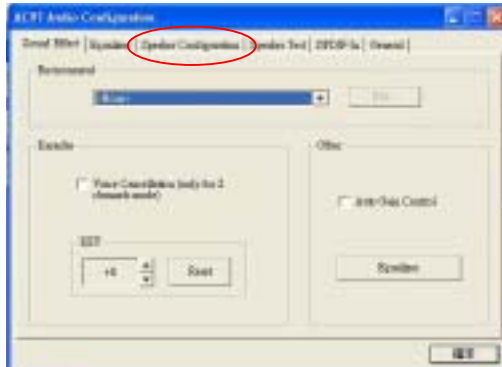

3. select **Speaker Configuration** and choose **6 channel mode for 5.1 speaker output**

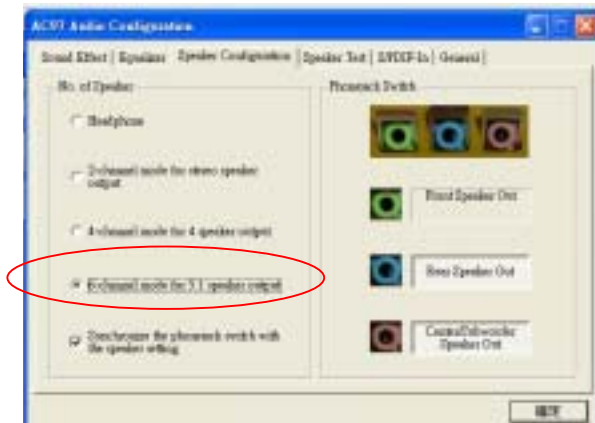

---

Notes (This page left blank intentionally)

A large, empty rectangular box with a thin black border, occupying most of the page. It is intended for the user to write notes.

---

## Appendix. A I/O Port Pin Assignment

### A.1 IDE Port

Connector: **IDE1**

Type: 40-pin (20 x 2) box header

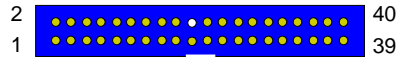

Pin	Description	Pin	Description
1	Reset	2	Ground
3	D7	4	D8
5	D6	6	D9
7	D5	8	D10
9	D4	10	D11
11	D3	12	D12
13	D2	14	D13
15	D1	16	D14
17	D0	18	D15
19	Ground	20	N/C
21	REQ	22	Ground
23	IOW-/STOP	24	Ground
25	IOR-/HDMARDY	26	Ground
27	IRDY/DDMARDY	28	IDESEL
29	DACK-	30	Ground
31	IRQ	32	N/C
33	A1	34	CBLID
35	A0	36	A2
37	CS0 (MASTER CS)	38	CS1 (SLAVE CS)
39	LED ACT-	40	Ground

Connector: **IDE2**

Type: 44-pin (22 x 2) box header



Pin	Description	Pin	Description
1	Reset	2	Ground
3	D7	4	D8
5	D6	6	D9
7	D5	8	D10
9	D4	10	D11
11	D3	12	D12
13	D2	14	D13
15	D1	16	D14
17	D0	18	D15
19	Ground	20	N/C
21	REQ	22	Ground
23	IOW-/STOP	24	Ground
25	IOR-/HDMARDY	26	Ground
27	IORDY/DDMARDY	28	Ground
29	DACK-	30	Ground
31	IRQ	32	N/C
33	A1	34	SD
35	A0	36	A2
37	CS1	38	CS3
39	ASP1	40	Ground
41	Vcc	42	Vcc
43	Ground	44	Ground



---

## A.2 Floppy Port

Connector: **FDC1**

Type: 34-pin (17 x 2) header

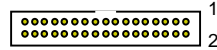

Pin	Description	Pin	Description
1	Ground	2	DRIVE DENSITY SELECT 0
3	Ground	4	DRIVE DENSITY SELECT 1
5	Ground	6	N/C
7	Ground	8	INDEX-
9	Ground	10	MOTOR ENABLE A-
11	Ground	12	DRIVER SELECT B-
13	Ground	14	DRIVER SELECT A-
15	Ground	16	MOTOR ENABLE B-
17	Ground	18	DIRECTION-
19	Ground	20	STEP-
21	Ground	22	WRITE DATA-
23	Ground	24	WRITE GATE-
25	Ground	26	TRACK 0-
27	Ground	28	WRITE PROTECT-
29	Ground	30	READ DATA-
31	Ground	32	HEAD SELECT-
33	Ground	34	DISK CHANGE-

## A.3 Serial Port

Connector: **JCOM1**

Type: 10-pin (5 x 2) header



Pin	Description	Pin	Description
1	DCD	2	RXD
3	TXD	4	DTR
5	Ground	6	DSR
7	RTS	8	CTS
9	RI	10	N/C

---

## A.4 USB Port

Connector: JUSB1

Type: 10-pin (5 x 2) header for dual USB Ports



Pin	Description	Pin	Description
1	Vcc	2	Vcc
3	Data0-	4	Data1-
5	Data0+	6	Data1+
7	Ground	8	Ground
9	N/C	10	N/C

## A.5 IrDA Port

Connector: JIR1

Type: 10-pin (5 x 2) header for SIR/CIR Ports



Pin	Description	Pin	Description
1	Vcc	6	N/C
2	N/C	7	CIRRX
3	IRRX	8	5V Standby
4	Ground	9	N/C
5	IRTX	10	N/C

## A.6 VGA Port

Connector: **VGA**

Type: 15-pin D-sub female connector on bracket

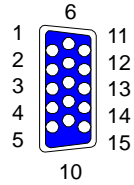

Pin	Description	Pin	Description	Pin	Description
1	RED	6	Ground	11	N/C
2	GREEN	7	Ground	12	5VCCA
3	BLUE	8	Ground	13	HSYNC
4	N/C	9	LVGA5V	14	VSYNC
5	Ground	10	Ground	15	5VCLK

## A.7 LAN Port

Connector: **LAN**

Type: RJ45 connector with LED on bracket

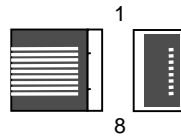

Pin	1	2	3	4	5	6	7	8
Description	TX+	TX-	RX+	N/C	N/C	RX-	N/C	N/C

---

Notes (This page left blank intentionally)

A large, empty rectangular box with a thin black border, occupying most of the page. It is intended for the user to write notes.

---

# Appendix B. Flash the BIOS

## B.1 BIOS Auto Flash Tool

The board is based on Award BIOS and can be updated easily by the BIOS auto flash tool. You can download the tool online at the address below:

<http://www.award.com>

File name of the tool is "awdfash.exe", it's the utility that can write the data into the BIOS flash chip and update the BIOS.

## B.2 Flash Method

1. Get the ".bin" file including the image of new BIOS you want to update.
2. Power on the system and flash the BIOS.
3. Re-start the system.

---

Notes (This page left blank intentionally)

A large, empty rectangular box with a thin black border, occupying most of the page. It is intended for the user to write notes, as indicated by the text above it.

---

## Appendix C. System Resources

### C.1 I/O Port Address Map

<b>Address Range</b>	<b>Device</b>
0000-000F	PC Compatible Eisa/Isa HAL
0020-0021	PC Compatible Eisa/Isa HAL
0040-0043	PC Compatible Eisa/Isa HAL
0048-0048	PC Compatible Eisa/Isa HAL
0060-0060	i8042prt
0061-0064	PC Compatible Eisa/Isa HAL
0064-0064	i8042prt
0070-0071	PC Compatible Eisa/Isa HAL
0080-008F	PC Compatible Eisa/Isa HAL
0092-0092	PC Compatible Eisa/Isa HAL
00A0-00A1	PC Compatible Eisa/Isa HAL
00C0-00CF	PC Compatible Eisa/Isa HAL
00F0-00FF	PC Compatible Eisa/Isa HAL
01CE-01CF	VgaSavve
01F0-01F7	atapi
02F8-02FE	Serial
0378-037A	Parport
03B0-03BB	VgaSavve
03C0-03DF	VgaSavve
03F0-03F5	Floppy
03F6-03F6	atapi
03F7-03F7	Floppy
03F8-03FE	Serial
E000-E0FF	alcxnt
E400-E43F	alcxnt

---

---

## C.2 Memory Address Map

Range	Device
0xCBA00-0xCBFFF	System board
0xF0000-0xF7FFF	System board
0xF8000-0xFBFFF	System board
0xFC000-0xFFFFF	System board
0xF7F0000-0xF7FFFFFF	System board
0x0000-0x9FFFF	System board
0x100000-0xF7EFFFF	System board
0xFEC00000-0xFEC00FFF	System board
0xFEE00000-0xFEE00FFF	System board
0xFFB00000-0xFFBFFFFF	System board
0xFFFF00000-0xFFFFFFFFFF	System board
0xE0000-0xEFFFF	System board
0xA0000-0xBFFFF	PCI bus
0xA0000-0xBFFFF	Intel(R) 82845G Graphics Controller
0xC0000-0xDFFFF	PCI bus
0xF800000-0xFEBFFFFF	PCI bus
0xE0000000-0xE7FFFFFFF	Intel(R) 82845G Graphics Controller
0xEC100000-0xEC17FFFF	Intel(R) 82845G Graphics Controller
0xEC180000-0xEC1803FF	Intel (R) USB Enhanced Host Controller (ICH4)
0xEC000000-0xEC000FFF	Intel(R) PRO/100 VE Network Connection
0xEC001000-0xEC001FFF	OHCI Compliant IEEE 1394 Host Controller
0xFEBFFC00-0xFEBFFFFF	Intel(R) 82801DB Ultra ATA Storage Controller - 24CB
0xEC181000-0xEC1811FF	Avance AC'97 Audio
0xEC182000-0xEC1820FF	Avance AC'97 Audio

---



---

## C.3 System IRQ and DMA Resource

### C3.1 IRQ

IRQ Number	Device
0	System timer
1	Standard 101/102-Key or Microsoft Natural Keyboard
2	Programmable Interrupt Controller
3	Communications Port (COM2)
4	Communications Port (COM1)
5	ACPI IRQ Holder for PCI IRQ Steering
5	Advance AC97 Audio
5	Intel(R) 82801DB/DBM SMBus Controller - 24C3
5	PCI OHCI Compliant IEEE 1394 Host Controller
6	Standard Floppy Disk Controller
7	Parallel Port (LPT1)
8	System CMOS / Real Time Clock
9	Microsoft ACPI-Compliant System
9	Intel(R) USB Enhanced Host Controller (ICH4)
9	SCI IRQ Used by ACPI Bus
10	ACPI IRQ Holder for PCI IRQ Steering
10	ACPI IRQ Holder for PCI IRQ Steering
10	Intel(R) 82801DB/DBM USB Universal Host Controller – 24C4
10	Intel(R) 82801DB/DBM USB Universal Host Controller – 24C2
10	Intel(R) 82845G/GL Graphics Controller
11	ACPI IRQ Holder for PCI IRQ Steering
11	Intel(R) PRO/100 VE Network Connection
11	Intel(R) 82801DB/DBM USB Universal Host Controller – 24C7
12	PS/2 Compatible Mouse Port
13	Numeric Data Processor
14	Intel(R) 82801DB Ultra ATA Storage Controller – 24CB
14	Primary IDE Controller (Dual FIFO)
15	Intel(R) 82801DB Ultra ATA Storage Controller – 24CB
15	Secondary IDE Controller (Dual FIFO)

---

---

### **C3.2 DMA**

<b>Channel</b>	<b>Device</b>
0	(free)
1	(free)
2	Standard Floppy Disk Controller
3	(free)
4	Direct Memory Access Controller
5	(free)
6	(free)
7	(free)

---

---

Notes (This page left blank intentionally)

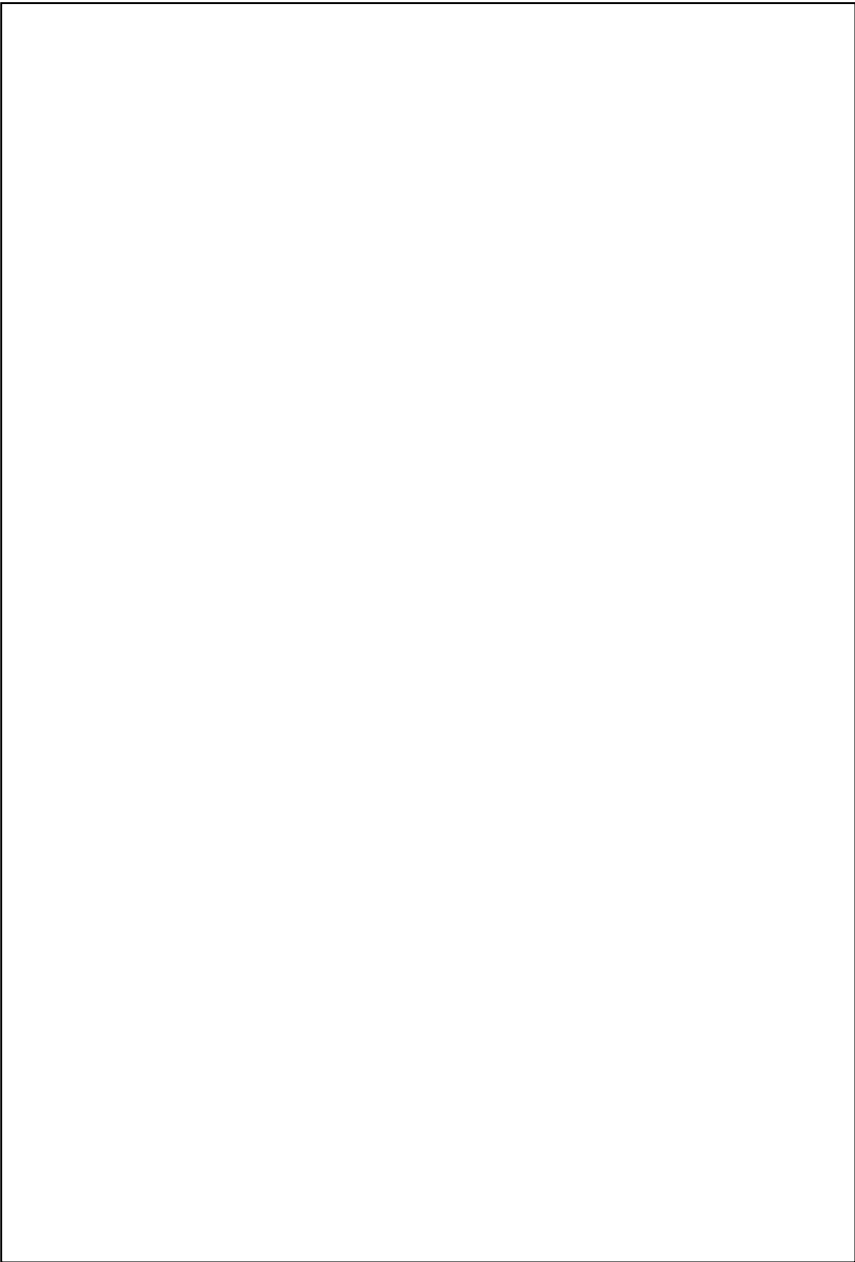

---

## Contact Information

Any adviser or comment about our products and service, or anything we can help you please don't hesitate to contact with us. We will do our best service for you.



---

### Global American Inc.

Address 17 Hampshire Drive Hudson  
NH 03051  
USA

TEL 1-603-886-3900

FAX 1-603-886-4545

Website: [www.globalamericaninc.com](http://www.globalamericaninc.com)

---