



**2804060**  
**Series**

(Industrial Board)

# **INSTALLATION GUIDE**

**COPYRIGHT®**

All rights reserved. The information contained in this guide has been validated and reviewed for accuracy. No patent liability is assumed with respect to the use of the information contained herein. While every precaution has been taken in the preparation of this guide, the Manufacturer assumes no responsibility for errors or omissions.

No part of this publication may be reproduced, stored in a retrieval system, or transmitted in any form or by any means, electronic, mechanical, photocopying, recording, or otherwise, without the prior written permission of Manufacturer.

**TRADEMARK™**

Intel®, Pentium® and Celeron® are registered trademarks of Intel® Corporation.

Microsoft® and Windows® are registered trademarks of Microsoft Corporation.

All products and company names are trademarks or registered trademarks of their respective holders.

These specifications are subject to change without notice.

Installation Guide Revision A0  
June 2004

# CONTENTS

<b>SECTION 1</b>	<b>INTRODUCTION</b>	<b>1</b>
1.1	Unpacking 2804060 Series	1
1.2	Description	2
1.3	Features	2
1.3.1	Graphic & Ethernet	2
1.3.2	Ultra ATA/66/100	3
1.3.3	Hardware Monitoring	3
1.3.4	I/O Shield Connector	3
1.3.5	Power-On/Off	4
1.3.6	2804060 Series Overview	4
1.3.7	System Block Diagram	5
1.4	Specifications	6
<b>SECTION 2</b>	<b>INSTALLATIONS</b>	<b>8</b>
2.1	System Installation	8
2.1.1	CPU Installation	8
2.1.2	Heat Sink Installation	9
2.1.3	Memory Module Installation	10
2.1.4	Setting Jumper and DIP Switches	12
2.2	Board Layout	13
2.3	Jumper Setting	14
2.4	Connector's Description	17

# CONTENTS

<b>SECTION 3</b>	<b>AWARD BIOS SETUP</b>	<b>35</b>
3.1	BIOS Instructions	35
3.2	Main Menu	36
3.3	Standard CMOS Features	38
3.4	IDE Adapters	40
3.5	Advanced BIOS Features	42
3.6	Advanced Chipset Features	46
3.7	Integrated Peripherals	49
3.8	Power Management Setup	54
3.9	PnP/PCI Configurations	58
3.10	PC Health Status	59
3.11	Frequency/Voltage Control	61
3.12	Load Fail-Safe Default	63
3.13	Load Optimized Defaults	63
3.14	Supervisor/User Password Setting	64
3.15	Exit Selecting	65
3.16	Contact Information	66



The graphic consists of three overlapping rectangular boxes. The top box is white with a black border and contains the text 'SECTION 1' in bold black font. The two boxes below it are slightly offset to the right and bottom, creating a layered effect.

**SECTION 1**

## **INTRODUCTION**

### **1.1 Unpacking 2804060 Series**

1. Take out the 2804060 series unit from the carton box, check if the unit is properly secure in the plastic bag.
2. Check the contents of the carton box:
  - ı Industrial Board
  - ı Driver CD/Manual
  - ı Floppy ribbon cable
  - ı ATA-66/100 HDD ribbon cable
  - ı I/O Shield
  - ı COM2 ribbon cable (1 Set) (for RS-232/422/485)
  - ı Extend to front panel cable (for K/B & M/S)

## 1.2 Description

The 2804060 Series combines the high performance and exceptional value of Intel® 845GV chipset with a full-featured, new generation, industrial board. The Intel® advanced 845GV chipset support regular socket 478-pins Intel® Pentium® 4 / Celeron® processors of 1.3GHz and up to 3.06GHz, that memory base on the FSB 400/533MHz operation supports DDR SDRAM interface. In the meantime, the 845GV chipset integrated the VGA function and an external graphics device on AGP (845GV support ADD card only). The IP-4GVI83 system memory size can be up to 2GB DDR memory, onboard Intel® 82562ET Ethernet controller (support 10/100 Base-TX Ethernet), Audio and with 2 COM ports, besides the IP-4GVI83 add one 6-pins connector that can extend to front of chassis for KB & MS.

The 82801DB I/O Controller Hub (ICH4) employs the Intel® Accelerated Hub Architecture to make a direct connection from the graphics and memory to the integrated Ethernet controller, the IDE controllers (ATA/33 or ATA/66 or ATA/100), six USB ports that are supported USB 1.1/2.0 standard meets the performance, stability and reliability requirements.

The industrial board - 2804060 is suitable and valuable for all the industry applications, which also well support with the Windows® 98 / 2000 / XP / NT and Linux® operation system.

## 1.3 Features

### 1.3.1 Graphic & Ethernet

The 2804060 is base on the Intel® 845GV chipset, offers users the integration graphic, Ethernet, Audio function. The features of chipset are as below:

- j Enhanced integrated graphics & system performance:
  - Support FSB 400/533 MHz
- j Memory:
  - SDRAM PC133, DDR 266/333
  - 2.0GB Max. Memory
  - 2 DIMM, Non-ECC

- j IO Connectivity - ICH4:
  - 6 Hi-Speed USB2.0 ports
  - AC'97 Codec
  - 2 Serial ports

### 1.3.2 Ultra ATA/66/100

The ICH4 provides two channel Ultra ATA/66/100 Bus Master IDE controller, that support Ultra ATA/66/100 protocols, perfect for such demanding applications as real-time video, multimedia, and high performance operating system. A new IDE cable is required for Ultra ATA/66/100. This cable is an 80-conductor cable; however the connectors are, of course, backwards compatible with ATA/33.

### 1.3.3 Hardware Monitoring

Hardware monitoring allows you to monitor various aspects of your systems operations and status. The features include CPU temperature, voltage and RPM of fan.

### 1.3.4 I/O Shield Connector

The board is equipped with an I/O back panel. Please use the appropriate I/O shield (figure 1).

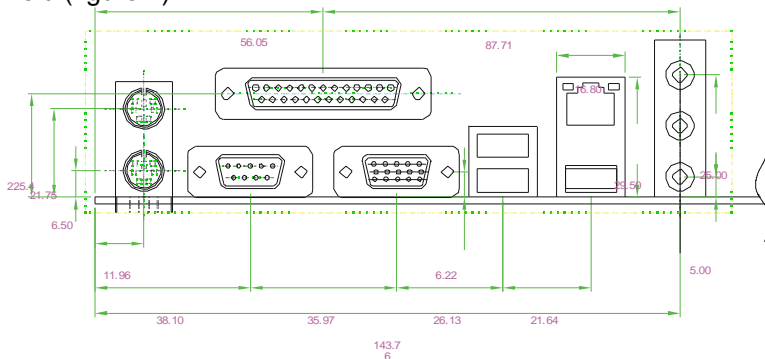

Figure 1: I/O back panel layout



### 1.3.5 Power-On/Off (Remote)

The board has a single 20-pins connector for ATX power supplies. For ATX power supplies that support the Remote On/Off feature, this should be connected to the systems front panel for system Power On/Off button. The systems power On/Off button should be a momentary button that is normally open.

The board has been designed with "Soft Off" functions. You can turn off the system from one of two sources: The first is the front panel Power On/Off the button, and the other is the "Soft Off" function (coming from the M/B onboard circuit controller) that can be controlled by the operating system such as Windows® 98/SE/ME/2000 or Windows® XP.

### 1.3.6 IP-4GVI83 Series Overview

Function / Model	IP-4GVI83
i Chipset	Intel® 845GV
i LCD Function	/
i VGA Function	€
i SCSI Function	/
i Ethernet Function	€
i Audio Function	€
i Two EIDE Interface	€
i One Floppy Interface	€
i One Parallel Port	€
i AGP Slot	1 (for ADD card only)
i PCI Slots	4
i ISA Slots	3
i Serial Port	2
i USB 2.0 Port	6 (four ports on rear panel)
i Fan Connector	3
i External KB/MS Connector	€

### 1.3.7 System Block Diagram

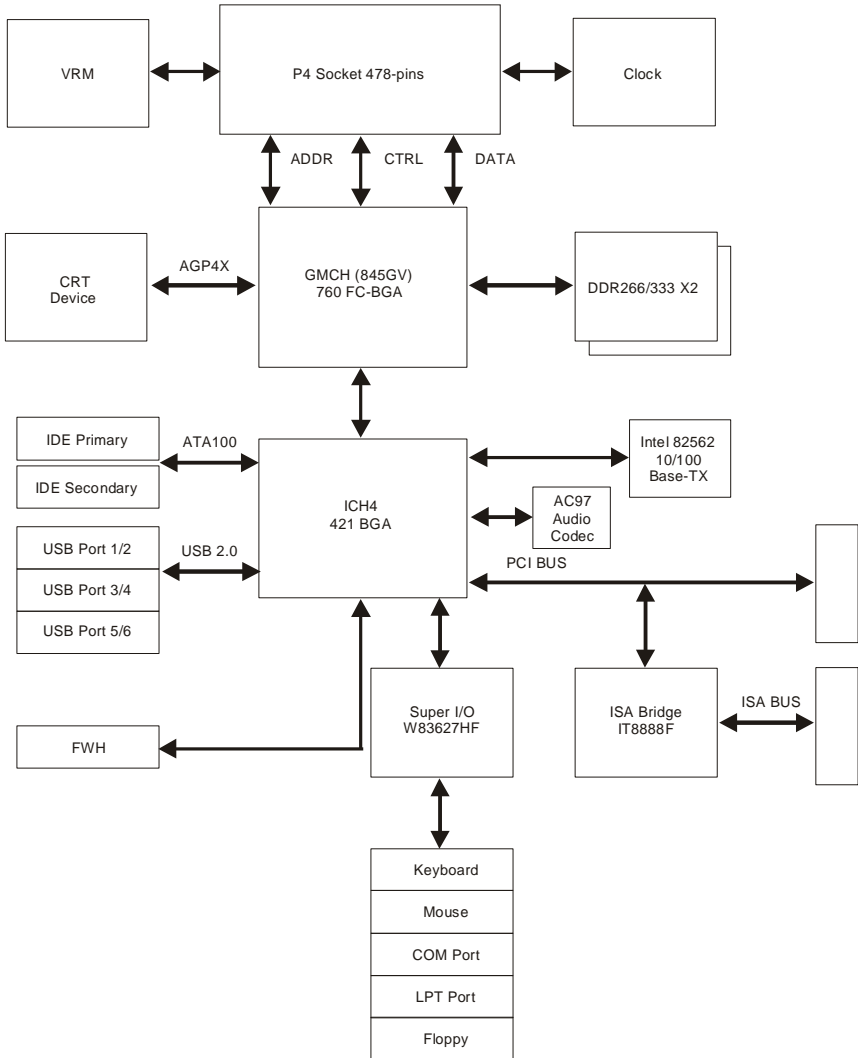

Figure 2: System Block Diagram

## 1.4 Specifications

### j **Processor:**

- Intel® Pentium® 4/Celeron™ processor with socket 478-pins package, Processor operating at 1.3GHz and up to 3.06GHz
- System bus frequency at 400/533 MHz FSB

### j **Chipset:**

- Intel® 82845GV + ICH4 AGPset

### j **DRAM Module:**

- Two 184-pins socket
- For DDR 266/333 SDRAM memory
- Support DDR SDRAM up to 2GB (Max.)

### j **VGA Function:**

- Intel® 845GV Chipset integrated graphic controller
- Onboard one 15-pins VGA connector

### j **LAN Function:**

- Intel® 82562ET Ethernet controller
- For 10/100Base-TX Ethernet
- Onboard one RJ-45 Ethernet connector
- 

### j **Audio Function:**

- AC97 audio codec

### j **External Connector:**

- One 6-pins connector for extend to front panel K/B & M/S

### j **Expansion Slot:**

- 1 x AGP slot (for ADD card only)
- 4 x PCI slots
- 3 x ISA slots

### j **Onboard I/O:**

- On-Chip I/O integrated with K/B, M/S, FDD, Parallel and Serial, Fast IR and Power-ON controllers

j **Onboard PCI / IDE:**

- Intel® ICH4 south bridge controller
- PCI rev2.2 Compliant
- ACPI Compliant Power Management
- PCI Bus IDE Port with PIO /Ultra DMA-100 x 2 (up to 4 devices)

j **Rear I/O Connectors:**

- PS/2 Mouse and PS/2 style Keyboard
- D-Sub 25-pins Printer port connector
- D-Sub 9-pins COM1 Serial port connector for RS-232
- D-Sub 15-pins VGA connector
- 2 x USB2.0 connectors
- RJ-45 Ethernet and 2 x USB2.0 connectors
- Audio for Line-In, Line-Out, MIC phone jack

j **Internal I/O Connectors (pin-header):**

- 1 x serial port, COM2 for RS-232 / 422 / 485  
(for optional serial cable with bracket)
- 2 x USB2.0 connectors (for optional USB cable with bracket)

j **BIOS:**

- Award Plug & Play BIOS

j **Form Factor:**

- 12" x 8.7" (305 x 220mm) ATX Size

j **Weight:**

- 1.44lb (650g)

## SECTION 2

### INSTALLATIONS

#### 2.1 System Installation

##### 2.1.1 CPU Installation

Carefully follow the steps below in order to install the CPU:

1. Check and confirm that the jumpers are correctly set for the CPU you are going to install (figure 3).
2. Lift the releasing lever of the Socket 478.
3. Align the pin of the CPU against the pinholes of the Socket 478. Be sure to pay attention to the orientation of the CPU.

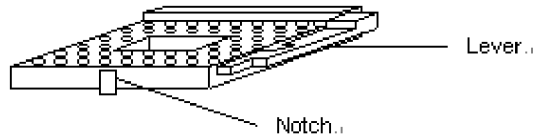

Figure 3: CPU Socket

4. Push down the CPU into the Socket 478.
5. Push down the release lever and lock it against the key hook.
6. Hook the hole in ZIF clip for the CPU cooling fan onto the notch on the socket 478.
7. Place the CPU cooling fan atop the CPU surface.
8. Push down the opposite side of the ZIF clip and hook it.
9. Slide the head of the clip to left and lock it.
10. Connect the cooling fan cable to the socket as shown below. Be careful not to place the cable on the CPU cooling fan.

**Removing a CPU:**

1. Before removing the CPU, turn off the 2804060 Series power; then wait for about 20 minutes until the heat radiation plate of the cooling fan and the CPU cools down.
2. To remove the CPU, lift the releasing lever of the Socket 478.

Note: The CPU and the heat radiation plate are hot. They may cause burns.

**To remove the CPU, reverse the installation steps.**

**2.1.2 Heat Sink & Retention Module Installation**

Make sure that good contact is made between the processors and the heat sinks & fan. Insufficient contact, incorrect types of heat sinks, fans, or thermal compound used or improper amount of thermal compound applied on the CPU die can cause the processors to overheat, which may crash the system.

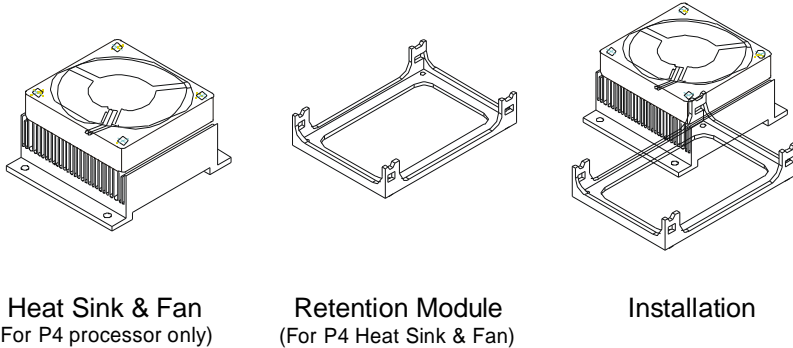

Figure 4: Heat Sink & Retention Module Installation

### 2.1.3 Memory Module Installation

Figure 5 display the notch marks and what they should look like on your DIMM memory module.

DIMMs have 184-pins and two notches that will match with the onboard DIMM socket. DIMM modules are installed by placing the chip firmly into the socket at a 90-degree angle and pressing straight down (figure 6) until it fits tightly into the DIMM socket.

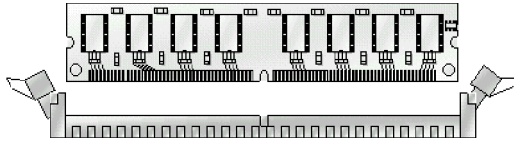

Figure 5: DIMM Memory and 184-pins Socket

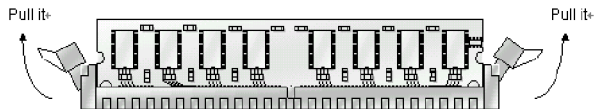

Figure 6: Memory Installation

Carefully follow the steps below in order to install the DIMMs:

1. To avoid generating static electricity and damaging the DIMM, ground yourself by touching a grounded metal surface or using a ground scrap before you touch the DIMM.
2. Do not touch the connector of the DIMM. Dirt residue may cause a malfunction.
3. Hold the DIMM with its notch to the front side of the 2804060 Series and insert it completely into the socket. A DIMM should be inserted into the inner socket first. Guiding the hole at each end of the DIMM over the retaining post at each end of the DIMM socket.
4. If you install two DIMMs, install the second DIMM using the same procedure as above.
5. If DIMM does not go in smoothly, do not force it. Pull it all the way out and try again.
6. Make sure the DIMM is properly installed and locked by the tabs on both sides of the socket.

**Removing a DIMM:**

To remove the DIMM, use your fingers or a small screwdriver to carefully push away the plastic tabs that secure the DIMM at each end. Lift it out of the socket.

**Make sure you store the DIMM in an anti-static bag and must be populated the same size and manufactory of memory modules.**



### 2.1.4 Setting Jumpers and DIP Switches

There are jumpers and DIP-switches on the system board of the 2804060 Series. You can set the jumpers to make the necessary operations.

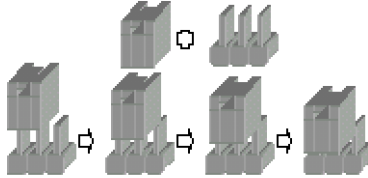
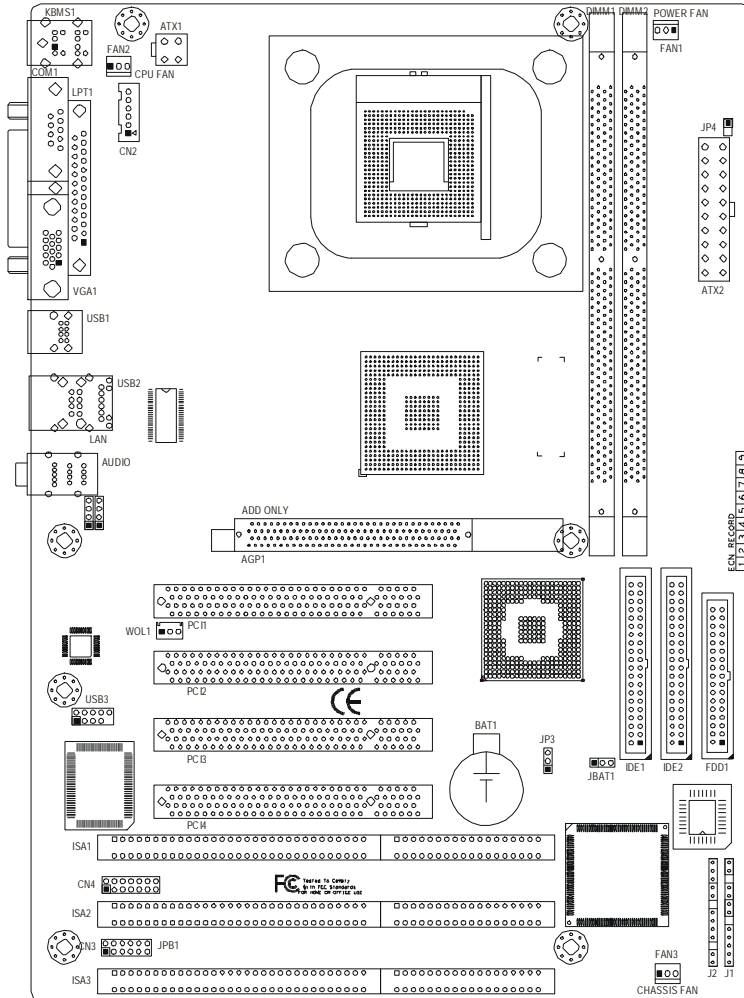

Figure 7: Jumper Connector

For any three-pin jumpers (Figure 7), the jumper setting is 1-2 when the jumper connects pin 1 and 2. The setting is 2-3 when pin 2 and 3 are connected and so on. You see a number “1” and a “3” printed on the circuit board to identify these pins. And also, there is a second way of indication – one of the lines surrounding jumpers is thick, which indicates pin NO.1.

To move a jumper from one position to another, use needle-nose pliers or tweezers to pull the pin cap off the pins and move it to the desired position.

## 2.2 Board Layout Jumper & Connector Location



## 2.3 Jumper Setting

### Table for Jumper Location Description:

Use the information in the following table to change the jumpers and the DIP switches.

<b>Jumpers</b>	<b>Functions</b>
JP3	Watchdog Timer Setting Select
JP4	Power Management Setting Select
JBAT1	Clear CMOS Setting Select
JPB1	COM2 Port Setting Select

In order to set up the correct configuration, here is the description about how to set the jumpers to enable/disable or change functions. All jumpers' location please refer to jumper location diagram.

- **Watchdog Timer Setting Select: JP3**

Function	JP3
NMI (Default)	1-2
Reset System	2-3

∪ **Location:**

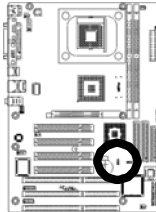

- **Power Management Setting Select: JP4**

Function	JP4
ACPI Mode (Default)	On
APM Mode	Off

∪ **Location:**

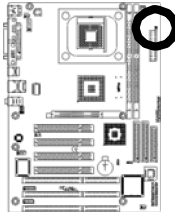

- **Clear CMOS Setting Select: JBAT1**

Function	JBAT1
Normal (Default)	1-2
Clear CMOS	2-3

y **Location:**

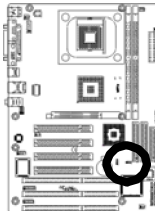

- **COM2 Port Setting Select: JPB1**

Function	JPB1					
	1-2	3-4	5-6	7-8	9-10	11-12
RS-232	Off	Off	Off	Off	Off	On
RS-422	On (Term.)	On (Term.)	Off	On	On	Off
RS-485	On (Term.)	On (Term.)	On	Off	On	Off

y **Location:**

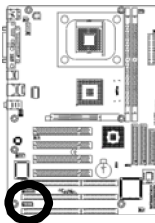

## 2.4 Connector's Description

### Connector Location

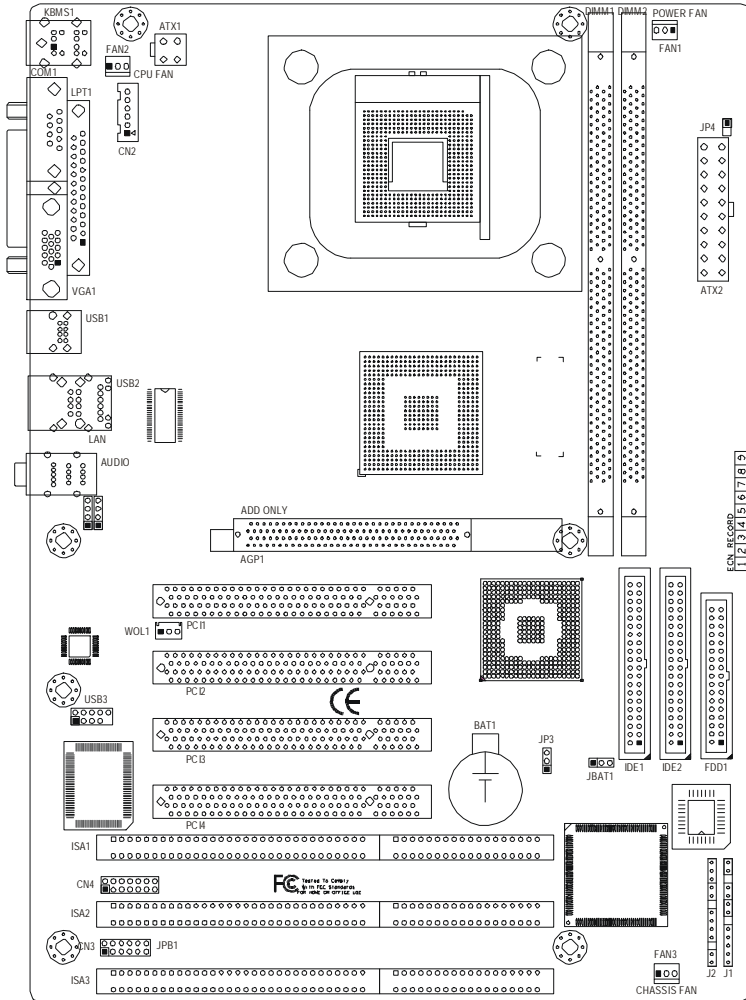

**Table for Connector's Location Description:**

Use the information in the following table to change the connector.

<b>Connectors</b>	<b>Functions</b>
IDE1	Primary IDE Connector
IDE2	Secondary IDE Connector
FDD1	Floppy Disk Connector
ATX2	ATX Power Connector
FAN1	Power Fan Power Connector
ATX1	ATX 12V Power Connector
FAN2	CPU Fan Power Connector
CN2	External K/B & M/S Connector
KBMS1	PS/2 Keyboard & Mouse Connector
COM1	COM1 RS-232 Serial Port Connector
LPT1	Parallel Port Connector
VGA1	CRT VGA Port Connector
USB1	USB 0/1 Connector
LAN	Ethernet RJ-45 Connector
USB2	USB 2/3 Connector
AUDIO	Audio Port Connector
CDIN1	CD_IN Connector
AUXIN1	AUX_IN Connector
WOL1	Wake On LAN Connector
USB3	USB 4/5 (Pin-Header) Connector
CN4	COM2 RS-232/422/485 Serial Port Connector
FAN3	Chassis Fan Power Connector
J1/J2	System Panel Indicate Connector

• **Primary IDE Connector (40-pins 2.54mm Pitch Pin-Header with Housing): IDE1**

Pin #	Assignment	Pin #	Assignment
1	Reset IDE	2	Ground
3	Host Data 7	4	Host Data 8
5	Host Data 6	6	Host Data 9
7	Host Data 5	8	Host Data 10
9	Host Data 4	10	Host Data 11
11	Host Data 3	12	Host Data 12
13	Host Data 2	14	Host Data 13
15	Host Data 1	16	Host Data 14
17	Host Data 0	18	Host Data 15
19	Ground	20	NC
21	DRQ 0	22	Ground
23	Host IOW	24	Ground
25	Host IOR	26	Ground
27	IOCHRDY	28	Host ALE
29	DACK 0	30	Ground
31	IRQ 14	32	No Connect
33	Address 1	34	No Connect
35	Address 0	36	Address 2
37	Chip Select 0	38	Chip Select 1
39	Activity	40	Ground

γ **Figure:**

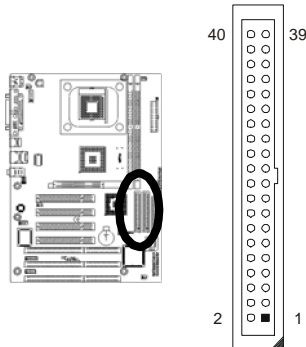



- **Secondary IDE Connector (40-pins 2.54mm Pitch Pin-Header with Housing): IDE2**

Pin #	Assignment	Pin #	Assignment
1	Reset IDE	2	Ground
3	Host Data 7	4	Host Data 8
5	Host Data 6	6	Host Data 9
7	Host Data 5	8	Host Data 10
9	Host Data 4	10	Host Data 11
11	Host Data 3	12	Host Data 12
13	Host Data 2	14	Host Data 13
15	Host Data 1	16	Host Data 14
17	Host Data 0	18	Host Data 15
19	Ground	20	NC
21	DRQ 1	22	Ground
23	Host IOW	24	Ground
25	Host IOR	26	Ground
27	IOCHRDY	28	Host ALE
29	DACK 1	30	Ground
31	IRQ 15	32	No Connect
33	Address 1	34	No Connect
35	Address 0	36	Address 2
37	Chip Select 0	38	Chip Select 1
39	Activity	40	Ground

γ **Figure:**

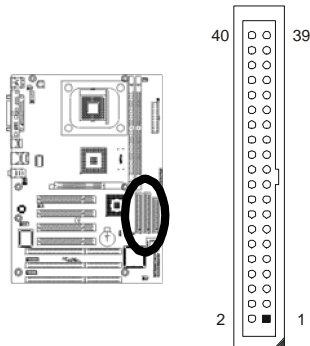

• **Floppy Disk Connector (34-pins 2.54mm Pitch Pin-Header with Housing): FDD1**

Pin #	Assignment	Pin #	Assignment
1	Ground	2	Drive Density Selection
3	Ground	4	No Connect
5	Ground	6	Drive Density Selection
7	Ground	8	Index
9	Ground	10	Motor Enable 0
11	Ground	12	Drive Select 1
13	Ground	14	Drive Select 0
15	Ground	16	Motor Enable 1
17	Ground	18	Direction
19	Ground	20	Step
21	Ground	22	Write Data
23	Ground	24	Write Gate
25	Ground	26	Track 00
27	Ground	28	Write Protect
29	Ground	30	Read Data
31	Ground	32	Side 1 Select
33	Ground	34	Diskette Change

Figure:

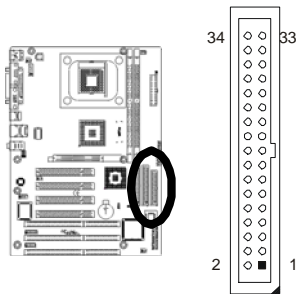

• **ATX Power Connector: ATX2**

Pin #	Assignment	Pin #	Assignment
1	+3.3V	11	+3.3V
2	+3.3V	12	-12V
3	Ground	13	Ground
4	+5V	14	PS-ON
5	Ground	15	Ground
6	+5V	16	Ground
7	Ground	17	Ground
8	PW-OK	18	-5V
9	5VSB	19	+5V
10	+12v	20	+5V

γ **Figure:**

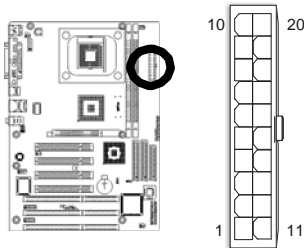

• **Power Fan Power Connector: FAN1**

Pin #	Assignment
1	Ground
2	+12V
3	Sense

γ **Figure:**

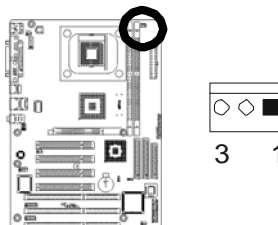

• **ATX 12V Power Connector: ATX1**

Pin #	Assignment	Pin #	Assignment
1	Ground	2	Ground
3	+12V	4	+12V

γ **Figure:**

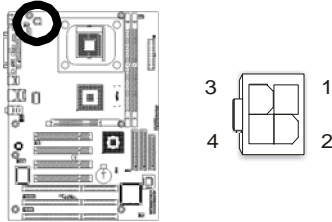

• **CPU Fan Power Connector: FAN2**

Pin #	Assignment
1	Ground
2	+12V
3	Sense

γ **Figure:**

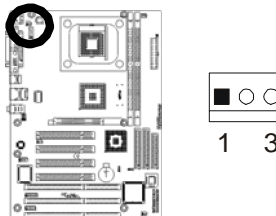

- **External K/B & M/S Connector (6-pin Male): CN2**

Pin #	Assignment
1	MS Clock
2	MS Data
3	KB Clock
4	KB Data
5	Ground
6	VCC

Figure:

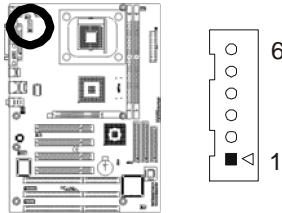

- **PS/2 Keyboard Connector (6-pins Green Mini Din): KBMS1**

Pin #	Assignment	Pin #	Assignment
1	Keyboard data	2	NC
3	Ground	4	+5V
5	Keyboard clock	6	NC

Figure:

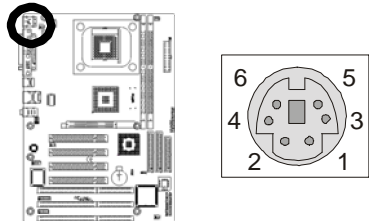

• **PS/2 Mouse Connector (6-pins Purple Mini Din): KBMS1**

Pin #	Assignment	Pin #	Assignment
1	Mouse data	2	NC
3	Ground	4	+5V
5	Mouse clock	6	NC

γ **Figure:**

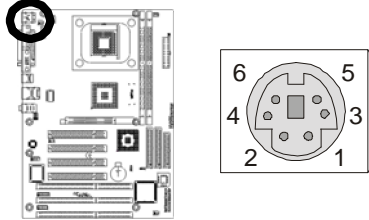

• **COM1 RS-232 Serial Port Connector (D-Sub 9-pins Male): COM1**

Pin #	Assignment	Pin #	Assignment
1	DCD (Data Carrier Detect)	6	DSR (Data Set Ready)
2	RXD (Receive Data)	7	RTS (Request to Send)
3	TXD (Transmit Data)	8	CTS (Clear to Send)
4	DTR (Data Terminal Ready)	9	RI (Ring Indicator)
5	Ground		

γ **Figure:**

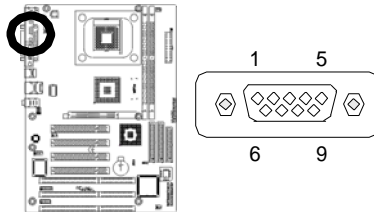

- **Parallel Port Connector (D-Sub 25-pins Male): LPT1**

Pin #	Assignment	Pin #	Assignment
1	Line Printer Strobe	14	Auto Feed
2	PD 0, Parallel Data 0	15	Error
3	PD 1, Parallel Data 1	16	Initialize
4	PD 2, Parallel Data 2	17	Select
5	PD 3, Parallel Data 3	18	Ground
6	PD 4, Parallel Data 4	19	Ground
7	PD 5, Parallel Data 5	20	Ground
8	PD 6, Parallel Data 6	21	Ground
9	PD 7, Parallel Data 7	22	Ground
10	ACK, Acknowledge	23	Ground
11	Busy	24	Ground
12	Paper Empty	25	Ground
13	Select	26	N/A

γ **Figure:**

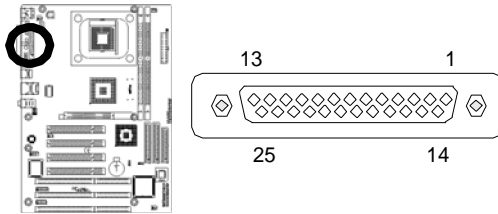

• **CRT VGA Port Connector (D-SUB 15-pins Female): VGA1**

Pin #	Assignment	Pin #	Assignment
1	Red	2	Green
3	Blue	4	NC
5	Ground	6	Ground
7	Ground	8	Ground
9	VCC	10	Ground
11	NC	12	DDData
13	HSync	14	VSynC
15	DDClk		

γ **Figure:**

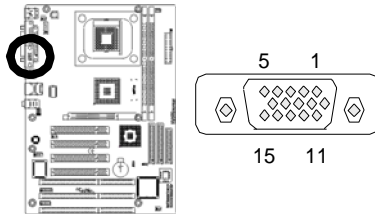

• **USB 0/1 Connector (4-pins Female): USB1**

Pin #	Assignment	Pin #	Assignment
1a	VCC	1b	VCC
2a	USB0 -	2b	USB1 -
3a	USB0 +	3b	USB1 +
4a	Ground	4b	Ground

γ **Figure:**

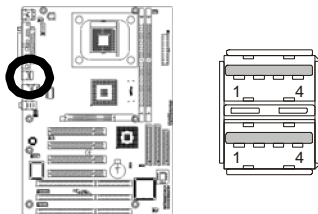



- **Ethernet (82562ET) RJ-45 Connector (RJ-45 Phone-Jack): LAN**

Pin #	Assignment	Pin #	Assignment
1	Transmit output (+)	5	NC
2	Transmit output (-)	6	Receive input (-)
3	Receive input (+)	7	NC
4	NC	8	NC

∪ **Figure:**

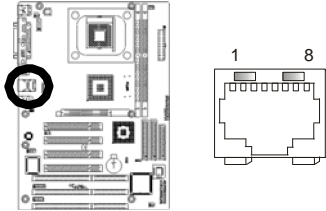

- **USB 2/3 Connector (4-pins Female): USB2**

Pin #	Assignment	Pin #	Assignment
1a	VCC	1b	VCC
2a	USB2 -	2b	USB3 -
3a	USB2 +	3b	USB3 +
4a	Ground	4b	Ground

∪ **Figure:**

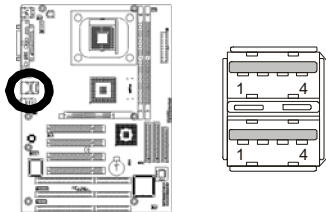

- **Audio Port Connector: AUDIO**

Pin #	Assignment
Blue	Line-In
Green	Line-Out
Red	Mic-In

γ **Figure:**

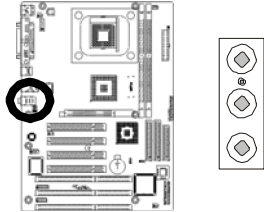

- **CD\_IN Connector: CDIN1**

Pin #	Assignment
1	Left CD_IN
2	Ground
3	Ground
4	Right CD_IN

γ **Figure:**

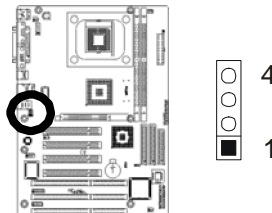

- **AUX\_IN Connector: AUXIN1**

Pin #	Assignment
1	Left AUX_IN
2	Ground
3	Ground
4	Right AUX_IN

Figure:

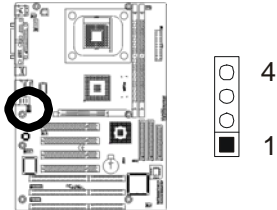

- **Wake On LAN Connector: WOL1**

Pin #	Assignment
1	5VSB
2	Ground
3	Data

Figure:

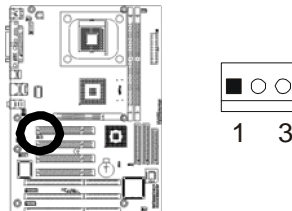

• **USB 4/5 Connector (9-pins Pin-Header): USB3**

Pin #	Assignment	Pin #	Assignment
1	VCC	2	VCC
3	USB4 -	4	USB5 -
5	USB4 +	6	USB5 +
7	Ground	8	Ground
9	---	10	NC

γ **Figure:**

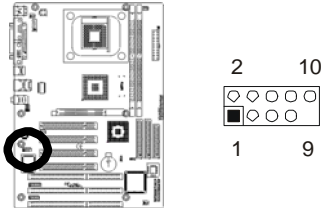

• **COM2 RS-232/422/485 Serial Port Connector (14-pins Pin-Header):  
CN4**

Pin #	Assignment	Pin #	Assignment
1	DCD (Data Carrier Detect)	2	RXD (Receive Data)
3	TXD (Transmit Data)	4	DTR (Data Terminal Ready)
5	Ground	6	DSR (Data Set Ready)
7	RTS (Request to Send)	8	CTS (Clear to Send)
9	RI (Ring Indicator)	10	Ground
11	TXD+ (Transmit Data+)	12	TXD- (Transmit Data-)
13	RXD+ (Receive Data+)	14	RXD- (Receive Data-)

γ **COM4 Figure:**

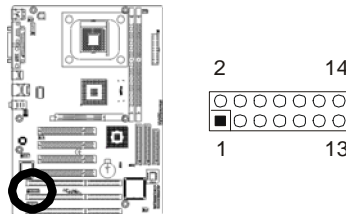

**Note: How to connect RS485 device with COM port ribbon cable?**

Our Industrial Board encloses a COM port ribbon cable for internal connection. RS422/485 device must connect to downside D-Sub with 5-pin cable and signal indication as below.

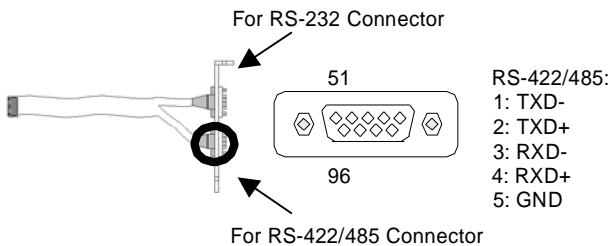

- **Chassis Fan Power Connector: FAN3**

Pin #	Assignment
1	Ground
2	+12V
3	Sense

Figure:

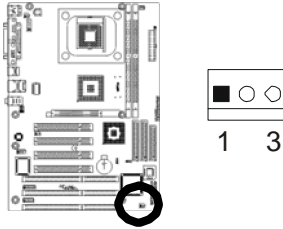

• System Panel Indicate Connector: J1 & J2

Pin #	J1 Assignment	Pin #	J2 Assignment
<b>PWR ON</b>		<b>KEYLOCK</b>	
1	PWRBT-	1	Ground
2	PWRBT+	2	KBLOCK
<b>TB LED</b>		<b>PWR LED</b>	
4	TBLED-	3	PWLED-
5	TBLED+	4	NC
<b>HDD LED</b>		5	PWLED+
6	HDLED-	<b>SPEAKER</b>	
7	HDLED+	7	+5V
<b>IR</b>		8	Ground
9	IRTX	9	NC
10	Ground	10	SPEAKER
11	IRRX	<b>RESET</b>	
12	CIRRX	12	RESET-
13	+5V	13	RESET+

γ Figure:

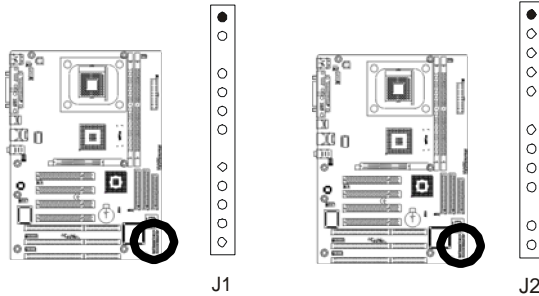

The graphic consists of three overlapping rectangular boxes, each containing the text 'SECTION 3'. The boxes are arranged in a slightly offset, overlapping manner, with the top-left box being the most prominent.

## SECTION 3

### **AWARD BIOS SETUP**

#### **3.1 BIOS Instructions**

Award's ROM BIOS provides a built-in Setup program, which allows user to modify the basic system configuration and hardware parameters. The modified data will be stored in a battery-backed CMOS, so that data will be retained even when the power is turned off. In general, the information saved in the CMOS RAM will stay unchanged unless there is a configuration change in the system, such as hard drive replacement or a device is added.

It is possible for the CMOS battery to fail; this will cause data loss in the CMOS only. If this does happen you will need to reconfigure your BIOS settings.



## 3.2 Main Menu

Once you enter the AwardBIOS™ CMOS Setup Utility, the Main Menu will appear on the screen. The Main Menu allows you to select from several setup functions and two exit choices. Use the arrow keys to select among the items and press <Enter> to accept and enter the sub-menu.

Phoenix - AwardBIOS CMOS Setup Utility	
3/4 Standard CMOS Feature 3/4 Advanced BIOS Feature 3/4 Advanced Chipset Feature 3/4 Integrated Peripherals 3/4 Power Management Setup 3/4 PnP/PCI Configurations 3/4 PC Health Status	3/4 Frequency/Voltage Control Load Fail-Safe Defaults Load Optimized Defaults Set Supervisor Password Set User Password Save & Exit Setup Exit Without Saving
Esc: Quit	↑ ↓ → ←: Select Item
F10: Save & Exit Setup	
Time, Date, Hard Disk Type....	

Note: that a brief description of each highlighted selection appears at the bottom of the screen.

### Setup Items:

The main menu includes the following main setup categories. Recall that some systems may not include all entries.

### Standard CMOS Features:

Use this menu for basic system configuration. See 3.3 for the details.

### Advanced BIOS Features:

Use this menu to set the Advanced Features available on your system. See 3.5 for the details.

### Advanced Chipset Features:

Use this menu to change the values in the chipset registers and optimize your system's performance. See 3.6 for the details.

**Integrated Peripherals:**

Use this menu to specify your settings for integrated peripherals. See section 3.7 for the details.

**Power Management Setup:**

Use this menu to specify your settings for power management. See 3.8 for the details.

**PnP / PCI Configuration:**

This entry appears if your system supports PnP / PCI. See 3.9 for the details.

**PC Health Status:**

Use this menu to show your system temperature, speed and voltage status. See 3.10 for the details.

**Frequency / Voltage Control:**

Use this menu to specify your settings for frequency/voltage control. See 3.11 for the details.

**Load Fail-Safe Defaults:**

Use this menu to load the BIOS default values for the minimal/stable performance for your system to operate. See 3.12 for the details.

**Load Optimized Defaults:**

Use this menu to load the BIOS default values that are factory settings for optimal performance system operations. While Award has designed the custom BIOS to maximize performance, the factory has the right to change these defaults to meet their needs. See 3.13 for the details.

**Supervisor / User Password:**

Use this menu to set User and Supervisor Passwords. See 3.14 for the details.

**Save & Exit Setup:**

Save CMOS value changes to CMOS and exit setup. See 3.15 for the details.

**Exit Without Save:**

Abandon all CMOS value changes and exit setup. See 3.15 for the details.

### 3.3 Standard CMOS Features

The items in Standard CMOS Setup Menu are divided into 10 categories. Each category includes no, one or more than one setup items. Use the arrow keys to highlight the item and then use the <PgUp> or <PgDn> keys to select the value you want in each item.

Phoenix - AwardBIOS CMOS Setup Utility  
Standard CMOS Features

Date: (mm:dd:yy) Time: (hh:mm:ss)	Wed, Aug 5 2003 16:19:20	Item Help ----- -
¾ IDE Primary Master	2557 MB	
¾ IDE Primary Slave	None	Menu Level ¾
¾ IDE Secondary Master	None	
¾ IDE Secondary Slave	None	Change the day, month, year and century
Drive A	1.44M, 3.5 in.	
Drive B	None	
Video	EGA/VGA	
Halt On	All, But Keyboard	
Based Memory	640K	
Extended Memory	130048K	
Total Memory	131072K	
↑↓→←Move Enter: Select +/-/PU/PD: Value F10: Save ESC: Exit F1: General Help F5: Previous Values F6: Fail-safe defaults F7: Optimized Defaults		

**Date:** Options Month/DD/YYYY

Set the system date. Note that the 'Day' automatically changes when you set the date.

**Time:** Options HH : MM : SS

Set the system time.

**IDE Primary Master:** Options are in its sub menu (described in 3.4)

Press <Enter> to enter the sub menu of detailed options.

**IDE Primary Slave:** Options are in its sub menu (described in 3.4)

Press <Enter> to enter the sub menu of detailed options.

**IDE Secondary Master:** Options are in its sub menu (described in 3.4)  
Press <Enter> to enter the sub menu of detailed options.

**IDE Secondary Master:** Options are in its sub menu (described in 3.4)  
Press <Enter> to enter the sub menu of detailed options.

**Drive A/ Drive B:** Options None 360K, 5.25 in/1.2M, 5.25 in/720K, 3.5 in/  
1.44M, 3.5 in/2.88M, 3.5 in  
Select the type of floppy disk drive installed in your system.

**Video:** Options EGA/VGA/CGA 40/CGA 80/MONO  
Select the default video device.

**Halt On:** Options All Errors/No Errors/All, but Keyboard/All, but Diskette/All,  
but Disk/Key  
Select the situation in which you want the BIOS to stop the POST process  
and notify you.

**Base Memory:** Option N/A  
Displays the amount of conventional memory detected during boot up.

**Extended Memory:** Option N/A  
Displays the amount of extended memory detected during boot up

**Total Memory:** Option N/A  
Displays the total memory available in the system

### 3.4 IDE Adapters

The IDE adapters control the hard disk drive. Use a separate sub menu to configure each hard disk drive.

Phoenix - AwardBIOS CMOS Setup Utility

IDE Primary Master

IDE HDD Auto-Detection	Press Enter	Item Help
IDE Primary Master	Auto 2557 MB	
Access Mode	Auto	
Capacity	13579MB	Menu Level ¾¾
Cylinder	26310	To auto-detect the HDD's size, head... on this channel
Head	16	
Precomp	0	
Landing Zone	26309	
Sector	63	
↑↓→←Move Enter: Select +/-/PU/PD: Value F10: Save ESC: Exit F1: General Help F5: Previous Values F6: Fail-safe defaults F7: Optimized Defaults		

#### **IDE HDD Auto-detection:** Options Press Enter

Press Enter to auto-detect the HDD on this channel. If detection is successful, it fills the remaining fields on this menu.

#### **IDE Primary Master:** Options None, Auto and Manual

Selecting "Manual" lets you set the remaining fields on this screen. Selects the type of fixed disk. "User Type" will let you select the number of cylinders, heads, etc. Note: PRECOMP=65535 means NONE !

#### **Access Mode:** Options CHS, LBA, Large and Auto

Choose the access mode for this hard disk.

#### **Capacity:** Options Auto Display your disk drive size.

Disk drive capacity (Approximated). Note that this size is usually slightly greater than the size of a formatted disk given by a disk-checking program.

## Award BIOS Setup

The following options are selectable only if the 'IDE Primary Master' item is set to "Manual"

**Cylinder:** Options Min = 0, Max = 65535

Set the number of cylinders for this hard disk.

**Head:** Options Min = 0, Max = 255

Set the number of read/write heads

**Precomp:** Options Min = 0, Max = 65535

\*\*\*\* **Warning:** Setting a value of 65535 means no hard disk

**Landing zone:** Options Min = 0, Max = 65535

\*\*\*\*

**Sector:** Options Min = 0, Max = 255

Number of sectors per track

### 3.5 Advanced BIOS Features

This section allows you to configure your system for basic operation. You have the opportunity to select the system's default speed, boot-up sequence, keyboard operation, shadowing and security.

Phoenix - AwardBIOS CMOS Setup Utility  
Advanced BIOS Features

Virus Warning	<b>Disabled</b>	Item Help
CPU L1 & L2 Cache Quick	Enabled	
Power On Self Test APIC	Enabled	
Mode	Disabled	Menu Level 3/4
HDD S.M.A.R.T. Capability	Disabled	
3/4 Boot Seq. & Floppy Setup	Press Enter	Allow you to choose the VIRUS
Boot Up NumLock Status	On	warning feature for IDE Hard Disk
Gate A20 Option Typematic	Fast	boot sector protection. If this
Rate Setting	Disabled	function is enabled and someone
X Typematic Rate (Chars/Sec)	6	attempt to write data into this area,
X Typematic Delay (Msec)	250	BIOS will show a warning message
Security Option	Setup	on screen and alarm beep
OS Select For DRAM > 64MB	Non-OS2	
↑↓→←Move Enter: Select +/-/PU/PD: Value F10: Save ESC: Exit F1: General Help F5: Previous Values F6: Fail-safe defaults F7: Optimized Defaults		

#### Virus Warning:

Allow you to choose the VIRUS Warning feature for IDE Hard Disk boot sector protection. If this function is enabled and someone attempt to write data into this area, BIOS will show a warning message on screen and alarm beep.

Enabled---Activates automatically when the system boots up causing a warning message to appear when anything attempts to access the boot sector or hard disk partition table.

Disabled---No warning message will appear when anything attempts to access the boot sector or hard disk partition table.

#### CPU L1 & L2 Cache:

These two categories speed up memory access. However, it depends on CPU/chipset design.

Enabled---Enable cache

Disabled---Disable cache

**Quick Power On Self Test:**

This category speeds up Power On Self Test (POST) after you power up the computer. If it is set to Enable, BIOS will shorten or skip some check items during POST.

- Enabled---Enable quick POST
- Disabled--- Normal POST

**APIC Mode:**

This item allows you to enable/disable APIC Mode.

The choice: Enabled, Disabled.

**HDD S.M.A.R.T Capability:**

Enabled SMART hard driver functions for compatible. The default is disabled.

The choice: Enabled, Disabled.

**Boot Seq. & Floppy Setup:**

Phoenix - AwardBIOS CMOS Setup Utility

Boot Seq. & Floppy Setup

First Boot Device	<b>Floppy</b>	Item Help
Second Boot Device	HDD-0	
Third Boot Device	SCSI	
Boot Other Device	Enabled	Menu Level 3/4
Swap Floppy Drive	Disabled	Select your Boot Device Priority
Boot Up Floppy Seek	Disabled	
Report NO FDD For Win 95	No	
↑↓→←Move Enter: Select +/-/PU/PD: Value F10: Save ESC: Exit F1: General Help F5: Previous Values F6: Fail-safe defaults F7: Optimized Defaults		

**First/Second/Third Boot Device:**

The BIOS attempts to load the operating system from the devices in the sequence selected in these items.

The Choice: Floppy, LS/ZIP, HDD, SCSI, CDROM, LAN and Disabled.

**Boot Other Device:**

When enabled, the system searches all other possible locations for an operating system if it fails to find one in the devices specified under the first, second, and third boot devices.

The Choice: Enabled, Disabled



**Swap Floppy Drive:**

If the system has two floppy drives, you can swap the logical drive name assignments.

The choice: Enabled, Disabled.

**Boot Up Floppy Seek:**

Seeks disk drives during boot up. Disabling speeds boot up.

The choice: Enabled, Disabled.

**Report No FDD For Win 95:**

Whether report no FDD for Win 95 or not.

The choice: Yes, No.

**Boot Up NumLock Status:**

Select power on state for NumLock.

The choice: Off, On

**Gate A20 Option:**

Select if chipset or keyboard controller should control GateA20.

Normal---A pin in the keyboard controller controls GateA20

Fast---Lets chipset control GateA20

**Typematic Rate Setting:**

Keystrokes repeat at a rate determined by the keyboard controller. When enabled, the typematic rate and typematic delay can be selected.

The choice: Enabled, Disabled.

**Typematic Rate (Chars/Sec):**

Sets the number of times a second to repeat a keystroke when you hold the key down.

The choice: 6, 8, 10, 12, 15, 20, 24 and 30.

**Typematic Delay (Msec):**

Sets the delay time after the key is held down before it begins to repeat the keystroke.

The choice: 250, 500, 750 and 1000.

**Security Option:**

Select whether the password is required every time the system boots or only when you enter setup.

System---The system will not boot and access to Setup will be denied if the correct password is not entered at the prompt.

Setup---The system will boot, but access to Setup will be denied if the correct password is not entered at the prompt.

Note: To disable security, select PASSWORD SETTING at Main Menu and then you will be asked to enter password. Do not type anything and just press <Enter>, it will disable security. Once the security is disabled, the system will boot and you can enter Setup freely.

**OS Select For DRAM > 64MB:**

Select the operating system that is running with greater than 64MB of RAM on the system.

The choice: Non-OS2, OS2.

### 3.6 Advanced Chipset Features

This section allows you to configure the system based on the specific features of the installed chipset. This chipset manages bus speeds and access to system memory resources, such as DRAM and the external cache. It also coordinates communications between the conventional ISA bus and the PCI bus. It must be stated that these items should never need to be altered. The default settings have been chosen because they provide the best operating conditions for your system. The only time you might consider making any changes would be if you discovered that data was being lost while using your system.

#### Phoenix - AwardBIOS CMOS Setup Utility

##### Advanced Chipset Features

	By SPD	Item Help
DRAM Timing Selectable	By SPD	
X CAS Latency Time	2.5	
X Active To Precharge Delay	6	
X DRAM RAS# To CAS# Delay	3	Menu Level ¾
X DRAM RAS# Precharge	3	
System BIOS Cacheable Video	Enabled	
BIOS Cacheable Delayed	Disabled	
Transaction Command Per Clock	Enabled	
Fast CS#	Auto Auto	
Delay Prior To Thermal	16Min.	
AGP Aperture Size (MB)	64	
** On-Chip VGA Setting **		
On-Chip VGA	Enabled	
On-Chip Frame Buffer Size	8MB	
Boot Display	Auto	
TV Format	Auto	

↑↓→←Move Enter: Select +/-/PU/PD: Value F10: Save ESC: Exit F1: General Help  
F5: Previous Values F6: Fail-safe defaults F7: Optimized Defaults

#### DRAM Timing Selectable:

Select the operating system that is selecting DRAM timing, so select SPD for setting SDRAM timing by SPD.

The choice: Manual, By SPD and Turbo.

**CAS Latency Time:**

When synchronous DRAM is installed, the number of clock cycles of CAS latency depends on the DRAM timing.

The choice: 1.5, 2, and 2.5.

**Active To Precharge Delay:**

Select the operating system that is active to precharge delay.

The choice: 5, 6 and 7.

**DRAM RAS# To CAS# Delay:**

This field let's you insert a timing delay between the CAS and RAS strobe signals, used when DRAM is written to, read from, or refreshed. Fast gives faster performance; and Slow gives more stable performance. This field applies only when synchronous DRAM is installed in the system.

The choice: 2, 3.

**DRAM RAS# Precharge:**

If an insufficient number of cycles are allowed for the RAS to accumulate its charge before DRAM refresh, the refresh may be incomplete and the DRAM may fail to retain data. Fast gives faster performance; and Slow gives more stable performance. This field applies only when synchronous DRAM is installed in the system.

The choice: 2, 3.

**System BIOS Cacheable:**

Selecting "Enabled" allows caching of the system BIOS ROM at F0000h-FFFFFh, resulting in better system performance. However, if any program writes to this memory area, a system error may result.

The choice: Enabled, Disabled.

**Video BIOS Cacheable:**

Select "Enabled" allows caching of the video BIOS, resulting in better system performance. However, if any program writes to this memory area, a system error may result.

The choice: Enabled, Disabled.

**Delayed Transaction:**

The chipset has an embedded 32-bit posted write buffer to support delay transactions cycles. Select "Enabled" to support compliance with PCI specification version 2.2.

The choice: Enabled, Disabled.

**Command Per Clock:**

Select this item allows the command per clock for system.

The choice: Auto, Enabled, Disabled.

**Fast CS#:**

Select this item allows the Fast CS# function.

The choice: Auto, Enabled and Disabled.

**Delay Prior To Thermal:**

Select this item allows the delay prior to thermal time.

The choice: 4, 8, 16 and 32 Min.

**AGP Aperture Size (MB):**

This field determines the effective size of the Graphic Aperture used for a particular GMCH configuration. It can be updated by the GMCH-specific BIOS configuration sequence before the PCI standard bus enumeration sequence takes place. If it is not updated then a default value will select an aperture of maximum size.

The choice: 32, 64, 128 and 256.

**On-Chip VGA**

Select this item allows you to control the on-chip VGA.

The choice: Enabled, Disabled.

**On-Chip Frame Buffer Size:**

Select this item allows you to control the on-chip frame buffer size.

The choice: 1MB, 8MB.

**Boot Display:**

Select this item allows you to set the boot display device.

The choice: Auto, CRT, TV and EFP.

**TV Format:**

Select this item allows you to set the TV format.

### 3.7 Integrated Peripherals

Phoenix - AwardBIOS CMOS Setup Utility

Integrated Peripherals

¾ Onboard IDE Device Setup <b>Press Enter</b> ¾ Onboard PCI Device Setup      Press Enter ¾ Onboard I/O Chip Setup        Press Enter IDE DMA transfer access        Enabled Init Display First                Onboard Intel LAN Boot ROM               Disabled	Item Help <hr/> Menu Level    ¾
↑↓←→Move    Enter: Select    +/-/PU/PD: Value    F10: Save    ESC: Exit    F1: General Help F5: Previous Values    F6: Fail-safe defaults    F7: Optimized Defaults	

#### Onboard IDE Device Setup:

Phoenix - AwardBIOS CMOS Setup Utility

Onboard IDE Device Setup

On-Chip Primary PCI IDE <b>Enabled</b> IDE Primary Master PIO        Auto Auto IDE Primary Slave PIO         Auto Auto IDE Primary Master UDMA       Enabled IDE Primary Slave UDMA On- Chip Secondary PCI IDE IDE    Auto Auto Secondary Master PIO IDE      Enabled Secondary Slave PIO IDE Secondary Master UDMA IDE Secondary Slave UDMA IDE HDD Block Mode	Item Help <hr/> Menu Level    ¾
↑↓←→Move    Enter: Select    +/-/PU/PD: Value    F10: Save    ESC: Exit    F1: General Help F5: Previous Values    F6: Fail-safe defaults    F7: Optimized Defaults	

#### On-Chip Primary/Secondary PCI IDE:

The integrated peripheral controller contains an IDE interface with support for two IDE channels. Select "Enabled" to activate each channel separately.

The choice: Enabled, Disabled.

**IDE Primary/Secondary Master/Slave PIO:**

The four IDE PIO (Programmed Input/Output) fields let you set a PIO mode (0-4) for each of the four IDE devices that the onboard IDE interface supports. Modes 0 through 4 provide successively increased performance. In Auto mode, the system automatically determines the best mode for each device.

The choice: Auto, Mode 0, Mode 1, Mode 2, Mode 3 and Mode 4.

**IDE Primary/Secondary Master/Slave UDMA:**

Ultra DMA/33 implementation is possible only if your IDE hard drive supports it and the operating environment includes a DMA driver (Windows 95 OSR2 or a third-party IDE bus master driver). If your hard drive and your system software both support Ultra DMA/33, select "Auto" to enable BIOS support.

The choice: Auto, Disabled.

**IDE HDD Block Mode:**

Block mode is also called block transfer, multiple commands, or multiple sector read/write. If your IDE hard drive supports block mode (most new drives do), select Enabled for automatic detection of the optimal number of block read/writes per sector the drive can support.

The choice: Enabled, Disabled

**Onboard PCI Device Setup:**

Phoenix - AwardBIOS CMOS Setup Utility

## Onboard PCI Device Setup

USB Controller	Enabled	Item Help
USB 2.0 Controller USB	Enabled	
Keyboard Support USB	Auto	
Mouse Support AC97	Disabled	Menu Level 3/4
Audio	Auto	
Onboard LAN Controller	Enabled	
↑↓→←Move Enter: Select +/-PU/PD: Value F10: Save ESC: Exit F1: General Help F5: Previous Values F6: Fail-safe defaults F7: Optimized Defaults		

**USB/USB 2.0 Controller:**

Select "Enabled" if your system contains a USB/USB2.0 controller and you have USB peripherals.

The choice: Enabled, Disabled.

**USB Keyboard Support:**

Select "Enabled" if your system contains a Universal Serial Bus (USB) controller and you have a USB keyboard.

The choice: Enabled, Disabled and Auto.

**USB Mouse Support:**

Select "Enabled" if your system contains a Universal Serial Bus (USB) controller and you have a USB mouse.

The choice: Enabled, Disabled.

**AC97 Audio:**

This item allows you to auto or disable to support AC97 Audio.

The choice: Auto, Disabled.

**Onboard LAN Controller:**

Select "Enabled" to Enables the onboard LAN feature.

The choice: Enabled, Disabled.

**Onboard I/O Chip Setup:**

Phoenix - AwardBIOS CMOS Setup Utility

Onboard I/O Chip Setup

Onboard FDC Controller	<b>Enabled</b>	Item Help
Onboard Serial Port 1	3F8/IRQ4	
Onboard Serial Port 2	2F8/IRQ3	<hr/> Menu Level ¼ If your IDE hard drive supports block mode select Enabled for automatic detection of the optimal number of block read/write per sector the drive can support
UART Mode Select	Normal	
X Rx/D, Tx/D Active	Hi, Lo	
X IR Transmission Delay	Enabled	
X UR2 Duplex Mode	Half	
X Use IR Pins	IR-Rx2Tx2	
Onboard Parallel Port	378/IRQ7	
Parallel Port Mode	SPP	
X EPP Mode Select	EPP1.7	
X ECP Mode Use DMA	3	
↑↓→←Move Enter: Select +/-/PU/PD: Value F10: Save ESC: Exit F1: General Help F5: Previous Values F6: Fail-safe defaults F7: Optimized Defaults		

**Onboard FDC Controller:**

Select "Enabled" if your system has a floppy disk controller (FDC) installed on the system board and you wish to use it. If you install and-in FDC or the system has no floppy drive, select Disabled in this field.

The choice: Enabled, Disabled.



**Onboard Serial Port 1/Port 2:**

Select an address and corresponding interrupt for the first and second serial ports.

The choice: 3F8/IRQ4, 2E8/IRQ3, 3E8/IRQ4, 2F8/IRQ3, Disabled and Auto.

**UART Mode Select:**

This item allows you to select UART mode.

The choice: IrDA, ASKIR and Normal.

**RxD, TxD Active:**

This item allows you to determine the active of RxD, TxD.

The Choice: "Hi, Hi", "Lo, Lo", "Lo, Hi" and "Hi, Lo".

**IR Transmission Delay:**

This item allows you to enable/disable IR transmission delay.

The choice: Enabled, Disabled.

**UR2 Duplex Mode:**

This item allows you to select the IR half/full duplex function.

The choice: Half, Full.

**Use IR Pins:**

This item allows you to select IR transmission routes, one is RxD2m, TxD2 (COM Port) and the other is IR-Rx2Tx2.

The choice: IR-Rx2Tx2, RxD2 and TxD2.

**Onboard Parallel Port:**

This item allows you to determine access onboard parallel port controller with which I/O address.

The choice: 3BC/IRQ7, 378/IRQ7, 278/IRQ5 and Disabled.

**Parallel Port Mode:**

Select an operating mode for the onboard parallel (printer) port. Select Normal, Compatible, or SPP unless you are certain your hardware and software both support one of the other available modes.

The choice: SPP, EPP, ECP and ECP+EPP, Normal.

**EPP Mode Select:**

Select EPP port type 1.7 or 1.9.

The choice: EPP1.7, 1.9.

**ECP Mode Use DMA:**

Select a DMA channel for the parallel port for use during ECP mode.

The choice: 3, 1.

**IDE DMA transfer access:**

This item allows you to enable or disable the IDE DMA transfer access.

The choice: Enabled, Disabled.

**Init Display First:**

This item allows you to decide to active whether PCI Slot or on-chip VGA first.

The choice: PCI Slot, Onboard.

**Intel Lan Boot ROM:**

This item allows you to decide whether to invoke the boot ROM of the onboard LAN chip.

The choice: Enabled, Disabled.

### 3.8 Power Management Setup

The Power Management Setup allows you to configure you system to most effectively save energy while operating in a manner consistent with your own style of computer use.

Phoenix - AwardBIOS CMOS Setup Utility

Power Management Setup

		Item Help
POWER ON Function	<b>Hot KEY</b>	
X KB Power ON Password	Enter	
Hot Key Power ON	Ctrl+F1	
PWRON After PWR-Fail	Off	Menu Level 3/4
Power Management	User Define	
Video Off Method	DPMS	
Video Off In Suspend	Yes	
MODEM Use IRQ	3	
Suspend Mode	Disabled	
HDD Power Down	Disabled	
Soft-Off by PWR-BTTN CPU	Instant-Off	
THER-Throttling Wake-Up	50.0%	
by PCI card Power On By	Disabled	
Ring or WOL Resume by	Enabled	
Alarm	Disabled	
X Date (of Month) Alarm	0	
X Time (hh:mm:ss) Alarm	0 : 0 : 0	
<b>** Reload Global Timer Events **</b>		
Primary IDE 0	Disabled	
Primary IDE 1	Disabled	
Secondary IDE 0	Disabled	
Secondary IDE 1	Disabled	
FDD, COM, LPT Port	Disabled	
PCI PIRQ [A-D]#	Disabled	
↑↓→←Move Enter: Select +/-/PU/PD: Value F10: Save ESC: Exit F1: General Help F5: Previous Values F6: Fail-safe defaults F7: Optimized Defaults		

#### Power On Function:

You can use this item to select operating Power On the system.

The choice: Password, Hot KET, Any Key, Button and Keyboard 98.

#### KB Power ON Password:

You can press Enter to set the password to limit operating KB Power On system.

**Hot Key Power ON:**

You can use this item to select operating Hot Key to Power On system.  
The choice: Ctrl+F1 ~ Ctrl+F12

**PWRON After PWR-Fail:**

This item allows you to select if you want to power on the system after power failure.  
The choice: Off, Former-Sts.

**Power Management:**

This category allows you to select the type (or degree) of power saving and is directly related to the following modes:

**Min. Power Saving:**

Minimum power management. Doze Mode = 1 hr. Standby Mode = 1 hr., Suspend Mode = 1 hr., and HDD Power Down = 15 min.

**Max. Power Saving:**

Maximum power management -- **ONLY AVAILABLE FOR SL CPU's.**  
Doze Mode = 1 min., Standby Mode = 1 min., Suspend Mode = 1 min., and HDD Power Down = 1 min.

**User Defined:**

Allow you to set each mode individually. When not disabled, each of the ranges is from 1 min. to 1 hr. except for HDD Power Down, which ranges from 1 min. to 15 min. and disable.

**Video Off Method:**

This determines the manner in which the monitor is blanked.

**V/H SYNC+Blank:**

This selection will cause the system to turn off the vertical and horizontal synchronization ports and write blanks to the video buffer.

**Blank Screen:**

This option only writes blanks to the video buffer.

**DPMS:**

Initial display power management signaling.

**Video Off In Suspend:**

This determines the manner in which the monitor is blanked.

The choice: Yes, No.

**MODEM Use IRQ:**

This determines the IRQ in which the MODEM can use.

The choice: 3, 4, 5, 7, 9, 10, 11 and NA.

**Suspend Mode:**

When "Enabled" and after the set time of system inactivity. All devices except the CPU will be shut off.

The choice: Disabled, 1, 2, 4, 8, 12, 20, 30, 40 Min and 1Hour.

**HDD Power Down:**

When "Enabled" and after the set time of system inactivity, the hard disk drive will be powered down while all other devices remain active.

The choice: Disabled, 1 ~ 15 Min.

**Soft-Off by PWR-BTTN:**

Pressing the power button for more than 4 seconds forces the system to enter the Soft-Off state when the system has "hung."

The choice: Delay 4 Sec, Instant-Off.

**CPU THER-Throttling:**

Select the CPU THRM-Throttling rate.

The choice: 12.5%, 25.0%, 37.5%, 50.0%, 62.5%, 75.0% and 87.5%.

**Wake-Up by PCI Card:**

An input signal from PME on the PCI card awakens the system from a soft off state.

The choice: Enabled, Disabled.

**Power On by Ring or WOL:**

An input signal on the serial Ring Indicator (RI) line (in other words, an incoming call on the modem) awakens the system from a soft off state.

The choice: Enabled, Disabled.

**Resume by Alarm:**

When “Enabled”, you can set the date and time at which the RTC (real-time clock) alarm awakens the system from Suspend mode.

The choice: Enabled, Disabled.

**Reload Global Timer Events:**

The events are I/O events whose occurrence can prevent the system from entering a power saving mode or can awaken the system from such a mode. In effect, the system remains alert for anything, which occurs to a device, which is configured as Enabled, even when the system is in a power down mode.

Primary IDE 0

Primary IDE 1

Secondary IDE 0

Secondary IDE 1

FDD, COM, LPT Port

PCI PIRQ [A-D] #

### 3.9 PnP/PCI Configurations

This section describes configuring the PCI bus system. PCI, or **Personal Computer Interconnect**, is a system, which allows I/O devices to operate at speeds nearing the speed the CPU itself uses when communicating with its own special components. This section covers some very technical items and it is strongly recommended that only experienced users should make any changes to the default settings.

Phoenix - AwardBIOS CMOS Setup Utility  
PnP/PCI Configurations

Resources Controlled By	<b>Auto (ESCD)</b>	Item Help
X IRQ Resources	Press Enter	
X DMA Resources	Press Enter	
PCI/VGA Palette Snoop	Disabled	Menu Level 3/4
↑↓→←Move Enter: Select +/-PU/PD: Value F10: Save ESC: Exit F1: General Help F5: Previous Values F6: Fail-safe defaults F7: Optimized Defaults		

#### Resource controlled by:

The Award Plug and Play BIOS has the capacity to automatically configure all of the boot and Plug and Play compatible devices. However, this capability means absolutely nothing unless you are using a Plug and Play operating system such as Windows®95. If you set this field to "Manual" choose specific resources by going into each of the sub menu that follows this field (a sub menu is preceded by a "3/4").

The choice: Auto (ESCD), Manual.

#### IRQ/DMA Resources:

When resources are controlled manually, assign each system interrupt a type, depending on the type of device using the interrupt.

#### PCI/VGA Palette Snoop:

Leave this field at "Disabled".

The choice: Enabled, Disabled.

### 3.10 PC Health Status

Phoenix - AwardBIOS CMOS Setup Utility

#### PC Health Status

Show PC Health in Post	<b>Enabled</b>	Item Help
Current CPU Temp.	40°C / 104°F	
Current System Temp.	24°C / 75°F	
Current Chassis Fan Speed	3283RPM	Menu Level ¾
Current CPU Fan Speed	5152RPM	
Current Power Fan Speed	4182RPM	
Vagp (V)	1.52V	
Vcore (V)	1.71V	
Vdimm (V)	2.48V	
+ 5 V	4.81V	
+12 V	11.73V	
ACPI Shutdown Temperature	Disabled	
↑↓→←Move Enter: Select +/-PU/PD: Value F10: Save ESC: Exit F1: General Help F5: Previous Values F6: Fail-safe defaults F7: Optimized Defaults		

#### Show PC Health in Post:

When this function is enabled the PC health information is displayed during the POST(Power On SelfTest).

The choice: Enabled, Disabled.

#### Current CPU Temp:

Show you the current CPU temperature.

#### Current System Temp:

Show you the current system temperature.

#### Current Chassis Fan Speed:

Show you the current CPU fan operating speed.

#### Current CPU Fan Speed:

Show you the current CPU fan operating speed.

#### Current Power Fan Speed:

Show you the current Power fan operating speed.



**Vagp (V)**

The voltage level of Power supplied to AGP card.

**Vcore (V)**

The voltage level of CPU (Vcore).

**Vdimm (V)**

The voltage level of the DRAM.

**+5V/+12V:**

Show you the voltage of +5V/+12V.

**APCI Shutdown Temperature:**

This item allows you to set up the CPU shutdown Temperature. This item is only effective under Windows® 98 ACPI mode.

The choice: Disabled, 60°C / 140°F, 70°C / 158, 75°C / 167°F, 80°C / 176°F, 85°C / 185°F, 90°C / 194°F and 95°C / 203°F.

### 3.11 Frequency/Voltage Control

Phoenix - AwardBIOS CMOS Setup Utility

Frequency/Voltage Control

CPU Clock Ratio Watch	19X	Item Help
Dog Function CPU FSB / SPEED Memory	Disabled	
Frequency Next boot	100MHz/2.40GHz	
AGP/PCI is AGP / PCI	Auto=>DDR266	Menu Level 3/4
Clock AGP/PCI subtle tuning	66/33MHz	
Clock Generation for EMI	Auto	
	66MHz	
	Press Enter	
↑↓→←Move Enter: Select +/-PU/PD: Value F10: Save ESC: Exit F1: General Help F5: Previous Values F6: Fail-safe defaults F7: Optimized Defaults		

#### CPU Clock Ratio:

This item allows you to set up the CPU clock ratio, but this function depends on different CPU performance. It is only effective for those clock ratio haven't been locked.

#### Watching Dog Function

If you select enabled and over clock fail before POST code 26h, the system will reset automatically by default configuration.

The choice: Enabled, Disabled.

#### CPU FSB / SPEED:

This item allows you to enable or disable the CPU FSB speed.

The choice: 90MHz~ 200MHz.

#### Memory Frequency:

Enables you to select a ratio of the Double Data Rate Synchronous DRAM to match the installed DRAM frequency 200/266/333MHz.

#### AGP/PCI Clock:

Enables you to select host clock to work concurrently with the PCI bus or the AGP bus.

#### AGP/PCI subtle tuning:

Enables you to select AGP/PCI frequency.

**Clock Generation for EMI:**

## Clock Generation for EMI

Auto Detect PCI Clk <b>Enabled</b>	Item Help
Spread Spectrum Modulated Disabled	_____
	Menu Level 3/4
↑↓→←Move Enter: Select +/-PU/PD: Value F10: Save ESC: Exit F1: General Help F5: Previous Values F6: Fail-safe defaults F7: Optimized Defaults	

**Auto Detect PCI Clk:**

When enabled the mainboard automatically disables the clock source for a PCI slot which does not have a module in it, reducing EMI (ElectroMagnetic Interference).

The choice: Enabled, Disabled.

**Spread Spectrum Modulated:**

If you enable spread spectrum, it can significantly reduce the EMI (ElectroMagnetic Interference) generated by the system.

The choice: +/- 0.35%, +/- 0.50%, +/- 0.75%, +/- 1.0%, Disabled.

### 3.12 Load Fail-Safe Defaults

When you press <Enter> on this item you get a confirmation dialog box with a message similar to:

Load Fail-Safe Defaults (Y/N)? **N**

Pressing 'Y' loads the BIOS default values for the most stable, minimal-performance system operations.

### 3.13 Load Optimized Defaults

When you press <Enter> on this item you get a confirmation dialog box with a message similar to:

Load Optimized Defaults (Y/N)? **N**

Pressing 'Y' loads the default values that are factory settings for optimal performance system operations.

### 3.14 Supervisor/User Password Setting

You can set either supervisor or user password, or both of them. The differences between are:

**Set Supervisor Password:** can enter and change the options of the setup menus.

**Set User Password:** just can only enter but do not have the right to change the options of the setup menus. When you select this function, the following message will appear at the center of the screen to assist you in creating a password.

#### ENTER PASSWORD:

Type the password, up to eight characters in length, and press <Enter>. The password typed now will clear any previously entered password from CMOS memory. You will be asked to confirm the password. Type the password again and press <Enter>. You may also press <Esc> to abort the selection and not enter a password.

To disable a password, just press <Enter> when you are prompted to enter the password. A message will confirm the password will be disabled. Once the password is disabled, the system will boot and you can enter Setup freely.

#### PASSWORD DISABLED.

When a password has been enabled, you will be prompted to enter it every time you try to enter Setup. This prevents an unauthorized person from changing any part of your system configuration.

Additionally, when a password is enabled, you can also require the BIOS to request a password every time your system is rebooted. This would prevent unauthorized use of your computer.

You determine when the password is required within the BIOS Features Setup Menu and its Security option (see Section 3). If the Security option is set to "System", the password will be required both at boot and at entry to Setup. If set to "Setup", prompting only occurs when trying to enter Setup.

### 3.15 Exit Selecting

#### Save & Exit Setup

Pressing <Enter> on this item asks for confirmation:

**Save to CMOS and EXIT (Y/N)?**  Y

Pressing “Y” stores the selections made in the menus in CMOS – a special section of memory that stays on after you turn your system off. The next time you boot your computer, the BIOS configures your system according to the Setup selections stored in CMOS. After saving the values the system is restarted again.

#### Exit Without Saving

Pressing <Enter> on this item asks for confirmation:

**Quit without saving (Y/N)?**  Y

This allows you to exit Setup without storing in CMOS any change. The previous selections remain in effect. This exits the Setup utility and restarts your computer.

### 3.16 Contact Information

Thank you for purchasing from Global American Inc. We will stand by our slogan,

*Integration with Integrity.*

Please let us know how your product is performing and if we can help you with any future product lines.



17 Hampshire Drive  
Hudson, NH 03051

Telephone: (800)833-8999

FAX: (603)886-4545

Website: <http://www.globalamericaninc.com>

Email: [salesinfo@globalamericaninc.com](mailto:salesinfo@globalamericaninc.com) (Sales)

[support@globalamericaninc.com](mailto:support@globalamericaninc.com) (Tech Support)