

2807604

**Mini-ITX Motherboard
User's Manual
Edition 1.0**

2004/6/23

Copyright

Copyright© 2003 -2004. All rights reserved. This document is copyrighted and all rights are reserved. The information in this document is subject to change without prior notice to make improvements to the products.

This document contains proprietary information and protected by copyright. No part of this document may be reproduced, copied, or translated in any form or any means without prior written permission of the manufacturer.

All trademarks and/or registered trademarks contains in this document are property of their respective owners.

Disclaimer

The company shall not be liable for any incidental or consequential damages resulting from the performance or use of this product.

The company does not issue a warranty of any kind, express or implied, including without limitation implied warranties of merchantability or fitness for a particular purpose. The company has the right to revise the manual or include changes in the specifications of the product described within it at any time without notice and without obligation to notify any person of such revision or changes.

Trademark

All trademarks are the property of their respective holders.

Packing List:

Hardware:

2807604 Mini-ITX Motherboard X 1

Cable:

34 -pin floppy cable..... X 1



40 -pin IDE ATA100 cable X 1



4 -pin power cable X 1



AD_LAN RJ45 module with bracket..... X 1



10 -pin to 10 -pin **AD_LAN** connecting cable X 1



Printed Matter and Software

CD Driver X 1

User's Manual..... X 1

Table of Content

Chapter 1 Introduction	7
1.1 Product Overview	7
1.2 Product Specification.....	8
1.3 Component Placement.....	11
Chapter 2 Hardware Setup.....	13
2.1 Connectors and Jumpers	13
2.1.1 Connector Location	13
2.1.1 Jumper Location	14
2.1.2 Connector Reference	15
2.2 CPU and DRAM setting	16
2.3 CMOS setting.....	17
2.4 Embedded Solid State Disk.....	18
2.4.1 DiskOnModule (DOM)	18
2.4.2 Compact Flash Socket	19
2.5 Power Configuration.....	20
2.6 Display Interface	22
2.61 Standard CRT VGA interface.....	22
2.62 Digital LCD VGA interface	22
2.7 Ethernet Interface.....	27
2.8 Audio Interface	29
2.9 Serial Port Setup	31
2.10 GPIO Interface	33
2.11 Switches and Indicators	35
Chapter 3 BIOS setup.....	37
Chapter 4 Driver Installation	39

Appendix. A I/O Port Pin Assignment	41
A.1 IDE Port	41
A.2 Floppy Port.....	43
A.3 Parallel Port	44
A.4 Serial Port	44
A.5 IrDA port.....	45
A.6 VGA Port.....	45
A.7 LAN Port	45
Appendix B Flash the BIOS	47
B.1 BIOS Auto Flash Tool	47
B.2 Flash Method.....	47

(This page is left for blank)

(This page is left for blank)

Chapter 1 Introduction

1.1 Product Overview

2807604 is an all-in-one industrial compact NS GX1 Embedded motherboard based on Mini-ITX form factor at 170 x 170 mm of dimension. Based on NS GXM processor and NS 5530 chipset, **2807604** offers the compact, embedded, value and fan free solution with NS Geode GX1 CPU with 300MHz, 384MB SDRAM, integrated Graphics, AC'97 Audio, dual 10/100Mbps LAN controllers, USB, GPIO and embedded flash disk interfaces.

Low Power/Embedded computing platform

2807604 is based on NS Geode x86-compliant architecture, it provide the ultra low power consumption for easy to build a fan free, low cost embedded system.

Onboard 32/64/128MB SDRAM

The onboard embedded SDRAM let **2807604** be the low profile solution with space-/slot-saving for system configuration. It also makes **2807604** be the rugged and vibration-proof solution with embedded CPU and memory.

LVDS/TTL Flat Panel Interface

The integrated LVDS/TTL interface offers the digital video output for flat panel with built-in VGA controller and 4 MB video memory. The board can support LCD for 18-bit output.

All-In-One Integrated Solution

2807604 is an all-in-one computing platform with integrated video, audio, LAN, PC/104, Compact Flash and RS422/485 interfaces.

Embedded OS Support

The NS Geode platform supports the popular embedded OS including Microsoft WinCE, embedded Linux, QNX, VxWorks and other popular embedded OS for the industrial embedded applications.

1.2 Product Specification

General Specification

Form Factor	Mini-ITX with 170mm x 170mm (W x D)
CPU	Onboard embedded NS GX1 300 MHz CPU Ultra low power consumption for fan free application
Memory	Onboard 32/64/128MBytes SDRAM One 168-pin DIMM supports up to 256MB SDRAM Total system memory capacity up to 384MB SDRAM
Chipset	NS Geode CS5530
BIOS	Phoenix-Award 2Mb PnP flash BIOS
Green Function	Power saving mode supported in BIOS with DOZE, STANDBY and SUSPEND modes. ACPI version 1.0 and APM version 1.2 compliant
Watchdog Timer	Generates NMI or system reset watchdog timer
Real Time Clock	Chipset built-in RTC with onboard lithium battery
Enhanced IDE	Two UltraDMA/66 IDE port support up to 4 ATAPI devices One 40-pin IDE1 and one 44-pin IDE2 connector
Expansion Slot	One ISA slot

Multi-I/O Port

Chipset	Winbond W83977F-A super-I/O controller
Serial Port	One RS-232 and one jumper selectable RS-232/422/485 serial ports. Both with 16C550 compatible UART and 16 bytes FIFO.
USB Port	Two USB ports with USB version 1.1 compliant
Parallel Port	One bi-direction parallel port with SPP/ECP/EPP mode
FDD	One FDD port supports up to two floppy devices
IrDA Port	One IrDA compliant Infrared interface supports SIR
K/B & Mouse	PS/2 keyboard and mouse ports
GPIO	16-bit GPIO with 8-bit digital input and 8-bit digital output

Solid State Disk Interface

Flash Type	Compact Flash Type I/II socket
Capacity	Up to 1GB of capacity

VGA Display Interface

Chipset	NS Geode CS5530 built-in VGA controller with 2D engine
Video Memory	Up to 4MBytes of video memory shared with system
Display Type	18-bit LVDS/TTL TFT LCD and CRT display LVDS interface with 20 to 85 MHz of scalable bandwidth
Connector	External DB15 female connector on bracket for CRT Onboard 2 x 20pin header for TTL TFT LCD HIROSE DF13-20DP-1.25V 20-pin connector for LVDS TFT LCD

Ethernet Interface

Chipset	Dual PCI-based Realtek RTL8100B controller
Type	10Base-T / 100Base-TX, auto-switching Fast Ethernet Full duplex, IEEE802.3U compliant
Connector	One External RJ45 with LED on bracket One internal pin header with RJ45 add-on module

Audio Interface

Chipset	NS Geode CS5530 built-in Realtek ALC201A with AC'97 3D audio codec
Interface	Line-in, Line-out, CD-in, MIC-in
Connector	10-pin header for line-in, line-out and MIC-in 4-pin header for CD-in Audio jack on real I/O panel for amplified speaker

Power and Environment

Power Req.	Support single +12V DC power input One external Mini-DIN power connector One internal 4-pin power connector
Input Voltage Range	11V ~ 13V
Input Current	12V/2A 24W (without panel, HDD, and CDROM connected)
Dimension	170 (L) x 170 (H) mm
Temperature	Operating within 0 ~ 60°C (32 ~ 140°F) Storage within -20 ~ 85°C (-4 ~ 185°F)

Ordering Code

2807604	Mini-ITX Embedded GX1 CPU with NS GX1 300 MHz CPU, LVDS/TTL TFT LCD / CRT SVGA, LAN, Audio, Compact Flash and PC/104 Interface, onboard 128MB SDRAM
----------------	---

1.3 Component Placement

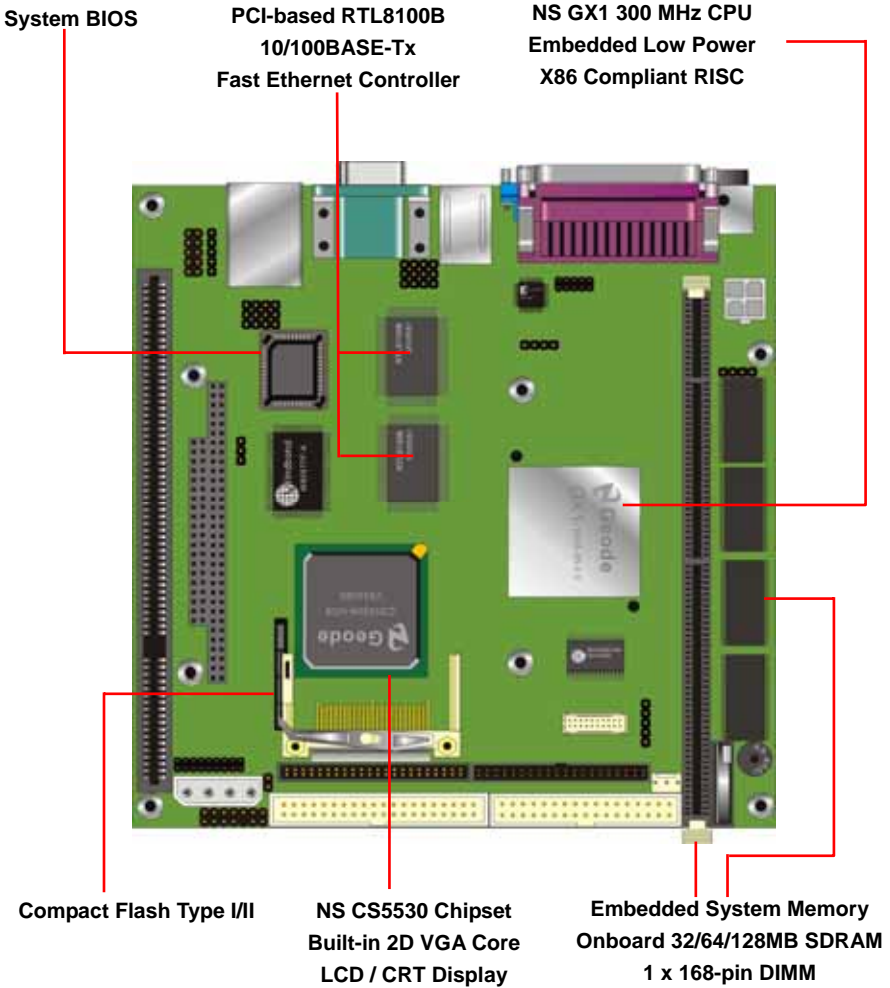

(This page is left for blank)

Chapter 2 Hardware Setup

This chapter will lead you to setup our board properly, please follow the instructions below before you use this board.

2.1 Connectors and Jumpers

2.1.1 Connector Location

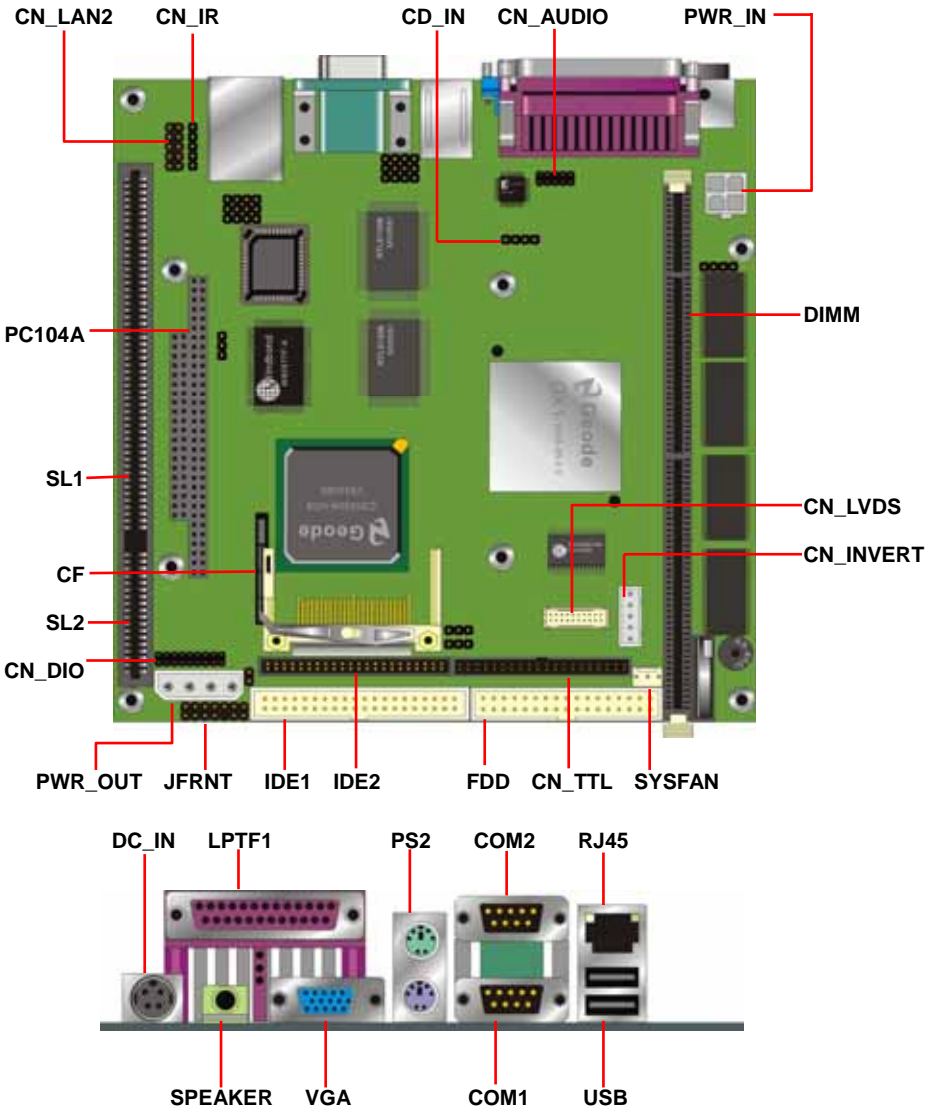

2.1.1 Jumper Location

Jumper	Function	Section
JRTC	RTC/CMOS Setting	
JDOM	DOM Power Setting (IDE1)	
JCFSEL	Compact Flash Card Address Setting	
JATX	AT/ATX Power Selection	
JVOLT1	LCD Driving Voltage Setting	
JCSEL1 / 2	COM2 RS-232/422/485 Mode Selection	

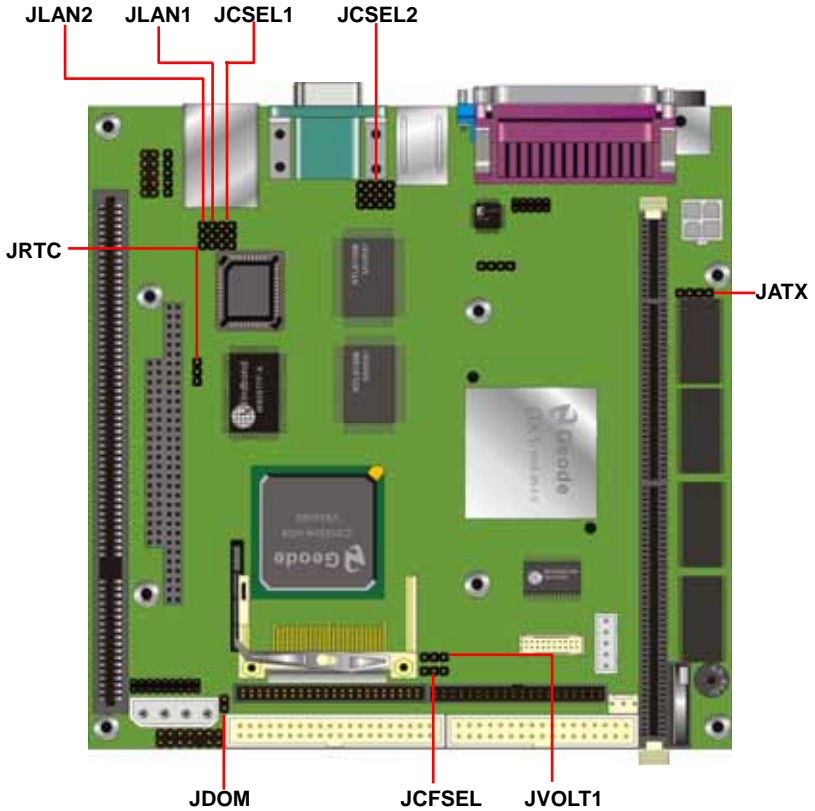

2.1.2 Connector Reference

Internal Connector

Connector	Function	Remark
CN_LAN2	10-pin Secondary LAN connector	Standard
CN_IR	5-pin IrDA connector	Standard
CD_IN	4-pin CD-in Audio Connector	Standard
CN_AUDIO	10-pin Audio Connector	Standard
PWR_IN	4-pin Power input connector	Standard
DIMM	168-pin SDRAM socket	Standard
PC104A	PC/104 ISA bus connector	Standard
SL1/SL2	16-bit/8-bit ISA slot	Standard
CF	Compact Flash Card Socket	Standard
CN_DIO	20-pin General Purpose I/O connector	Standard
PWR_OUT	4-pin Power output connector	Standard
JFRANT	14-pin Front Panel Jumper connector	Standard
IDE1	40-pin Primary IDE connector	Standard
IDE2	44-pin Secondary IDE connector	Standard
FDD	34-pin Floppy connector	Standard
CN_TTL	40-pin TTL LCD connector	Standard
SYSFAN	3-pin System fan connector	Standard
CN_LVDS	20-pin LVDS digital LCD connector	Standard
CN_INVERT	5-pin LCD panel inverter connector	Standard

External Connector

Connector	Function
DC_IN	DC adapter connector
LPTF1	External DB25 Printer Port
COM1/COM2	External COM1/COM2 Connector (DB9)
PS2	External PS/2 K/M & MS Connector
VGA	External DB15 VGA port
SPEAKER	External speaker jack
RJ45	External LAN port
USB	External dual USB port

2.2 CPU and DRAM setting

The board is based on NS Geode x86 compliant RISC architecture and offers the low power CPU for the embedded application with its onboard NS GX1 300 MHz CPU.

The system memory offers onboard 32/64/128MBytes SDRAM and one 168-pin DIMM socket supports up to 256 MB of Ram module. The total memory capacity will be up to 384 MB.

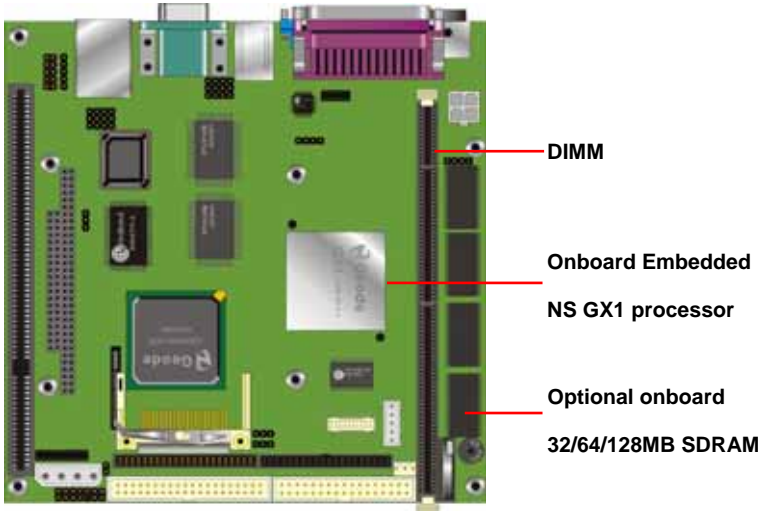

DIMM Installation Guide:

1. Please match the pin number according to the socket

2. Unlock the socket and put the memory module in to the socket well.

3. The hook will lock the module well.

2.3 CMOS setting

The board's data of CMOS can be setting in BIOS. If the board refuses to boot due to inappropriate CMOS settings, here is how to proceed to clear (reset) the CMOS to its default values.

Jumper: **JRTC**

Type: onboard 3-pin header

JRTC	Mode
1-2	Clear CMOS
2-3	Normal Operating
Default setting	

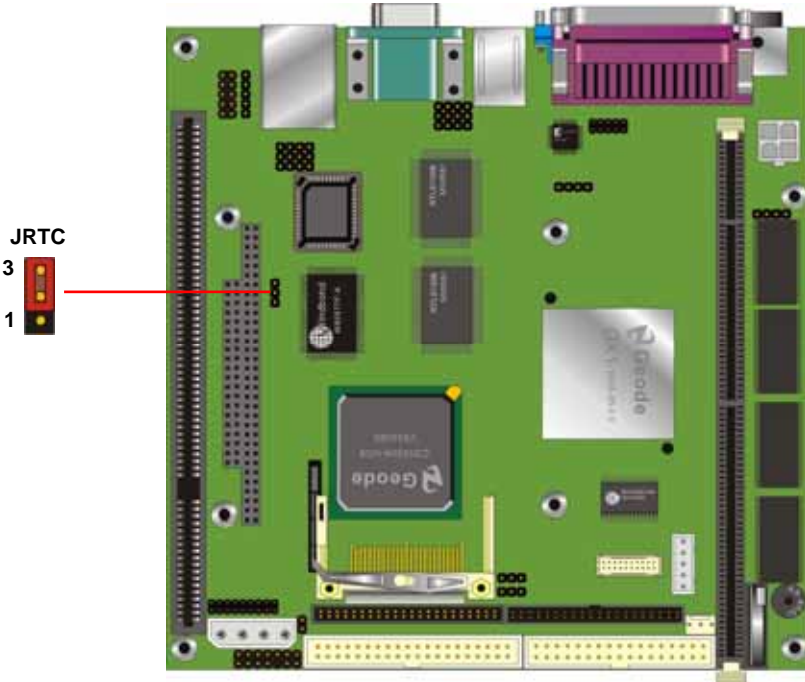

2.4 Embedded Solid State Disk

The board supports DOM (Disk On Module) and Compact Flash Type I/II socket. Both of them are bootable and driver free flash disk.

2.4.1 DiskOnModule (DOM)

Jumper: **JDOM**

Type: Onboard 2-pin header

JDOM	+5V on Pin-20 of IDE1
OFF	Disable
ON	Enable

Default setting

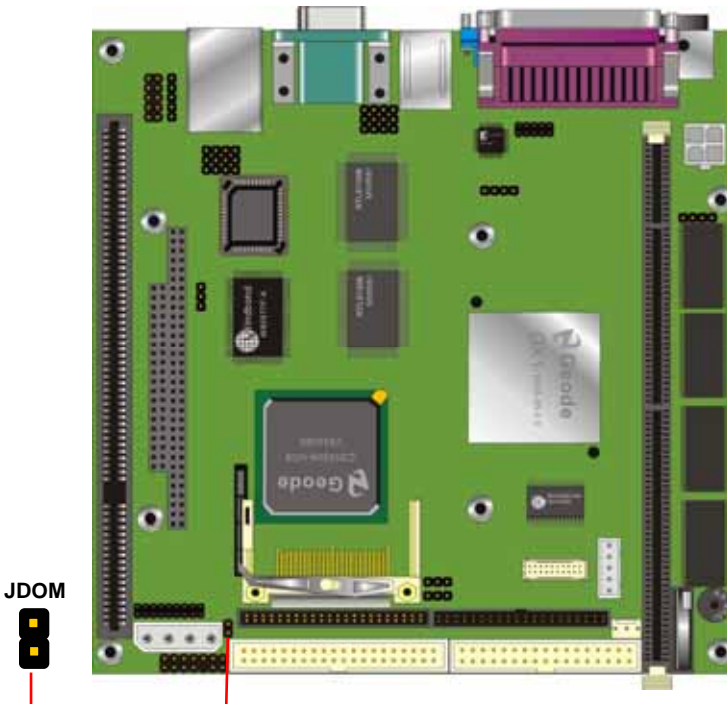

2.4.2 Compact Flash Socket

The compact flash card address is selectable as Master or Slave by jumper JCFSEL.

Jumper: **JCFSEL**

Type: onboard 3-pin header

JCFSEL	Mode
1-2	Master
2-3	Slave

Default setting

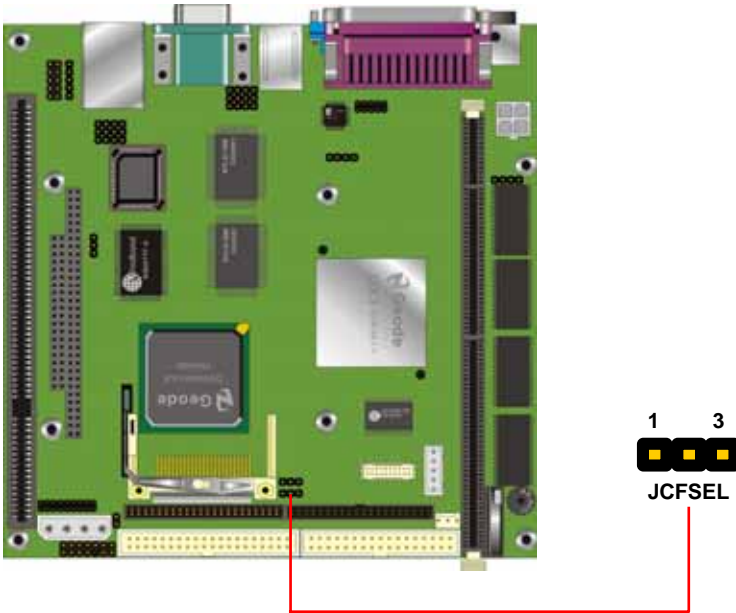

2.5 Power Configuration

The board has a standard 4-pin P4 use power connector, and a 4-pin DC jack for adapter. Also it provides a 4-pin power output connector for HDD or CD-ROM.

The board has two types of powering by jumper selectable as **JATX**. When you select the AT mode, after you switching the power supply on, the board will boot up immediately; when you select the ATX mode, after you switching the power supply on, you need to short the power button by the JFRNT in order to boot up the board.

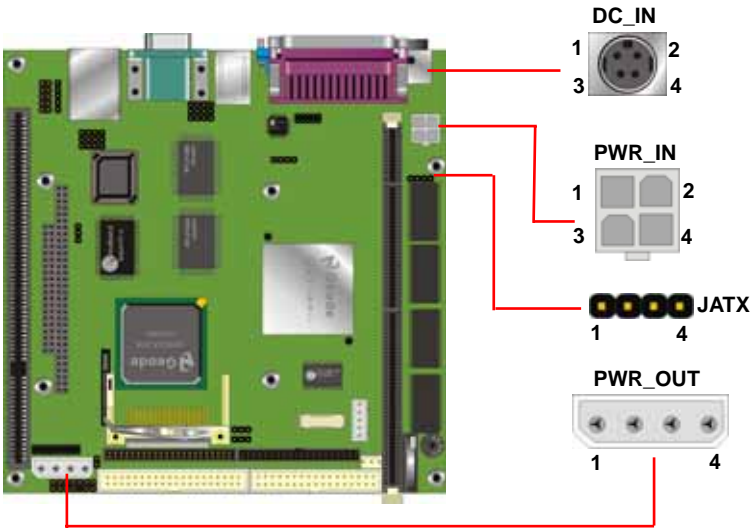

Jumper: **JATX**

Type: onboard 3-pin header

JATX	Mode
1-2	ATX
3-4	AT

Default setting

Connector: **DC_IN**

Type: 4-pin DC power connector

Pin	Description	Pin	Description
1	+12V	2	+12V
3	Ground	4	Ground

Connector: **CN_12V**

Type: 4-pin standard Pentium 4 +12V power connector

Pin	Description	Pin	Description
1	Ground	2	Ground
3	+12V	4	+12V

Connector: **PWR_OUT**

Type: 4-pin P-type connector for +5V/+12V output

Pin	Description	Pin	Description	Pin	Description	Pin	Description
1	+12V	2	Ground	3	Ground	4	+5V

Notice!!! Please do not plug any power input connector into PWR_OUT, this may hurt the board.

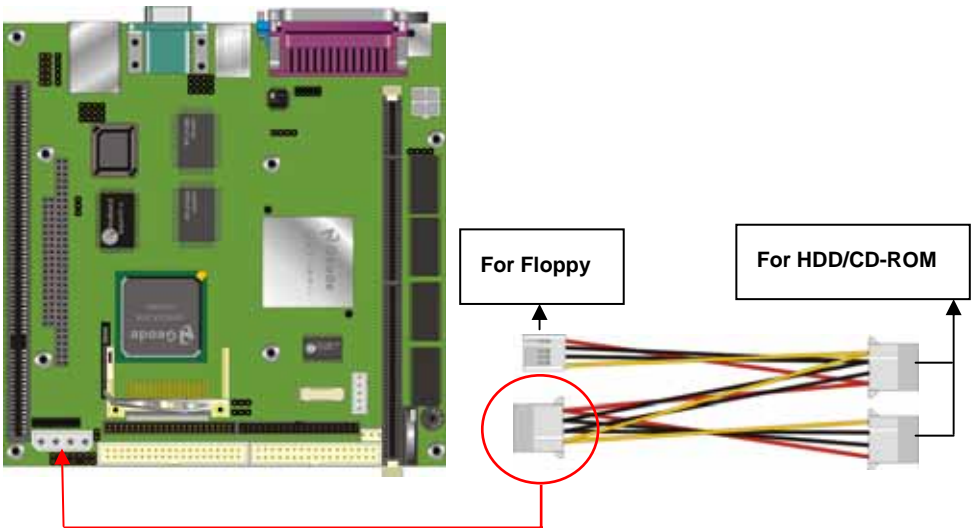

2.6 Display Interface

2.61 Standard CRT VGA interface

The board is integrated with NS Geode CS5530 chipset's built-in VGA controller with 2D engine and the video memory up to 4MB shared with system memory. The CRT / analog VGA interface supports standard DB15 CRT port.

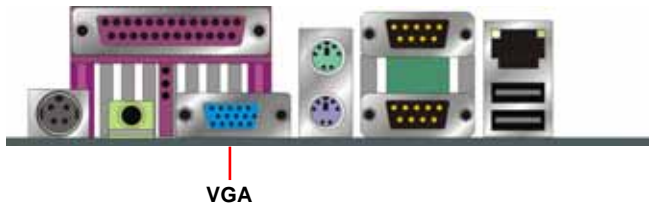

2.62 Digital LCD VGA interface

The board's digital video interface provides both of TTL and LVDS for different types of TFT LCD flat panel. The built-in 18-bit LVDS interface offers the economical solution for LVDS-based LCD display. All of the digital video interfaces used BIOS selectable video memory up to 4 Mbytes shared with system memory.

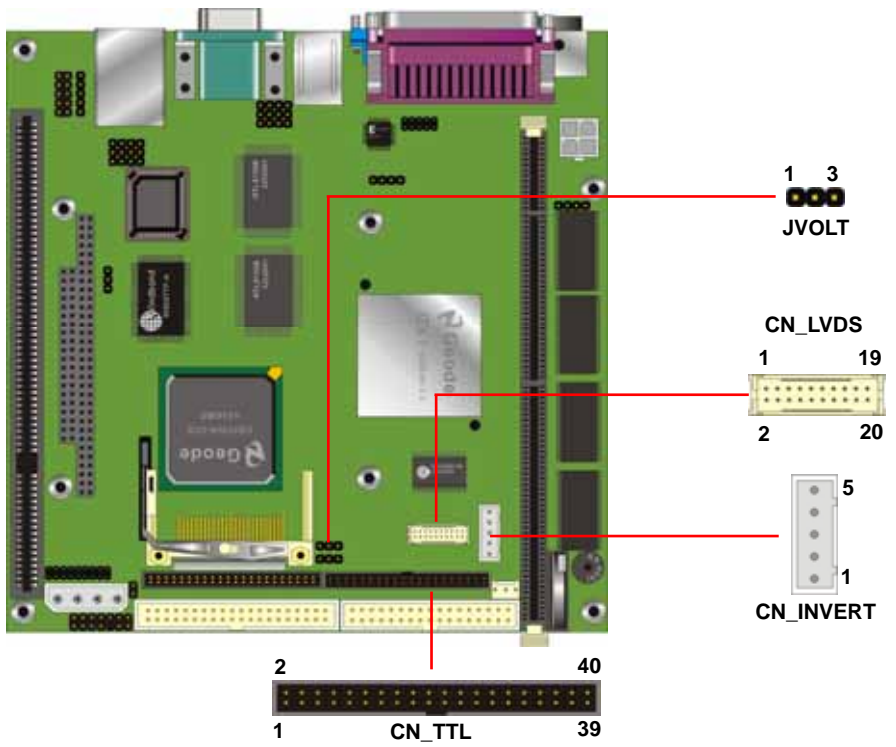

In order to setup the LCD display well, please check the jumper setting before you use.

Jumper: **JVOLT**

Type: onboard 3-pin header

JVOLT	Mode
1-2	+5V
2-3	+3.3V

Default setting

Connector: **CN_INVERT**

Type: onboard 5-pin header

Pin	Description
1	+12V
2	Ground
3	Ground
4	Ground
5	VCC

Connector: **CN_LVDS**

Type: 20-pin header (10 x 2 pitch 2.0 mm)

Connector model: Hirose DF13-20S

Pin	Signal	Pin	Signal
1	LCDVCC	2	LCDVCC
3	GND	4	GND
5	TXA-	6	TXA+
7	GND	8	TXB-
9	TXB+	10	GND
11	TXC-	12	TXC+
13	GND	14	TCLK-
15	TCLK+	16	GND
17	N/C	18	N/C
19	Ground	20	GND

Connector: **CN_TTL**

Type: onboard 2 x 20-pin header with housing, pitch=2.0mm

Pin	Signal	Pin	Signal
1	ENAVDD	2	ENBKL
3	GND	4	GND
5	LCDVCC	6	LCDVCC
7	N/C	8	GND
9	N/C	10	N/C
11	FPD0	12	FPD1
13	FPD2	14	FPD3
15	FPD4	16	FPD5
17	N/C	18	N/C
19	FPD6	20	FPD7
21	FPD8	22	FPD9
23	FPD10	24	FPD11
25	N/C	26	N/C
27	FPD12	28	FPD13
29	FPD14	30	FPD15
31	FPD16	32	FPD17
33	GND	34	GND
35	SHFCLK	36	FLM
37	M	38	LP
39	GND	40	GND

To setup the LCD, you need the component below:

1. A panel (support up to 18-bit color) with TTL or LVDS interfaces.
2. An inverter for panel's backlight power.
3. A LCD cable and an inverter cable.

For the cables, please follow the pin assignment of the connector to make a cable, because every panel has its own pin assignment, so we do not provide a standard cable; please find a local cable manufacture to make cables.

LCD installing guide:

1. Prepare a panel, inverter and **2807604**.

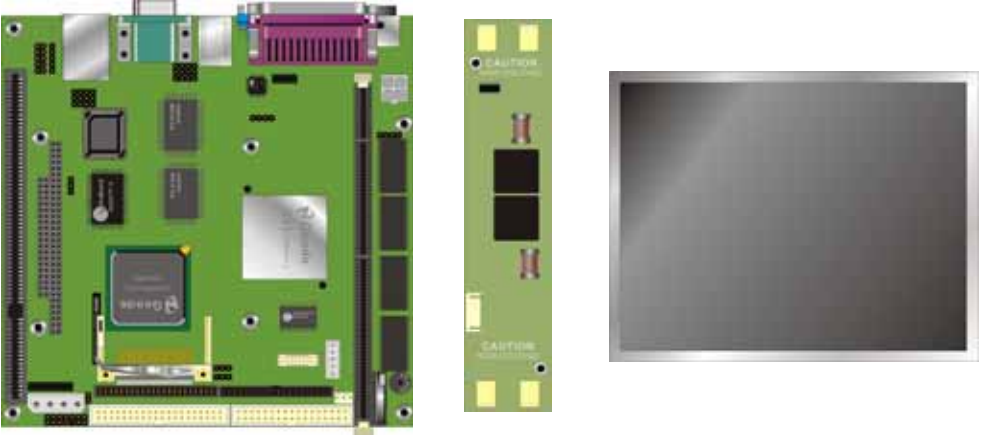

2. Please check the datasheet of the panel to see the voltage of the panel, and set the jumper **JVOLT** to +5V or +3.3V.
3. If your panel is for TTL interface, you would need a TTL type cable.



4. IF your panel is for LVDS interface, you would need a LVDS type cable.



5. Connect all the devices well.

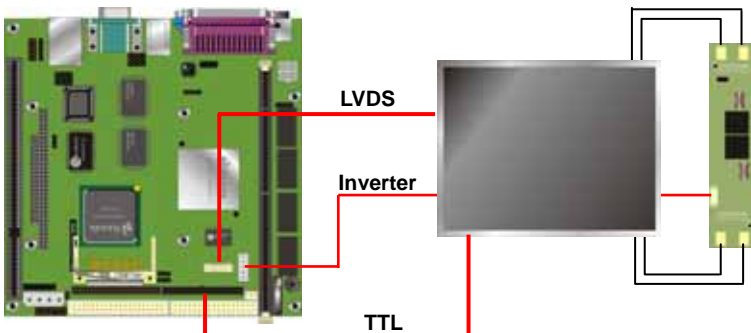

6. After hardware installing well, you need to select the panel type in the BIOS. The board supports the panel type of resolution are “640 x 480”, “800 x 600” and “1024 x 768”

ROM PCI/ISA BIOS (2A434E0B) INTEGRATED PERIPHERALS AWARD SOFTWARE, INC.	
IDE HDD Block Mode	: Enabled
Primary IDE Channel	: Enabled
Master Drive PIO Mode	: Auto
Slave Drive PIO Mode	: Auto
Secondary IDE Channel	: Enabled
Master Drive PIO Mode	: Auto
Slave Drive PIO Mode	: Auto
IDE Primary Master UDMA	: Auto
IDE Primary Slave UDMA	: Auto
IDE Secondary Master UDMA	: Auto
IDE Secondary Slave UDMA	: Auto
KBC input clock	: 8 MHz
Onboard FDC Controller	: Enabled
Onboard Serial Port 1	: 3F8/IRQ4
Onboard Serial Port 2	: 2F8/IRQ3
Onboard IR Controller	:
IR Address Select	: 3E0H
IR Mode	:
IR Transmission delay	: Enabled
IR IRQ Select	:
IR Mode Use DMA	: Disable
Onboard Parallel Port	:
Parallel Port Mode	:
ECP Mode Use DMA	:
EPP Mode Select	: EPP1.9
Build in CPU Audio	: Enabled
Audio I/O Base Address	: 220H
MPU-401 I/O Base Address	: 330H
Audio IRQ Select	: IRQ 5
Audio Low DMA Select	: DMA 1
Audio High DMA Select	: DMA 5
Multiple Monitor Support	: PCI First
Video Memory Size	: 4.0 M
Flat Panel Status	: Enabled
Flat Panel Resolution	: 640x480

2.7 Ethernet Interface

The board integrated with dual Fast Ethernet interfaces with Realtek RTL8100B at the type of 10Base-T/100Base-TX auto-switching Fast Ethernet with full duplex and IEEE 802.3U compliant. The first LAN port is connected with RJ45 on the real I/O panel, and the second LAN port is connected with 2 x 5-pin header onboard.

The jumper **JLAN1** and **JLAN2** can let you enable or disable the LAN controller.

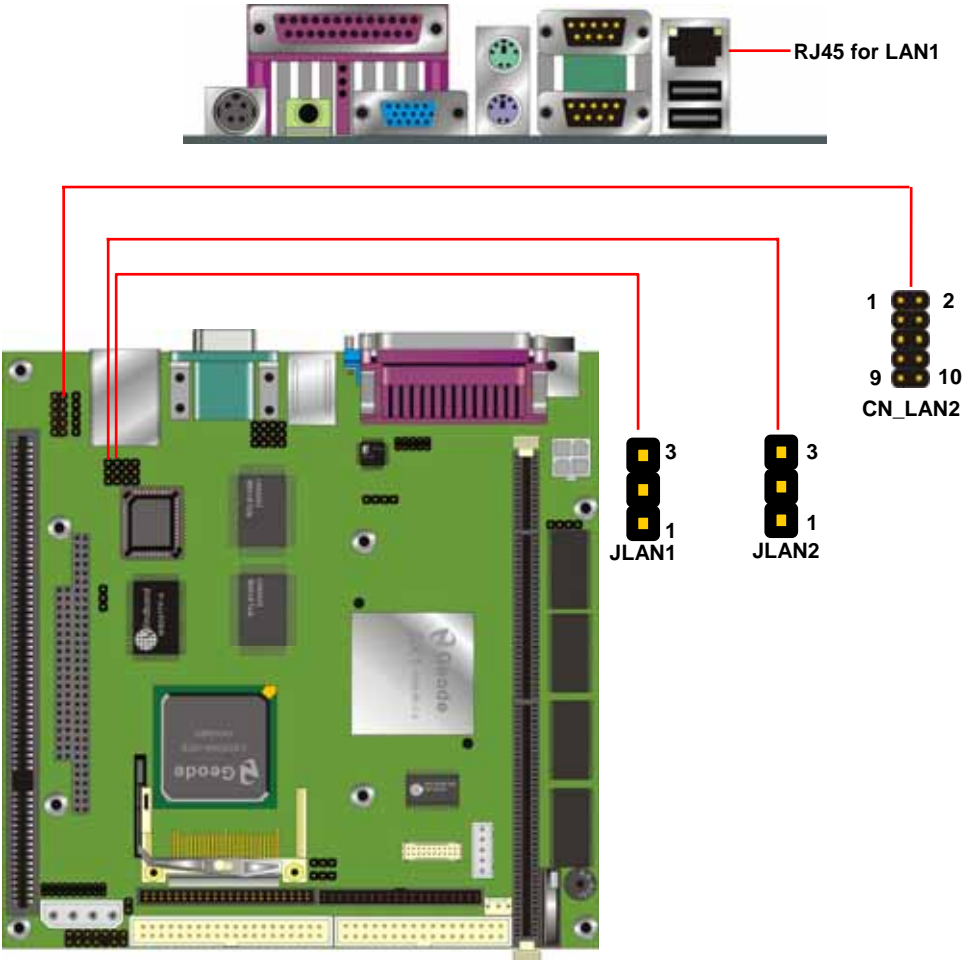

Jumper: **JLAN1/JLAN2**

Type: onboard 3-pin header

JLAN1/JLAN2 **Mode**

1-2 enable

2-3 disable

Default setting

Connector: **CN_LAN2**

Type: 10-pin header (10 x 2 pitch 2.5 mm)

Pin	Signal	Pin	Signal
1	LTX1+	2	LTX1-
3	LRX1+	4	GND
5	GND	6	LRX1-
7	LEDTX1	8	3VSB
9	LEDLINK1	10	3VSB

To use the LAN2 port, please get the 10-pin to 10-pin cable and AD_LAN module from the board package, connect them with the CN_LAN2 onboard properly.

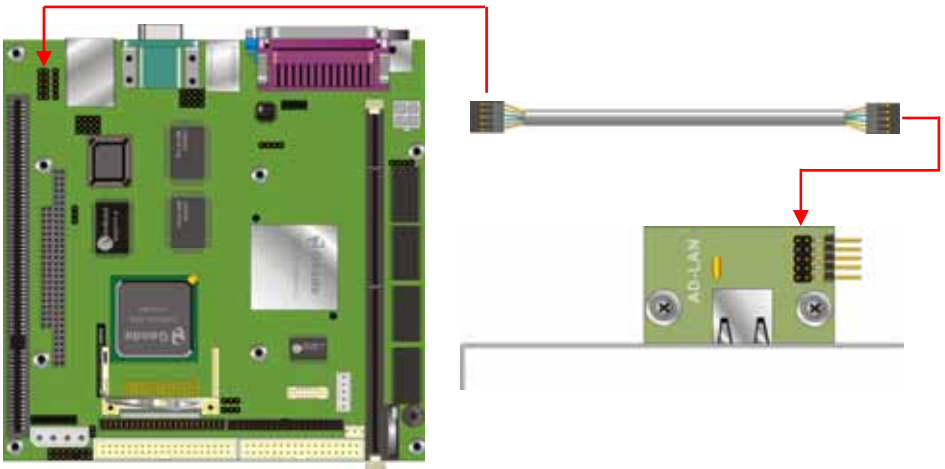

2.8 Audio Interface

The board supports onboard audio with Realtek ALC201A AC'97 codec for stereo sound. There is a speaker jack on the real I/O panel allows you to connect an amplified speaker; or you can use an optional 2 x 5-pin cable to connect the JAUDIO for Line-out, Line-in and MIC-out.

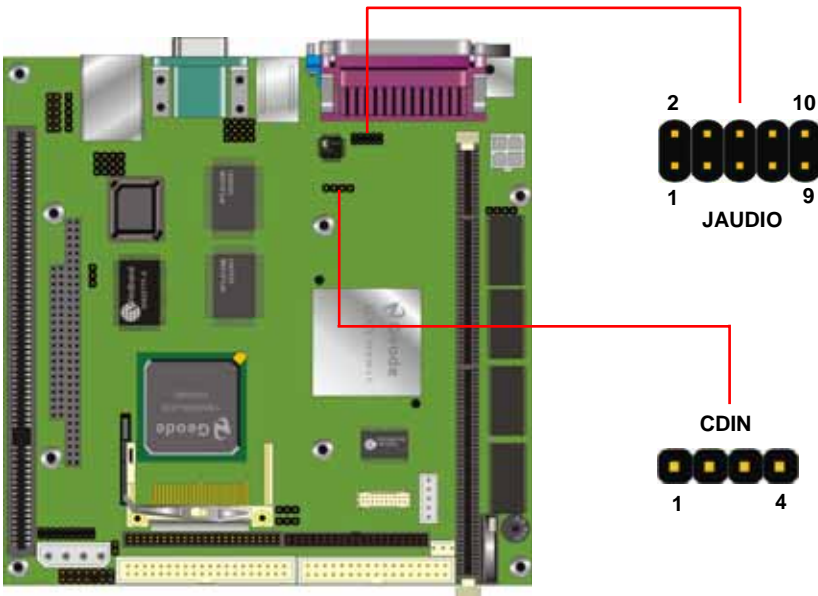

Connector: CN_AUDIO

Type: 10-pin (2 x 5) 2.54-pitch header

Pin	Description	Pin	Description
1	Line – Right	2	Ground
3	Line – Left	4	MIC
5	MIC	6	Ground
7	N/C	8	Line Out – Left
9	Line Out – Right	10	Ground

Connector: CDIN

Type: 4-pin header

Pin	Description
1	CD – Left
2	Ground
3	Ground
4	CD – Right

2.9 Serial Port Setup

The board provides one RS232 COM port on real I/O panel with DB9 as COM1, and a jumper selectable RS232/422/485 serial port on real I/O panel with DB9 as COM2. You can use JCSEL1 and JCSEL2 to set the COM2 mode.

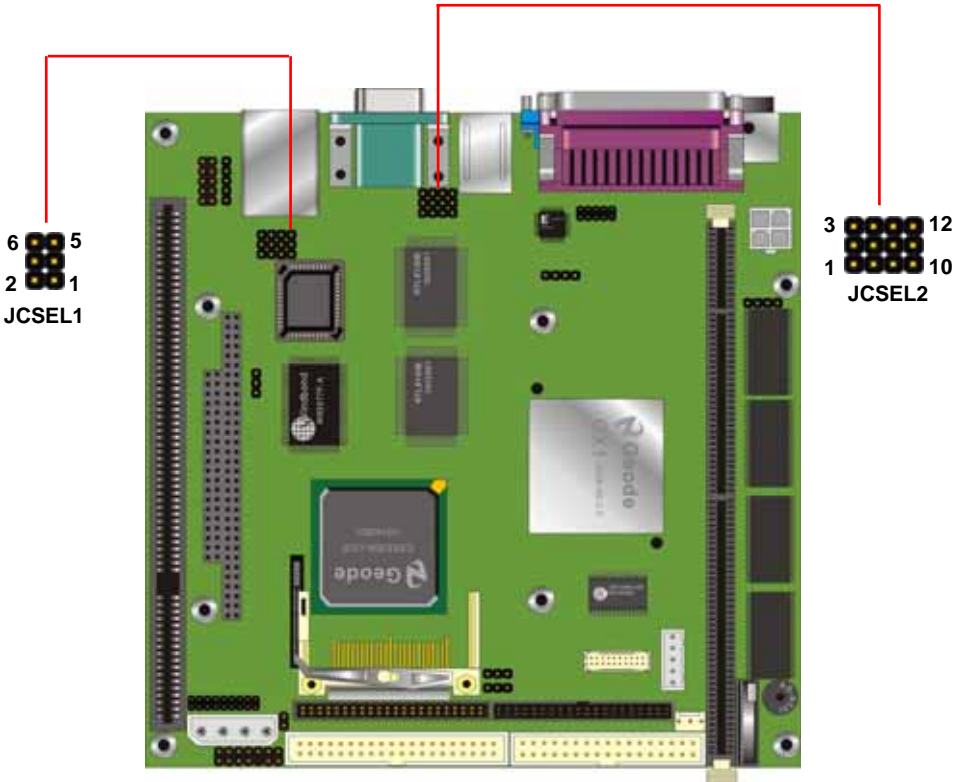
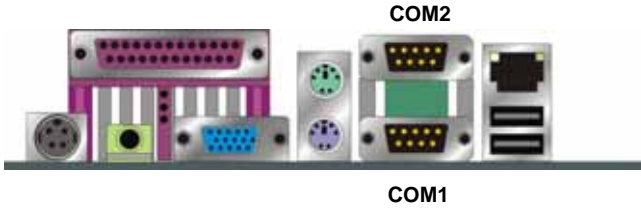

Jumper: **JCSEL1**

Type: onboard 2 x 3-pin header

JCSEL1	Mode
1-2	RS232
3-4	RS485
5-6	RS422

Default setting

Jumper: **JCSEL2**

Type: onboard 2 x 3-pin header

Mode	JCSEL2
RS232	1-2 / 4-5 / 7-8 / 10-11
RS485	2-3 / 5-6 / 8-9 / 11-12
RS422	2-3 / 5-6 / 8-9 / 11-12

Default setting

2.10 GPIO Interface

The board offers 16-bit digital I/O to customize its configuration to your control needs. For example, you may configure the digital I/O to control the opening and closing of the cash drawer or to sense the warning signal from a tripped UPS. The following is a detailed description of how the digital I/O is controlled via software programming.

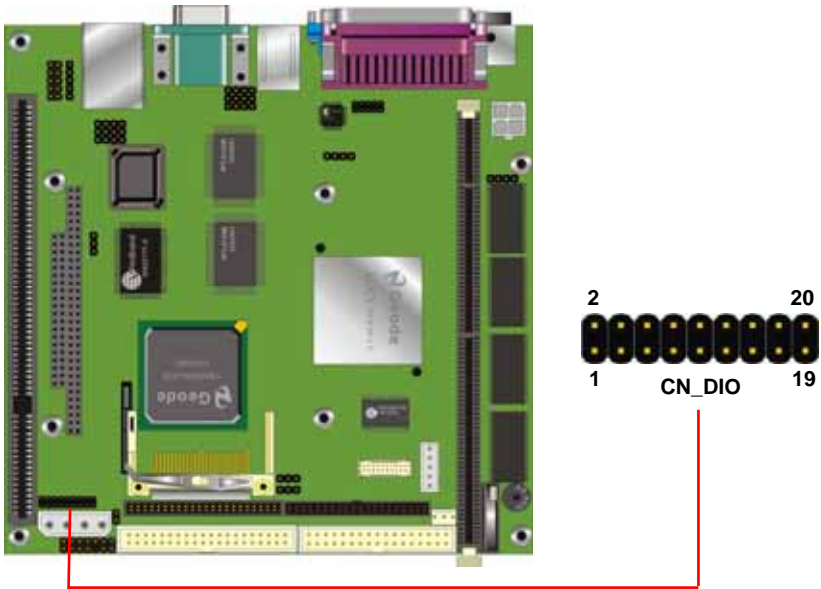

Connector: CN_DIO

Type: onboard 2 x 10-pin header, pitch=2.0mm

Pin	Description	Pin	Description
1	DOP0	2	DOP1
3	DOP2	4	DOP3
5	DOP4	6	DOP5
7	DOP6	8	DOP7
9	GND	10	GND
11	DIN0	12	DIN1
13	DIN2	14	DIN3
15	DIN4	16	DIN5
17	DIN6	18	DIN7
19	VCC	20	+12V

Digital Input / Output Programming

Function	Address	Bit
Digital Input #1	200	0
Digital Input #2	200	1
Digital Input #3	200	2
Digital Input #4	200	3
Digital Input #5	200	4
Digital Input #6	200	5
Digital Input #7	200	6
Digital Input #8	200	7
Digital Output #1	208	0
Digital Output #2	208	1
Digital Output #3	208	2
Digital Output #4	208	3
Digital Output #5	208	4
Digital Output #6	208	5
Digital Output #7	208	6
Digital Output #8	208	7

2.11 Switches and Indicators

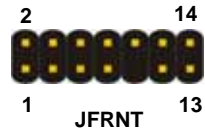
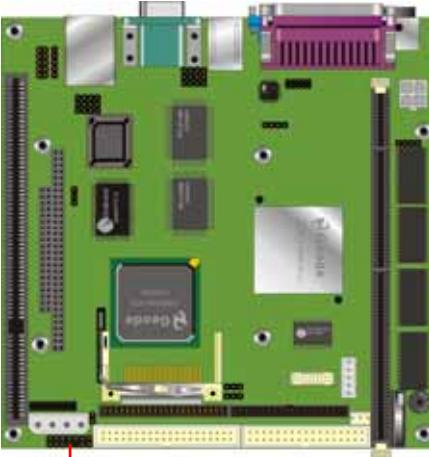

Connector: **JFRNT**

Type: onboard 14-pin (2 x 7) 2.54-pitch header

Function	Signal	PIN		Signal	Function
IDE LED	Vcc (+)	1	2	(+) Vcc	Power LED
	Active	3	4	N/C	
Reset	Reset	5	6	GND	Speaker
	GND	7	8	Vcc	
N/C		9	10	N/C	
Power Button	PWRBT	11	12	N/C	
	GND	13	14	SPKIN	

(This page is left for blank)

(This page is left for blank)

Chapter 3 BIOS setup

The single board computer uses the Award BIOS for the system configuration. The Award BIOS in the single board computer is a customized version of the industrial standard BIOS for IBM PC AT-compatible computers. It supports Intel x86 and compatible CPU architecture based processors and computers. The BIOS provides critical low-level support for the system central processing, memory and I/O sub-systems.

The BIOS setup program of the single board computer let the customers modify the basic configuration setting. The settings are stored in a dedicated battery-backed memory, NVRAM, retains the information when the power is turned off. If the battery runs out of the power, then the settings of BIOS will come back to the default setting. The BIOS section of the manual is subject to change without notice and is provided here for reference purpose only. The settings and configurations of the BIOS are current at the time of print, and therefore they may not be exactly the same as that displayed on your screen.

To activate CMOS Setup program, press key immediately after you turn on the system. The following message “Press DEL to enter SETUP” should appear in the lower left hand corner of your screen. When you enter the CMOS Setup Utility, the Main Menu will be displayed as **Figure 3-1**. You can use arrow keys to select your function, press <Enter> key to accept the selection and enter the sub-menu.

Figure 3-1. CMOS Setup Utility Main Screen

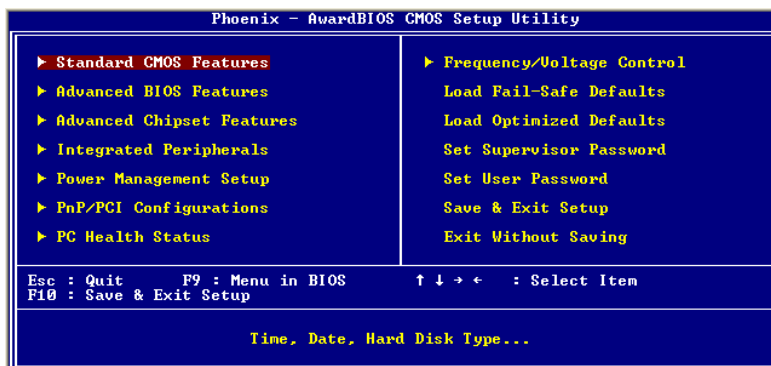

(This page is left for blank)

(This page is left for blank)

Chapter 4 Driver Installation

The driver CD contents the drivers for the board and the manual as PDF file. The driver CD can run automatically while you insert the disk into CD-ROM.

Notice: the auto-run can be run under Windows 98, Windows 98SE, Windows NT4.0 Windows ME, Windows 2000 and Windows XP.



(This page is left for blank)

(This page is left for blank)

Appendix. A I/O Port Pin Assignment

A.1 IDE Port

Connector: IDE1

Type: 40-pin (2 x 20) box header

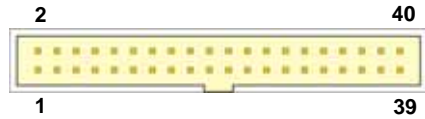

Pin	Description	Pin	Description
1	Reset	2	Ground
3	D7	4	D8
5	D6	6	D9
7	D5	8	D10
9	D4	10	D11
11	D3	12	D12
13	D2	14	D13
15	D1	16	D14
17	D0	18	D15
19	Ground	20	N/C (Vcc)
21	REQ	22	Ground
23	IOW-/STOP	24	Ground
25	IOR-/HDMARDY	26	Ground
27	IRDY/DDMARDY	28	IDESEL
29	DACK-	30	Ground
31	IRQ	32	N/C
33	A1	34	CBLID
35	A0	36	A2
37	CS0 (MASTER CS)	38	CS1 (SLAVE CS)
39	LED ACT-	40	Ground

Connector: IDE2

Type: 44-pin (2 x 22) box header



Pin	Description	Pin	Description
1	Reset	2	Ground
3	D7	4	D8
5	D6	6	D9
7	D5	8	D10
9	D4	10	D11
11	D3	12	D12
13	D2	14	D13
15	D1	16	D14
17	D0	18	D15
19	Ground	20	N/C
21	REQ	22	Ground
23	IOW-/STOP	24	Ground
25	IOR-/HDMARDY	26	Ground
27	IORDY/DDMARDY	28	Ground
29	DACK-	30	Ground
31	IRQ	32	N/C
33	A1	34	SD
35	A0	36	A2
37	CS1	38	CS3
39	ASP1	40	Ground
41	Vcc	42	Vcc
43	Ground	44	Ground

A.2 Floppy Port

Connector: FDD

Type: 34-pin (2 x 17) header



Pin	Description	Pin	Description
1	Ground	2	DRIVE DENSITY SELECT 0
3	Ground	4	DRIVE DENSITY SELECT 1
5	Ground	6	N/C
7	Ground	8	INDEX-
9	Ground	10	MOTOR ENABLE A-
11	Ground	12	DRIVER SELECT B-
13	Ground	14	DRIVER SELECT A-
15	Ground	16	MOTOR ENABLE B-
17	Ground	18	DIRECTION-
19	Ground	20	STEP-
21	Ground	22	WRITE DATA-
23	Ground	24	WRITE GATE-
25	Ground	26	TRACK 0-
27	Ground	28	WRITE PROTECT-
29	Ground	30	READ DATA-
31	Ground	32	HEAD SELECT-
33	Ground	34	DISK CHANGE-

A.3 Parallel Port

Connector: LPTF1

Connector Type: 25-pin D-sub female connector on bracket



Pin	Description	Pin	Description
1	PPSTBX	14	PPAFDX
2	PPD0	15	PPERX
3	PPD1	16	PPINITX
4	PPD2	17	PPSLINX
5	PPD3	18	GND
6	PPD4	19	GND
7	PPD5	20	GND
8	PPD6	21	GND
9	PPD7	22	GND
10	ACK-	23	GND
11	BUSY	24	GND
12	PPPE	25	GND
13	PPSLCT		

A.4 Serial Port

Connector: **COM1/COM2**

Connector Type: 9-pin D-sub male connector on bracket

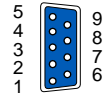

Pin	Description	Pin	Description
1	DCD	2	RXD
3	TXD	4	DTR
5	Ground	6	DSR
7	RTS	8	CTS
9	RI		

A.5 IrDA port

Connector: **CN_IR**

Type: 5-pin (1 x 5) header for SIR Port



Pin	Description
1	Vcc
2	N/C
3	IRRX
4	Ground
5	IRTX

A.6 VGA Port

Connector: **VGA**

Type: 15-pin D-sub female connector on bracket

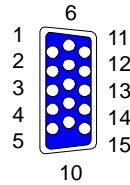

Pin	Description	Pin	Description	Pin	Description
1	RED	6	Ground	11	N/C
2	GREEN	7	Ground	12	5VCCA
3	BLUE	8	Ground	13	HSYNC
4	N/C	9	LVGA5V	14	VSYNC
5	Ground	10	Ground	15	5VCLK

A.7 LAN Port

Connector: **RJ45**

Type: RJ45 connector with LED on bracket

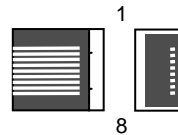

Pin	1	2	3	4	5	6	7	8
Description	TX+	TX-	RX+	N/C	N/C	RX-	N/C	N/C

(This page is left for blank)

(This page is left for blank)

Appendix B Flash the BIOS

B.1 BIOS Auto Flash Tool

The board is based on Award BIOS and can be updated easily by the BIOS auto flash tool. You can download the tool online at the address below:

<http://www.award.com>

File name of the tool is “awdf flash.exe”, it’s the utility that can write the data into the BIOS flash ship and update the BIOS.

B.2 Flash Method

1. Please make a bootable floppy disk.
2. Get the last .bin files you want to update and copy it into the disk.
3. Copy awardflash.exe to the disk.
4. Power on the system and flash the BIOS. (Example: C:/ awardflash XXX.bin)
5. Re-star the system.

Contact Information

Any adviser or comment about our products and service, or anything we can help you please don't hesitate to contact with us. We will do our best service for you.



Global American Inc.

Address 17 Hampshire Drive Hudson

NH 03051

USA

TEL 1-603-886-3900

FAX 1-603-886-4545

Website: www.globalamericaninc.com
