



integration with integrity

User's Manual

ATX Motherboard 2807770

Version 1.0, October 2007

Copyrights

This manual is copyrighted and all rights are reserved. It does not allow any non authorization in copied, photocopied, translated or reproduced to any electronic or machine readable form in whole or in part without prior written consent from the manufacturer.

In general, the manufacturer will not be liable for any direct, indirect, special, incidental or consequential damages arising from the use of inability to use the product or documentation, even if advised of the possibility of such damages. The manufacturer keeps the rights in the subject to change the contents of this manual without prior notices in order to improve the function design, performance, quality and reliability. The author assumes no responsibility for any errors or omissions, which may appear in this manual, nor does it make a commitment to update the information contained herein.

Trademarks

Intel is a registered trademark of Intel Corporation.

Award is a registered trademark of Award Software, Inc.

All other trademarks, products and or product's name mentioned herein are mentioned for identification purposes only, and may be trademarks and/or registered trademarks of their respective companies or owners.

Packing List

Please check package component before you use our products.

Hardware:

2807770 Full size ATX motherboard x 1

Cable Kit:



Floppy flat cable x 1

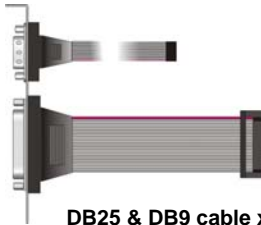

DB25 & DB9 cable x 1



Serial ATA ribbon cable x 2

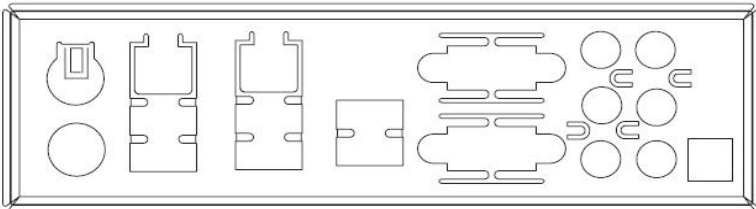

I/O Shield x 1

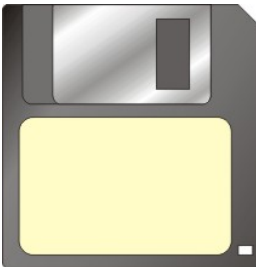

RAID driver Disk for Windows 2000,
Windows XP and Windows Server 2003

Other Accessories:

Divers CD (including User's Manual) x 1

Index

Chapter1 <Introduction>	6
1.1 <Product Overview>.....	6
1.2 <Product Specification>	7
1.3 <Component Placement>	9
1.4 <Block Diagram>.....	10
1.5 <Mechanical Drawing >.....	11
Chapter 2 <Hardware Setup>	12
2.1 <Connector Location>.....	12
2.2 <Jumper Location>	13
2.3 <Connector Reference>	14
2.3.1 <Internal Connectors>	14
2.3.2 <External Connectors>	14
2.4 <CPU and Memory Setup>	15
2.4.1 <CPU installation>.....	15
2.4.2 <Memory installation>.....	16
2.5 <CMOS Setup>	17
2.6 <Serial ATA installation>	18
2.7 <Floppy Installation>	19
2.8 <LAN installation>	20
2.9 <Audio Installation>.....	21
2.10 <Display Installation>	23
2.11 <USB Installation>.....	24
2.12 <Power and Fan Installation>	26
2.13 <GPIO & SMBUS interface>	28
2.14 <Serial Port>	29
2.15 <Switch & Indicator>	31
2.16 <Expansion Interface>	32

Chapter 3 <System Configuration>	34
3.1 <SATA configuration>.....	34
3.2 <SATA RAID Configuration>	35
3.3 <Audio Configuration>	39
3.4 <Video Memory Setup>	40
Appendix A <I/O Port Pin Assignment>	44
A.1 <Floppy Port>	44
A.2 <Serial Port>.....	45
A.3 <VGA Port>.....	45
A.4 <LAN Port>	46
A.5 <SMBus>	46
A.6 <Parallel Port>	47
A.7 <IrDA Port>	47
Appendix B <System Resources>	48
Appendix C <Programming GPIO's>	53
Appendix D <What Dog timer Setting >	54
Contact Information	55

(This page is left for blank)

Chapter1 <Introduction>

1.1 <Product Overview>

2807770 is the motherboard with last Intel desktop technology with industrial motherboard form factor. Based on Intel® Q965 and ICH8DO, the board integrates a new Core 2 Quad processor 775-pin socket, DDR2 memory slot, Intel® Graphic Media Accelerator 3000 technology, PCI express interface and Serial ATA II with RAID function for a powerful desktop system.

Intel® LGA775 processor

The Intel® Core 2 Quad processor now comes with a new form factor with 775-pin PLGA package, for 533/800/1066MHz front-side-bus, 4MB L2 cache, and for 65nm manufacturing technology, the PLGA processor without pin header on solder side can make user installing the processor on the socket easier.

Intel® Q965 and ICH8DO chipset

The Intel Q965 integrates DDR2 533/667/800MHz for memory, and Graphic Media Accelerator (GMA) 3000 technology for new graphic engine. It can provide up to 256MB of frame buffer when you install over 512MB of system memory. The ICH8DO integrates with up to 10 USB2.0 interfaces (6 ports for 2807770) I/O panel, and serial ATA II interface with RAID function.

Dual Intel 82573L Gigabit LAN

Dual Gigabit LAN with Intel 82573L, 2807770 comes with a powerful network function for the system that requires large transfer data of NAS system or Server platform.

PCI-Express interface

2807770 integrates one x16 and x4 PCI-Express interface, it can provide up to 8GB/s of bandwidth, which AGP 8x can only provide up to 2GB/s.

Multimedia interfaces

2807770 also integrates 7.1 channel HD audio, Mini-PCI, PCI and ISA interface, for these flexible function, system integrator can built more powerful systems for many applications.

1.2 <Product Specification>

General Specification

Form Factor	Full size ATX motherboard
CPU	Intel® Core 2 Quad/Core 2 Duo/Pentium 4/Pentium D/Celeron D series processor with LGA775 socket Package type: PLGA 775 Front side bus: 533/800/1066MT/s (133/200/266/QuadMHz x 4) Intel® Hyper-Threading Technology and Dual/Quad core supported, EM64T supported
Memory	4 x 240-pin DDR2 533/667/800MHz SDRAM up to 8GB Unbuffered, none-ECC memory supported only
Chipset	Intel® Q965 (Northbridge) and ICH8DO (Southbridge)
BIOS	Phoenix-Award v6.00PG 8Mb SPI flash BIOS
Green Function	Power saving mode includes doze, standby and suspend modes. ACPI version 1.0 and APM version 1.2 compliant
Watchdog Timer	System reset programmable watchdog timer with 1 ~ 255 sec./min. of timeout value
Real Time Clock	Intel® ICH8DO built-in RTC with lithium battery
Serial ATAII	Intel® ICH8DO integrates 6 Serial ATA II interface RAID 0, 1,5,10 Intel Matrix Storage Technology supported

Multi-I/O Port

Chipset	Intel® 82801HDO(ICH8DO) with Winbond® W83627DHG and Fintek F81216D controller
Serial Port	Five RS-232 and one RS232/422/485 serial ports
USB Port	Ten Hi-Speed USB 2.0 ports with 480Mbps of transfer rate
Parallel Port	One internal bi-direction parallel port with SPP/ECP/EPP mode
Floppy Port	One internal Floppy port
IrDA Port	One IrDA compliant Infrared interface supports SIR
K/B & Mouse	External PS/2 keyboard and mouse port on rear I/O
GPIO	One 12-pin Digital I/O connector with 8-bit programmable I/O interface
Smart Fan	One CPU fan connector for fan speed controllable

VGA Display Interface

Chipset	Intel® Q965 GMA3000 (Graphic Memory Controller Hub)
Frame Buffer	Up to 256MB shared with system memory
Connector	External DB15 female connector on rear I/O

2807770 User's Manual

Ethernet Interface

Controller	Two Intel 82573L Gigabit Ethernet controller
Type	Triple speed 10/100/1000Base-T Auto-switching Fast Ethernet Full duplex, IEEE802.3U compliant
Connector	Two External RJ45 connectors with LED on rear I/O

Audio Interface

Chipset	Intel integrated with Realtek ALC888 HD Audio Intel High Definition Audio compliance
Interface	7.1 channels sound output
Connector	External Audio phone jack for Line-out, Line-in, MIC-in, Surround, Center and Backsurround Onboard front audio connector with pin header Onboard CD-IN and external optical S/PDIF connector

Expansive Interface

PCI-Express	One x16 PCI-Express slot (compatible with x1 slot) One x4 PCI-Express slot (compatible with x 1 slot) Up to 8GB/s of transfer bandwidth Power supply: +3.3V, +12V
PCI	Four-PCI slot (32-bit, 33MHz) Power supply: +3.3V, +5V, +12V, -12V
Mini PCI	One Mini-PCI socket TYPE III A (32-bit, 33MHz) Power supply: +3.3V, +5V, 3VSB
ISA	Two ISA slots (without DMA supported)

Power and Environment

Power Requirement	Standard 24-pin ATX power supply (20-pin is compatible) Standard 8-pin 12v power Input connector (4-pin is compatible)
Dimension	307mm x 244mm (L x W)
Temperature	Operating within 0 ~ 60°C (32 ~ 140°F) Storage within -20 ~ 85°C (-4 ~ 185°F)

Ordering Code

2807770	Support Intel Core 2 Quad LGA775 with DDRII, Onboard VGA, Dual Intel Gigabit LAN 10 x USB2.0, Realtek ALC888 HD Audio, 6 x COM Ports, GPIO, SATA and ISA slot
----------------	---

For further product information please visit the website at <http://www.globalamericaninc.com>

1.3 <Component Placement>

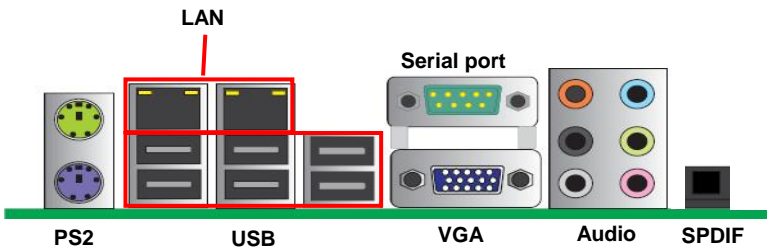
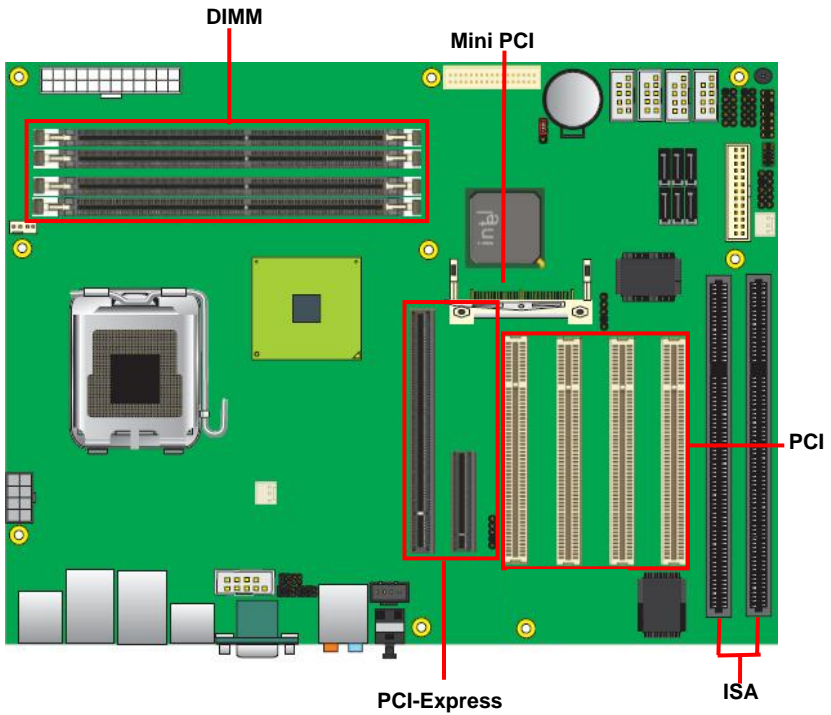

1.4 <Block Diagram>

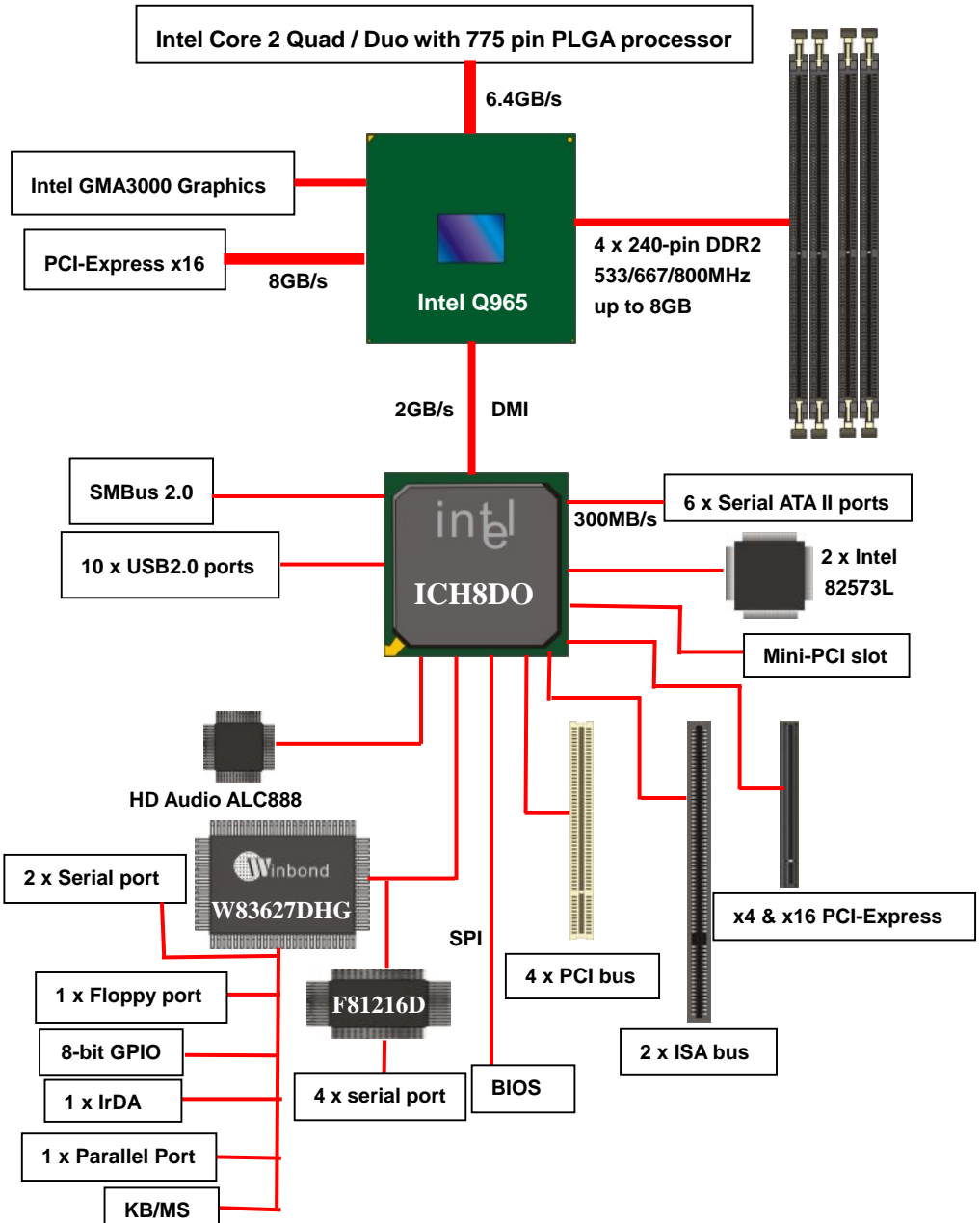

1.5 <Mechanical Drawing >

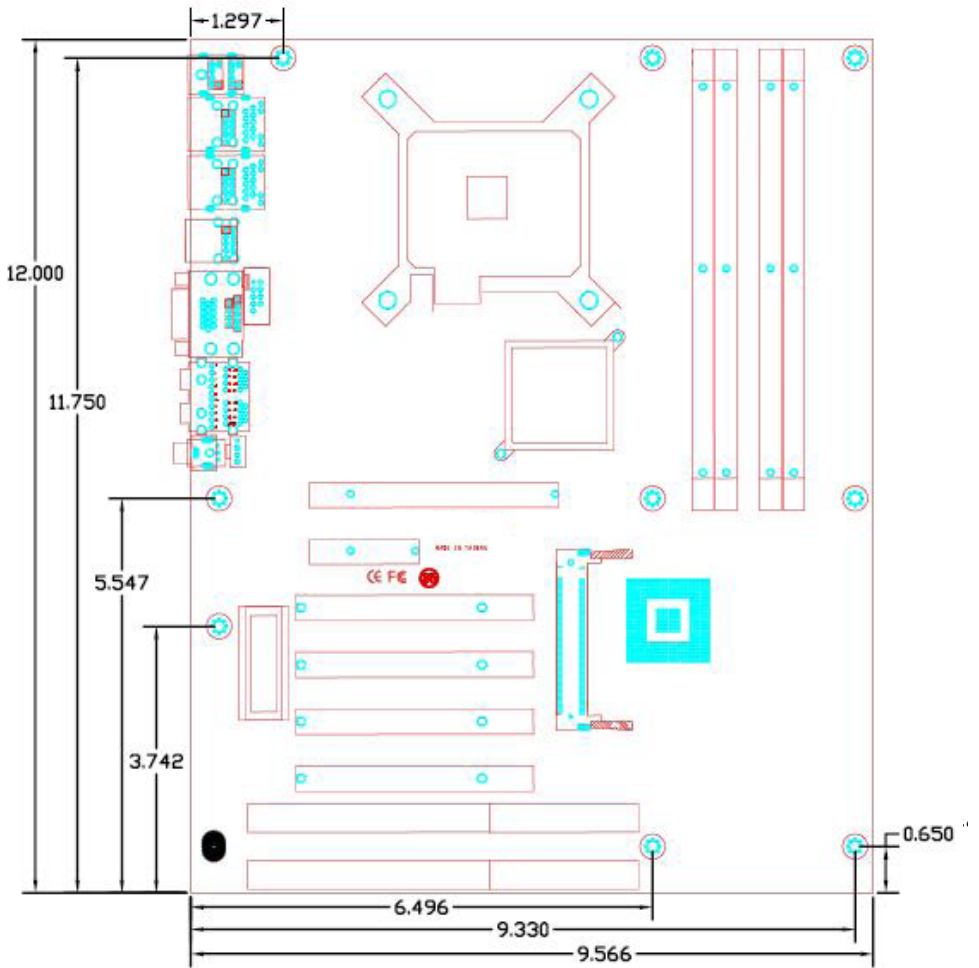

Chapter 2 <Hardware Setup>

2.1 <Connector Location>

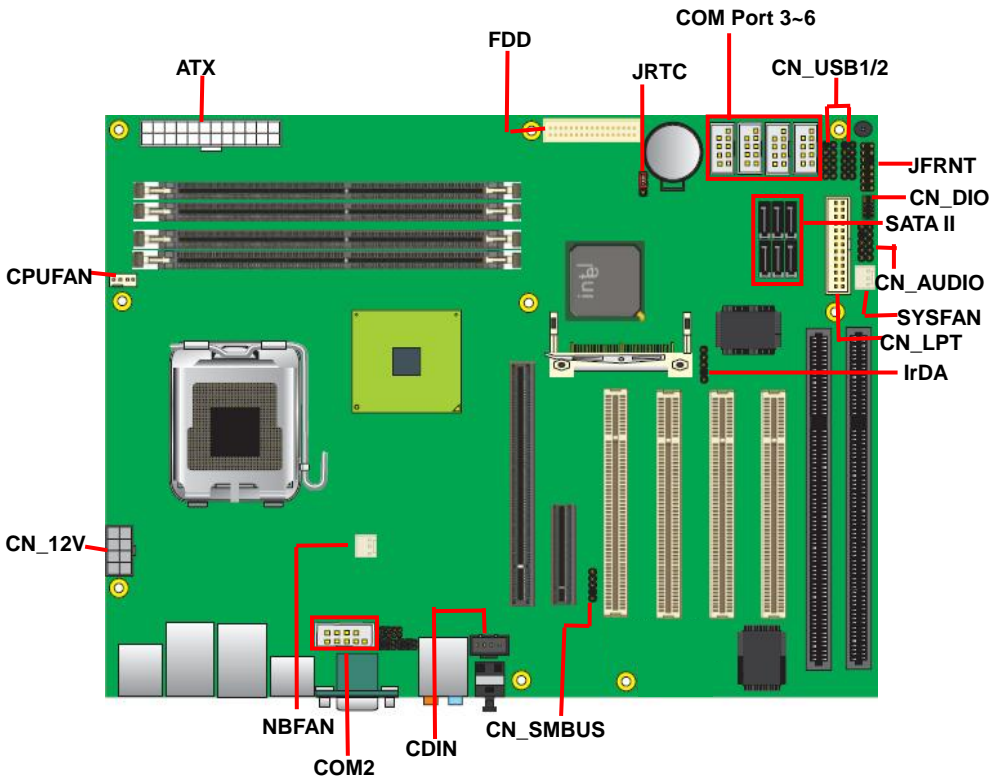

2.2 <Jumper Location>

Jumper	Function
JRTC	CMOS Operating/Clear Setting

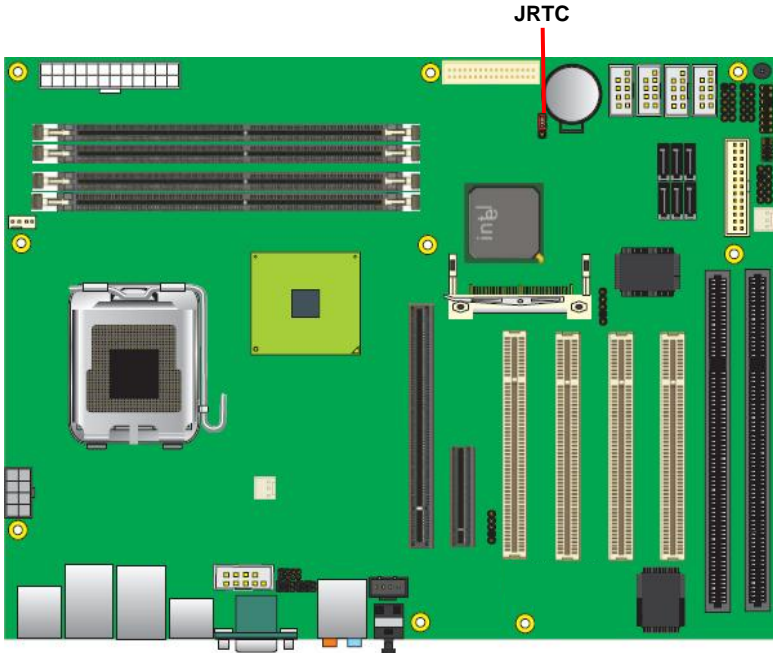

2.3 <Connector Reference>

2.3.1 <Internal Connectors>

Connector	Function
CPU	PLGA775 CPU socket
DDR11/2/3/4	240 -pin DDR2 SDRAM DIMM socket
S_ATA11/2/3/4/5/6	7-pin Serial ATA II connector
ATX	24-pin power supply connector
CN_12V	8-pin +12V additional power supply connector
CN_AUDIO	5 x 2-pin audio connector
CDIN	4-pin CD-ROM audio input connector
CN_DIO	6 x 2-pin digital I/O connector
CN_USB1/2	10-pin USB connector
CPUFAN	4-pin CPU cooler fan connector
SYSFAN	3-pin system cooler fan connector
NBFAN	3-pin Northbridge cooler fan connector
CN_IR	5-pin IrDA connector
CN_SMBUS	5-pin I ² C connector
JFRNT	14-pin front panel switch/indicator connector
FDD	26-pin slim type floppy connector
CN_COM2~6	5 x 2-pin com connector

2.3.2 <External Connectors>

Connector	Function
VGA	DB15 VGA connector
USB	Dual USB Ports
COM	DB9 Serial port connector
PS2	PS/2 Keyboard/Mouse connector
AUDIO	Audio connector
USB_RJ45_A/B	Quad USB and Dual RJ45 LAN connectors
SPDIF	Optical SPDIF digital audio output connector

2.4 <CPU and Memory Setup>

2.4.1 <CPU installation>

2807770 has a PLGA775 CPU socket onboard; please check following steps to install the processor properly.

Attention If 2807770 need RMA, please Keep CPU socket cover on the CPU Socket.
Warning If CPU Socket internal Pin damage, we could not provide warranty.



Intel® Core 2 Quad/Duo processor
Package type: 775 pin PLGA
L2 Cache: 4MB
FSB: 533/800/1066MT/S (266MHz x 4)
Manufacturing: 65nm, 90nm
Intel Hyper Threading Technology
And Core 2 Quad/Core 2 Duo support

1. Lift this bar

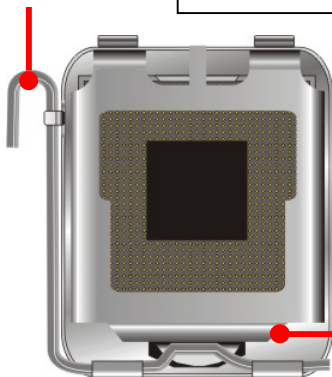

2. Uncover this plate



Check point

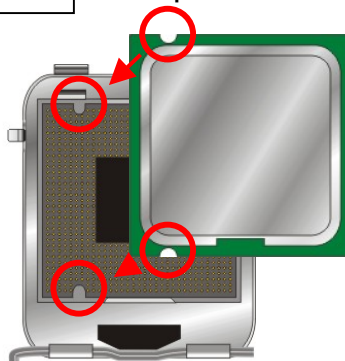

3. Place the CPU on the top of the pins



4. Lock this bar

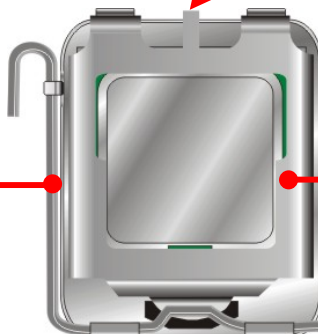

3. Cover this plate

Notice: Please place the CPU on the pins tenderly to avoid bending the pins

2.4.2 <Memory installation>

2807770 has four 240-pin DDR2 DIMM support up to 8GB of memory capacity. The memory frequency supports 533/667/800 MHz. Only Non-ECC memory is supported. **Dual-Channel technology** is supported while applying two modules with A+B channel.

DDRII B2
DDRII B1
DDRII A2
DDRII A1

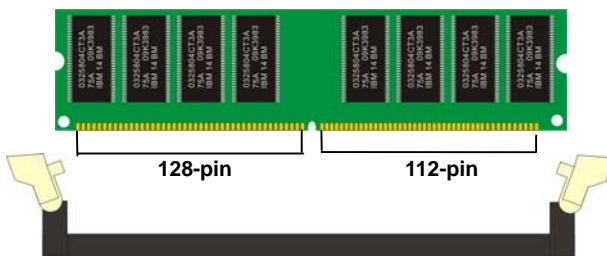
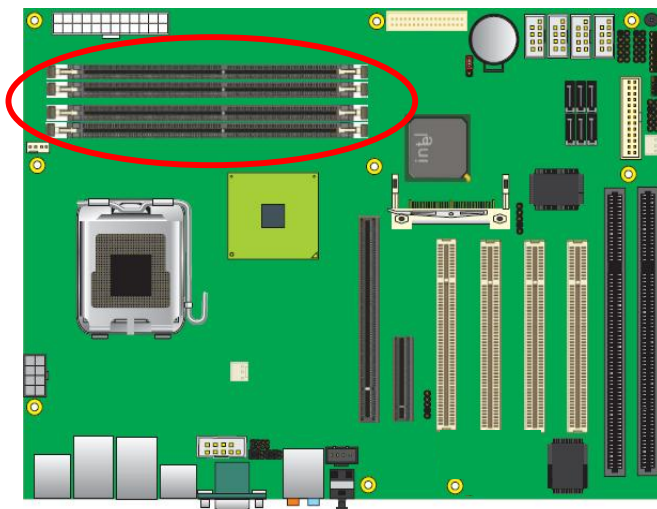

Please check the pin number to match the socket side well before installing memory module.

2.5 <CMOS Setup>

The board's data of CMOS can be setting in BIOS. If the board refuses to boot due to inappropriate CMOS settings, here is how to proceed to clear (reset) the CMOS to its default values.

Jumper: JRTC

Type: Onboard 3-pin jumper

JRTC	Mode
1-2	Clear CMOS
2-3	Normal Operation

Default setting

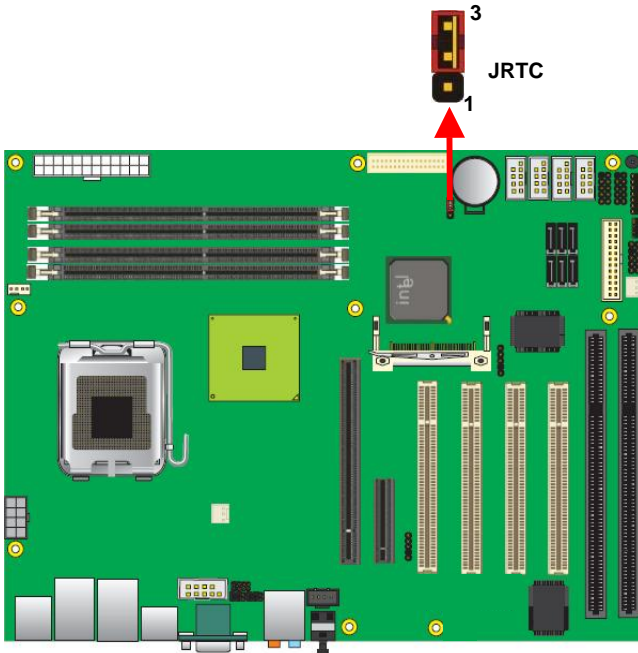

2.6 <Serial ATA installation>

2807770 has six Serial ATA II interfaces with RAID function, the transfer rate of the Serial ATA II can be up to 300MB/s. Please go to <http://www.serialata.org/> for more about Serial ATA technology information. Based on Intel® ICH8DO, it supports **Intel® Matrix Storage Technology** with combination of RAID 0,1,5 and 10. The main features of RAID on ICH8DO are listed below:

1. Supports for up to RAID volumes on a single, two-hard drive RAID array.
2. Supports for two, six-hard drive RAID arrays on any of six Serial ATA ports.
3. Supports for Serial ATA ATAPI devices.
4. Supports for RAID spares and automatic rebuild.
5. Supports on RAID arrays, including NCQ and native hot plug.

For more information please visit Intel's official website.

For more about the system setup for Serial ATA, please check the chapter of SATA configuration.

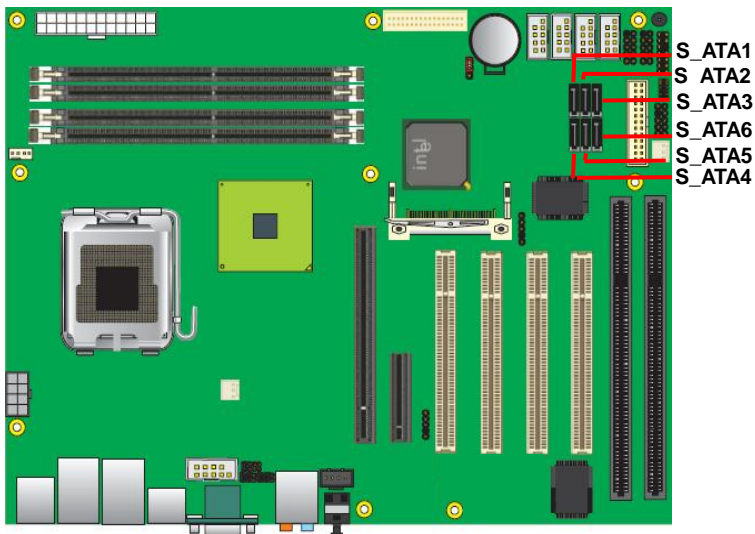

(Associate accessory)

2.7 <Floppy Installation>

2807770 has one 34-pin floppy interface, it supports use floppy and powering from onboard, please follow up the steps below to install the device.

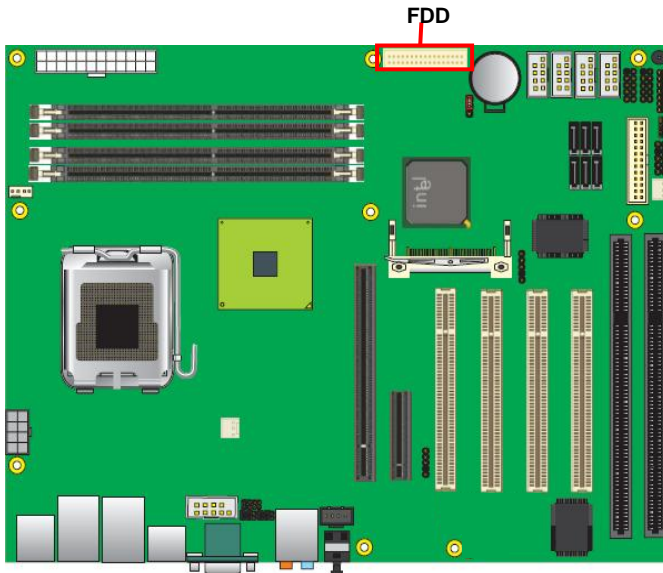

2.8 <LAN installation>

2807770 integrates two Gigabit LAN interfaces with Dual Intel 82573L; they provide a standard IEEE 802.3 Ethernet interface for 1000BASE-T, 100BASE-TX and 10BASE-T applications. **2807770** provides two RJ45 connectors on the rear I/O panel.

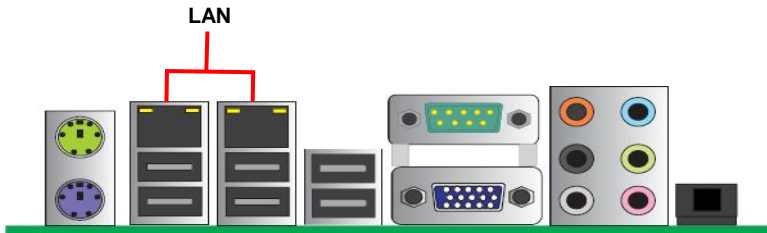

2.9 <Audio Installation>

The board integrates onboard audio interface with REALTEK ALC888 codec, with Intel next generation of audio standard as High Definition Audio, it offers more vivid sound and other advantages than former AC97 audio compliance.

The main specifications of ALC888 are:

- High-performance DACs with 97dB S/N ratio
- 10 DAC channels support 16/20/24-bit PCM format for 7.1 audio solution
- 16/20/24-bit S/PDIF-OUT supports 44.1K/48K/96K/192KHz sample rate

The board provides 7.1 channels audio phone jacks on rear I/O port, and Line-in/MIC-in ports for front I/O panel through optional cable.

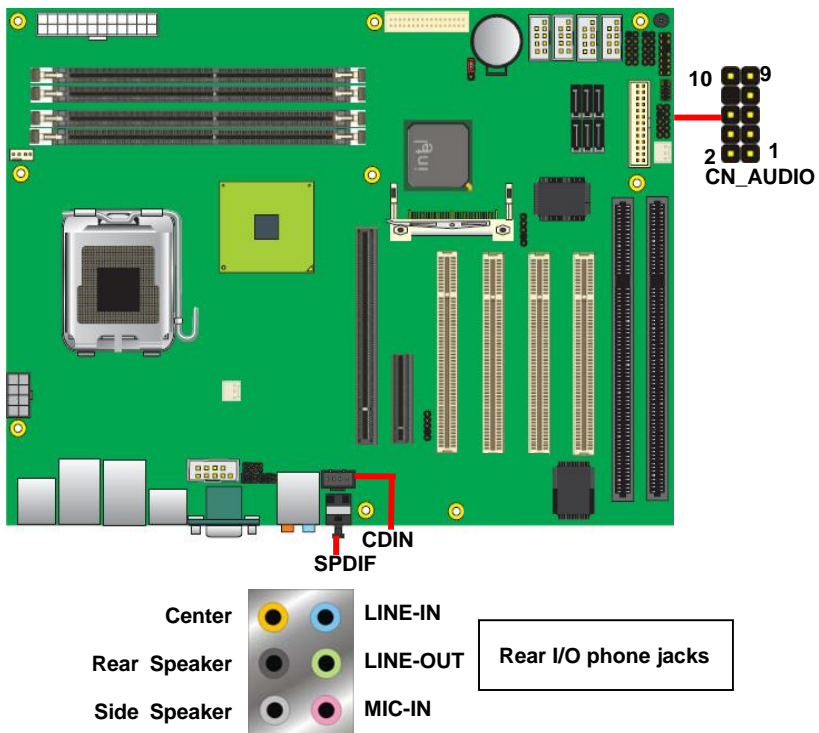

Connector: CN_AUDIO

Type: 10-pin (2 x 5) header (pitch = 2.54mm)

Pin	Description	Pin	Description
1	MIC_L	2	Ground
3	MIC_R	4	ACZ_DET
5	Front_R	6	MIC_JD
7	Sense	8	N/C
9	Front_L	10	Line_JD

Connector: CDIN

Type: 4-pin header (pitch = 2.54mm)

Pin	Description
1	CD – Left
2	Ground
3	Ground
4	CD – Right

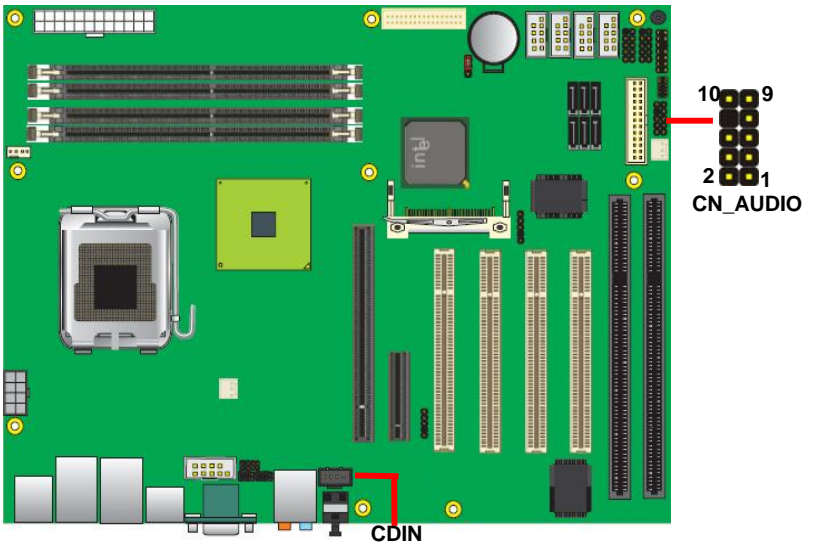

2.10 <Display Installation>

2807770 integrates with Intel® Q965 GMCH for Intel Graphic Media Accelerator (GMA) 3000 technology. It supports Intel® DVMT (Dynamic Video Memory Technology) 3.0 for up to 256MB frame buffer size shared with system memory. With a 400MHz core and DirectX 9 and OpenGL acceleration, **2807770** provides the powerful onboard graphics interface without additional graphic card. *(More information please visit Intel's website)*

For more information of configuring the frame buffer size, please check the chapter of video memory configuration.

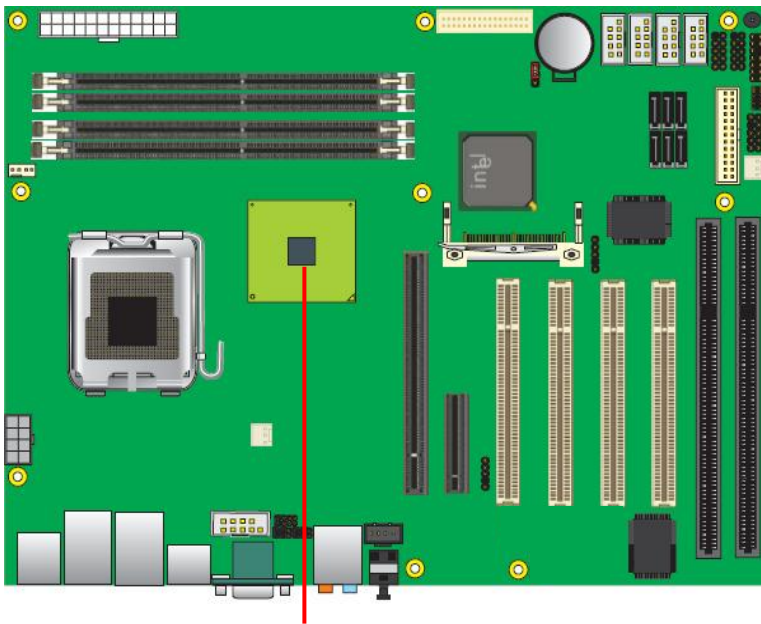

Intel Q965 GMCH



VGA (DB15)

2.11 <USB Installation>

2807770 integrates 10 USB2.0 ports. The specifications USB2.0 are listed below:

Interface	USB2.0
Controller	Intel ICH8DO
Transfer Rate	Up to 480Mb/s

The Intel® ICH8DO contains an Enhanced Host Controller Interface (EHCI) and six Universal Host Controller Interfaces (UHCI), it can determine whether your connected device is for USB1.1 or USB2.0, and change the transfer rate automatically.

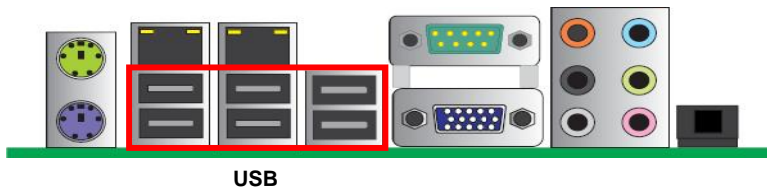

Connector: **CN_USB1/2**

Type: 10-pin (5 x 2) header for USB1/2 Ports

Pin	Description	Pin	Description
1	VCC	2	VCC
3	Data0-	4	Data1-
5	Data0+	6	Data1+
7	Ground	8	Ground
9	Ground	10	N/C

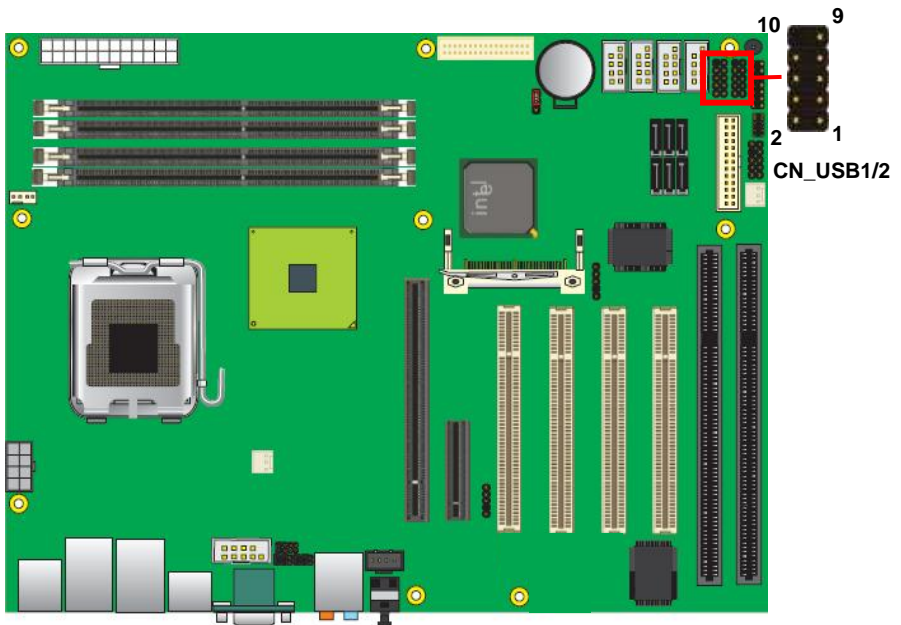

2.12 <Power and Fan Installation>

The **2807770** provides a standard ATX power supply with **24-pin** ATX connector and additional 12V connector, and the board provides one **4-pin** fan connectors supporting smart fan for CPU cooler and two 3-pin cooler fan connectors for system and Northbridge chip. The 8-pin additional power connector is necessary for CPU powering; please connect this well before you finishing the system setup.

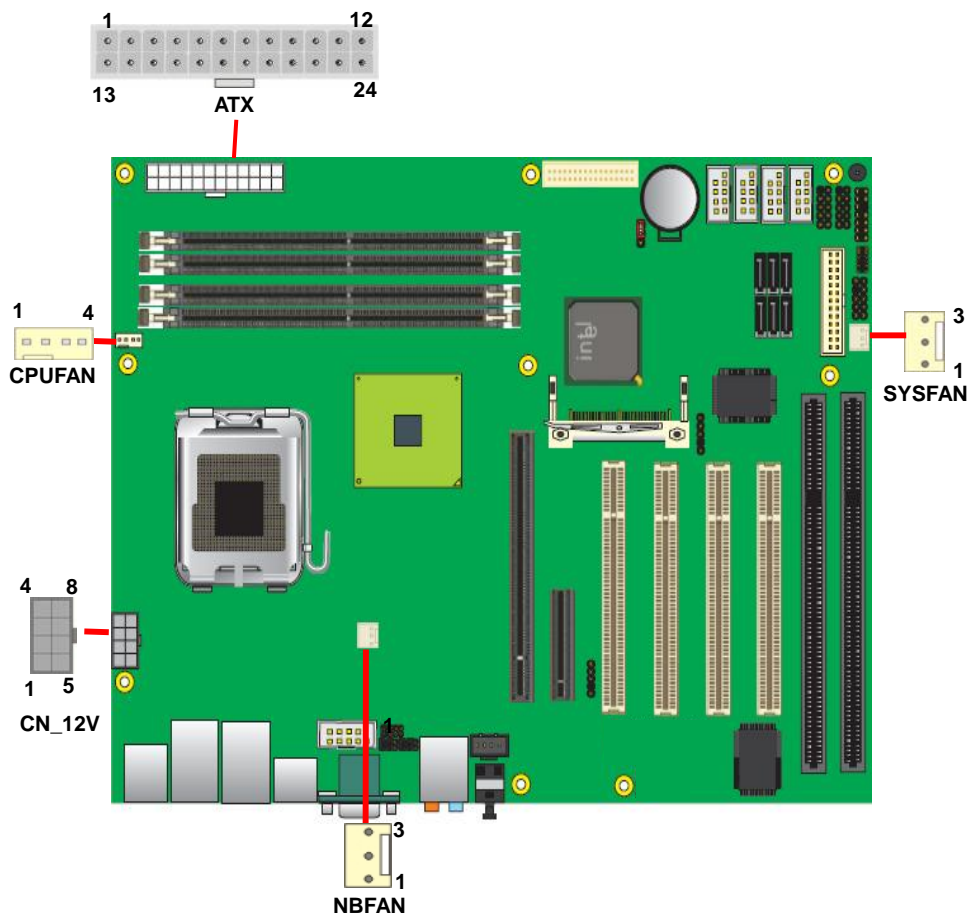

Connector: **ATX**

Type: 24-pin ATX power connector

PIN assignment			
1	3.3V	13	3.3V
2	3.3V	14	-12V
3	GND	15	GND
4	5V	16	PS_ON
5	GND	17	GND
6	5V	18	GND
7	GND	19	GND
8	PW_OK	20	-5V
9	5V_SB	21	5V
10	12V	22	5V
11	12V	23	5V
12	3.3V	24	GND

Connector: **CN_12V**

Type: 8-pin standard Pentium 4 additional +12V power connector

Pin	Description	Pin	Description
1	Ground	5	+12V
2	Ground	6	+12V
3	Ground	7	+12V
4	Ground	8	+12V

Connector: **CPUFAN**

Type: 4-pin fan wafer connector

Pin	Description	Pin	Description
1	Ground	2	+12V
3	Fan Speed Detection	4	Sense

Connector: **NBFAN, SYSFAN**

Type: 3-pin fan wafer connector

Pin	Description	Pin	Description	Pin	Description
1	Ground	2	+12V	3	Sense

2.13 <GPIO & SMBUS interface>

The board provides a programmable 8-bit digital I/O interface, and one SMBus (System management bus) interface for control panel application.

Connector: **CN_DIO**

Type: onboard 2 x 6-pin header, pitch=2.0mm

Pin	Description	Pin	Description
1	Ground	2	Ground
3	GP10	4	GP14
5	GP11	6	GP15
7	GP12	8	GP16
9	GP13	10	GP17
11	VCC	12	+12V

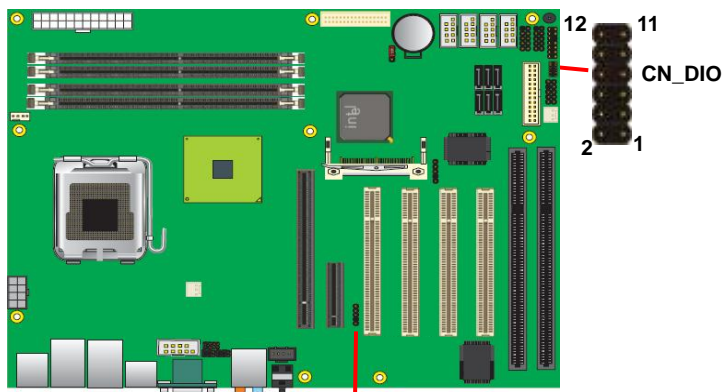

Connector: **CN_SMBUS**

Type: 5-pin 2.54-pitch header

Pin	Description
1	VCC
2	N/C
3	SMBDATA
4	SMBCLK
5	Ground

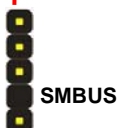

2.14 <Serial Port>

The board supports one RS232 serial port and one jumper selectable RS232/422/485 serial ports. The jumper JCSEL1 & JCSEL2 can let you configure the communicating modes for COM2.

Connector: **CN_COM2**

Type: 10-pin (5 x 2) 2.54mm x 2.54mm-pitch box header for COM2

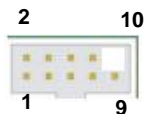

Pin	Description	Pin	Description
1	DCD/422RX-/485-	2	RXD/422RX+/485+
3	TXD/422TX+	4	DTR/422TX-
5	GND	6	DSR
7	RTS	8	CTS
9	RI	10	N/C

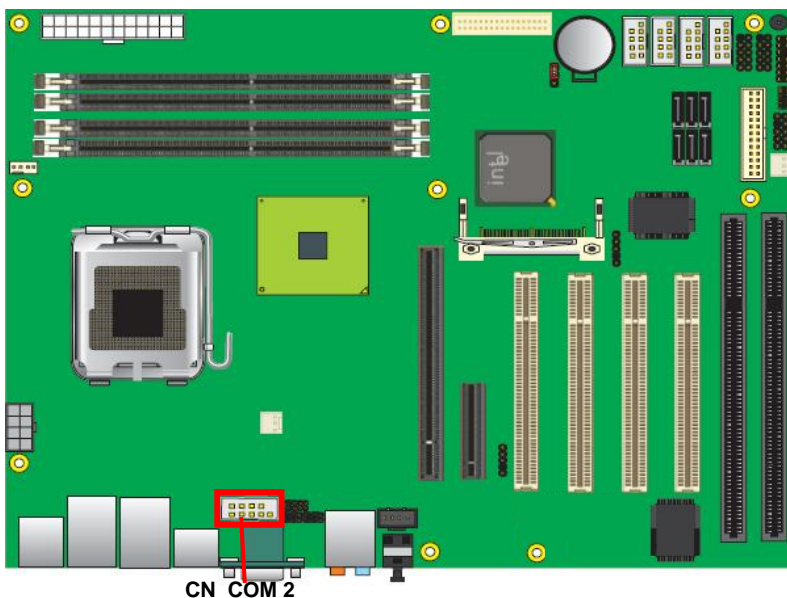

	JCSEL1	JCSEL2
SIR		
RS-422		
RS-485		
RS-232		

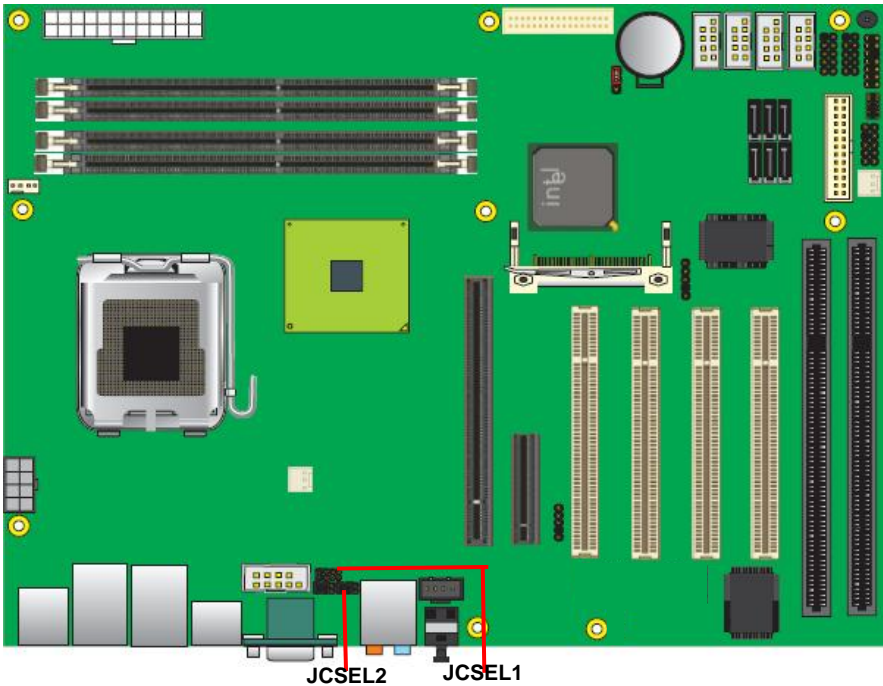

2.15 <Switch & Indicator>

The **JFRNT** provides front control panel of the board, such as power button, reset and beeper, etc. Please check well before you connecting the cables on the chassis.

Connector: **JFRNT**

Type: onboard 14-pin (2 x 7) 2.54-pitch header

Function	Signal	PIN		Signal	Function
IDE LED	HDLED+	1	2	PWDLED+	Power LED
	HDLED-	3	4	N/C	
Reset	Reset+	5	6	PWDLED-	Speaker
	Reset-	7	8	SPKIN+	
N/C		9	10	N/C	
Power Button	PWRBT+	11	12	N/C	
	PWRBT-	13	14	SPKIN-	

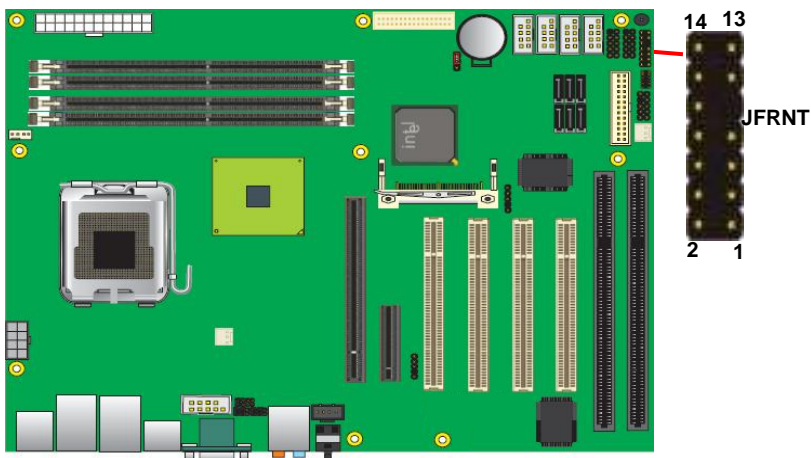

2.16 <Expansion Interface>

2807770 has one x16 and x4 PCI-Express slot. PCI-Express is the last expansion interface technology, for its serial data transfer scheme, each lane will be up to 500MB/s (duplex), and the x16 (16 lanes) can be up to 8GB/s more than 2GB/s as AGP 8x bus transfer rate. The x4 slot can be also for x1 compatible use.

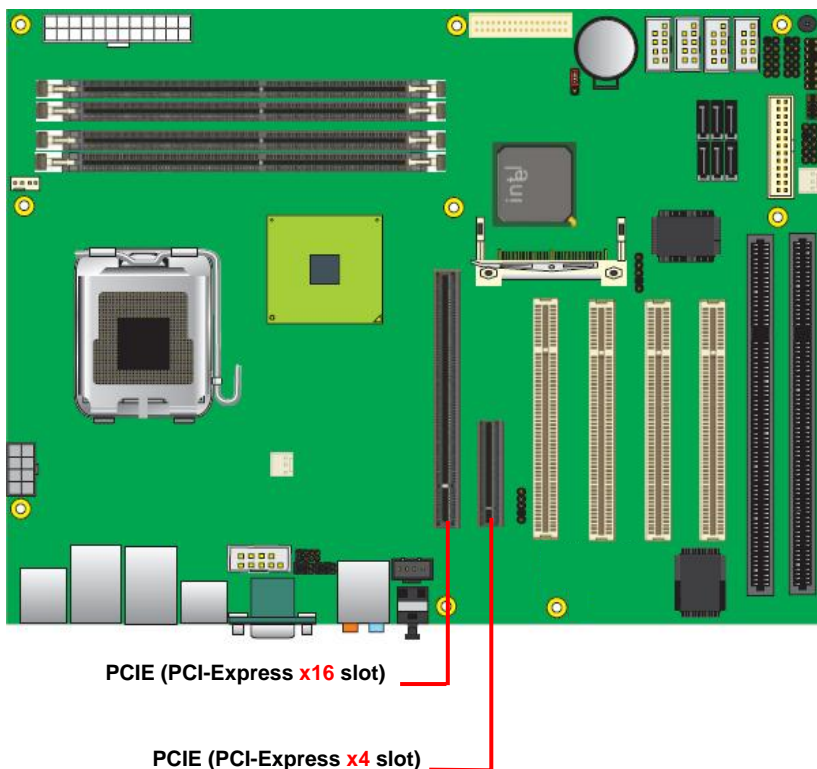

(This page is left for blank)

Chapter 3 <System Configuration>

3.1 <SATA configuration>

SATA Mode:



This option can let you select whether the Serial ATA hard drives would work under normal IDE mode or RAID mode. The RAID mode need more than one HDD is applied.

3.2 <SATA RAID Configuration>

The board integrates Intel® ICH8DO with RAID function for Serial ATA II drives, and supports the configurations below:

RAID 0 (Striping): Two hard drives operating as one drive for optimized data R/W performance. It needs two unused drives to build this operation.

RAID 1 (Mirroring): Copies the data from first drive to second drive for data security, and if one drive fails, the system would access the applications to the workable drive. It needs two unused drives or one used and one unused drive to build this operation. The second drive must be the same or larger size than first one.

RAID 5 (striping with parity)

A RAID 5 array contains three or more hard drives where the data is divided into manageable blocks called strips. Parity is a mathematical method for recreating data that was lost from a single drive, which increases fault-tolerance. The data and parity are striped across all the hard drives in the array. The parity is striped in a rotating sequence to reduce bottlenecks associated with the parity calculations.

RAID 10 (RAID 0+1)

A RAID 10 array uses four hard drives to create a combination of RAID levels 0 and 1. The data is striped across a two-drive array forming the RAID 0 component. Each of the drives in the RAID 0 array is then mirrored by a RAID 1 component.

Intel Matrix Storage Technology: This technology would allow you to use **RAID 0+1** mode on only two drives (4 drives needed on traditional RAID 0+1). It will create two partitions on each hard drive to simulate **RAID 0** and **RAID 1**. It also can let you modify the partition size without re-formatted.

For more information of Intel Matrix Storage Technology, please visit Intel's website.

If you need to install an operation system on the RAID set, please use the driver disk attached in the package when it informs you to obtain the RAID drivers.

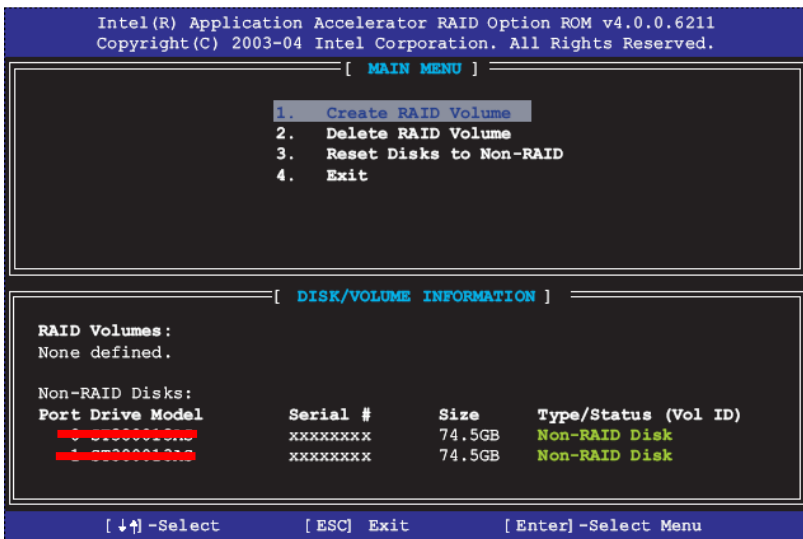

Please press <CTRL+I> to enter the RAID configuration menu.

You can setup the RAID under operation system for Microsoft® Windows XP SP1 or Windows 2000 SP4 version, please install the Intel® Application Accelerator Ver.4.5 later to support RAID configuration with Intel® Matrix Storage Technology.

1. After installing Intel Application Accelerator, please execute Intel® Storage Utility.

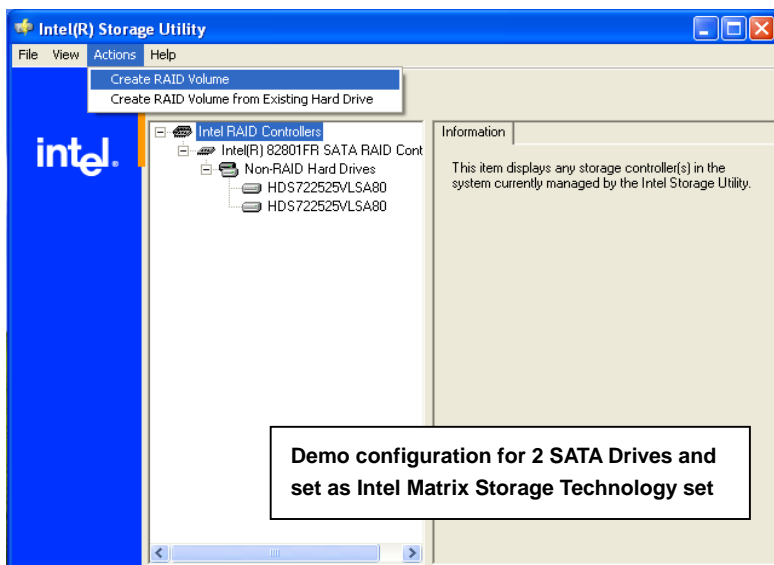

2. Select Actions to Create RAID Volume

Rename the Volume name —

Select RAID Level as 0 —

Left as default —

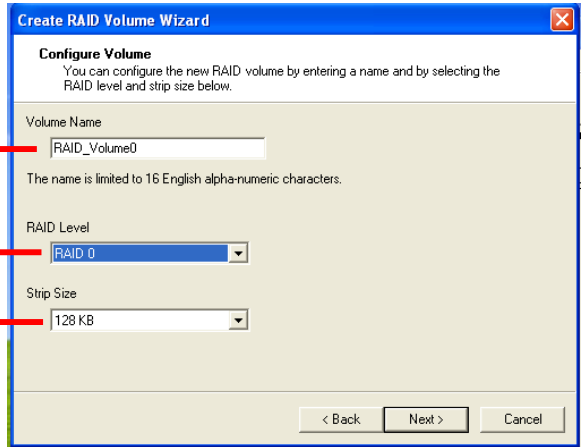

3. Please select two hard drives to prepare to set the RAID volume

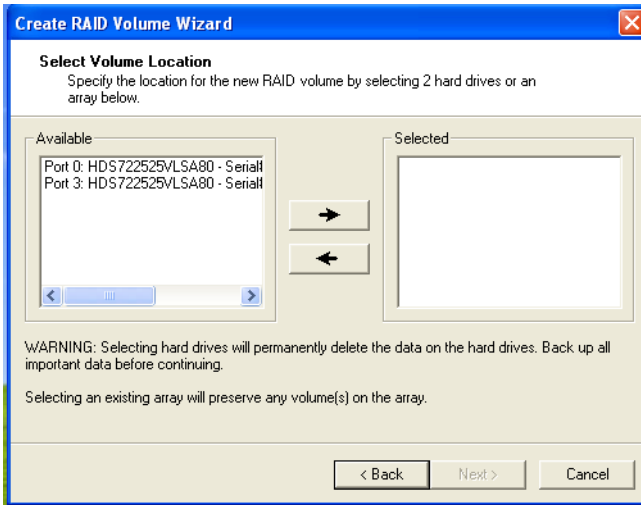

4. Specify the Volume size

Tune this bar to specify the volume size, if you specify the volume size lower than maximum, you can create a second volume for another RAID set. (Make RAID 0+1 on only two hard drives)

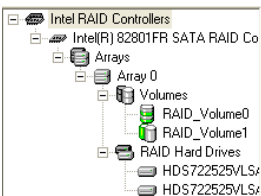
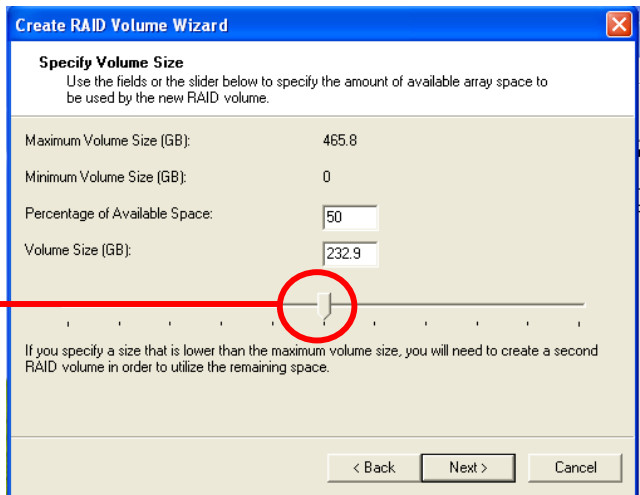

5. Repeat the step 1 to create second volume as RAID Level 1.

For other configuration set please click Help on tool bar.

3.3 <Audio Configuration>

The board integrates Intel® ICH8DO with REALTEK® ALC888codec. It can support 7.1channel sound under system configuration. Please follow the steps below to setup your sound system.

1. Install REALTEK AC97 Audio driver.



2. Launch the control panel and Sound Effect Manager.
3. Select Speaker Configuration



4. Select the sound mode to meet your speaker system.

3.4 <Video Memory Setup>

Based on Intel® Q965 chipset with GMA (Graphic Media Accelerator) 3000, the board supports Intel® DVMT (Dynamic Video Memory Technology) 3.0, which would allow the video memory be triggered up to 256MB.

To support DVMT, you need to install the Intel GMA 3000 Driver with supported OS.

BIOS Setup:

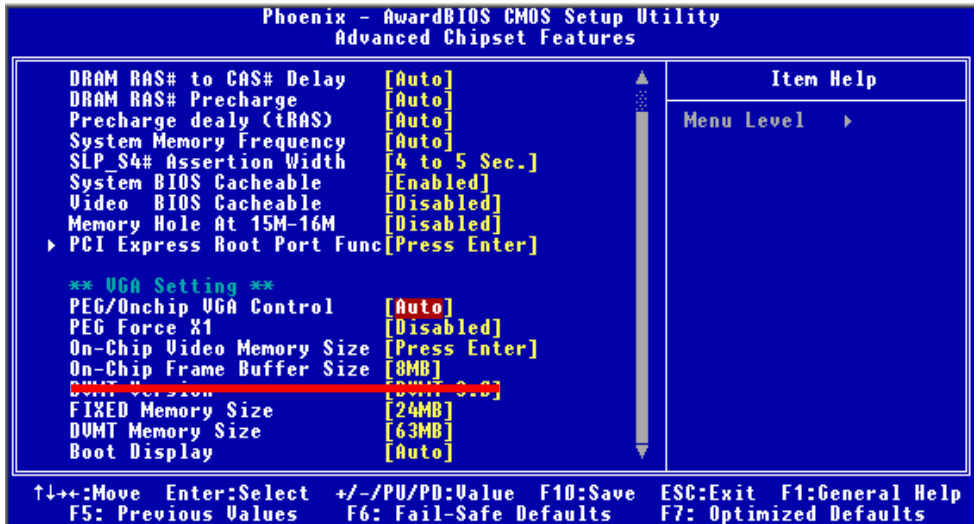

On-Chip Video Memory Size: This option combines three items below for setup.

On-Chip Frame Buffer Size:

This item can let you select video memory which been allocated for legacy VGA and SVGA graphics support and compatibility. The available option is **1MB** and **8MB**.

Fixed Memory Size:

This item can let you select a static amount of page-locked graphics memory which will be allocated during driver initialization. Once you select the memory amount, it will be no longer available for system memory.

DVMT Memory Size:

This item can let you select a maximum size of dynamic amount usage of video memory, the system would configure the video memory depends on your application, this item is

strongly recommend to be selected as **MAX DVMT**.

Fixed + DVMT Memory Size:

You can select the fixed amount and the DVMT amount at the same time for a guaranteed video memory and additional dynamic video memory, please check the table below for available setting.

System Memory	On-Chip Frame Buffer Size	Fixed Memory Size	DVMT Memory Size	Total Graphic Memory
256MB ~ 511MB	1MB	128MB	0MB	128MB
	1MB	0MB	128MB	128MB
	8MB	128MB	0MB	128MB
	8MB	0	128MB	128MB
512MB~1023MB	1MB	128MB	0	128MB
	1MB	256MB	0	256MB
	1MB	0	128MB	128MB
	1MB	0	256MB	256MB
	8MB	128MB	0	128MB
	8MB	256MB	0	256MB
	8MB	0	128MB	128MB
	8MB	0	256MB	256MB

Notice:

1. The On-Chip Frame Buffer Size would be included in the Fixed Memory.

Please select the memory size according to this table

(This page is left for blank)

(This page is left for blank)

Appendix A <I/O Port Pin Assignment>

A.1 <Floppy Port>

Connector: FDD

Type: 34-pin (2 x 17) 2.54-pitch box header

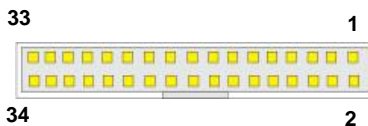

Pin	Description	Pin	Description
1	Ground	2	DRIVE DENSITY SELECT 0
3	Ground	4	DRIVE DENSITY SELECT 1
5	Ground	6	N/C
7	Ground	8	INDEX-
9	Ground	10	MOTOR ENABLE A-
11	Ground	12	DRIVER SELECT B-
13	Ground	14	DRIVER SELECT A-
15	Ground	16	MOTOR ENABLE B-
17	Ground	18	DIRECTION-
19	Ground	20	STEP-
21	Ground	22	WRITE DATA-
23	Ground	24	WRITE GATE-
25	Ground	26	TRACK 0-
27	Ground	28	WRITE PROTECT-
29	Ground	30	READ DATA-
31	Ground	32	HEAD SELECT-
33	Ground	34	DISK CHANGE-

A.2 <Serial Port>

Connector: **COM1**

Type: 9-pin D-sub male connector on I/O Panel

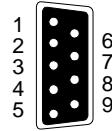

Pin	Description	Pin	Description
1	DCD	6	DSR
2	SIN	7	RTS
3	SO	8	CTS
4	DTR	9	RI
5	Ground		

Connector: **COM2/3/4/5/6**

Type: 10-pin (2x5) 2.54-pitch box header

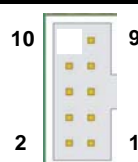

Pin	Description	Pin	Description
1	DCD-	6	DSR-
2	SIN-	7	RTS-
3	SO-	8	CTS-
4	DTR-	9	RI
5	Ground	10	N/C

A.3 <VGA Port>

Connector: **VGA**

Type: 15-pin D-sub female connector on I/O Panel

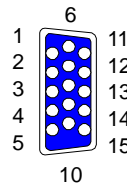

Pin	Description	Pin	Description	Pin	Description
1	RED	6	Ground	11	N/C
2	GREEN	7	Ground	12	5VCDA
3	BLUE	8	Ground	13	HSYNC
4	N/C	9	LVGA5V	14	VSYNC
5	Ground	10	Ground	15	5VCLK

A.4 <LAN Port>

Connector: **RJ45**

Type: RJ45 connector with LED on I/O Panel



Pin	1	2	3	4	5
Description	TRD0+	TRD0-	TRD1+	TRD1-	NC

Pin	6	7	8	9	10
Description	NC	TRD2+	TRD2-	TRD3+	TRD3-

A.5 <SMBus>

Connector: **CN_SMBUS**

Type: 5-pin SMBus (1x5)2.54 pitch header

Pin	Description	Pin	Description
1	VCC	2	N/C
3	SMBDATA	4	SMBCLK
5	Ground		

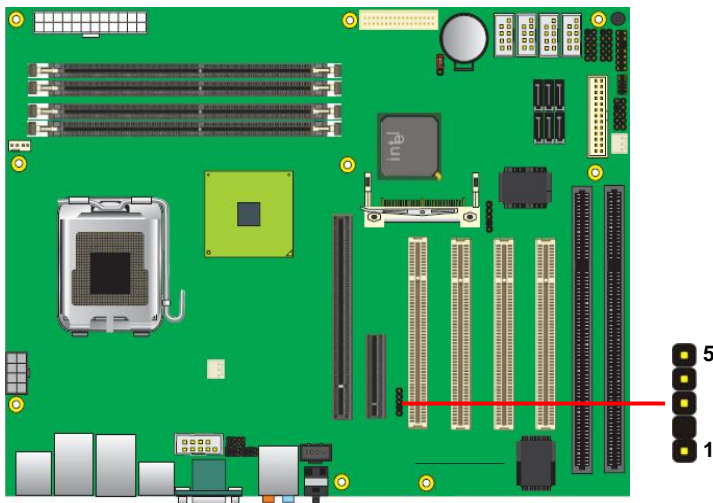

A.6 <Parallel Port>

Connector: **LPT (PRINTER)**

Type: 26-pin (2 x 13) 2.54-pitch box header

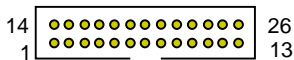

Pin	Description	Pin	Description
1	STROBE-	14	AUTO FEED-
2	D0	15	ERROR-
3	D1	16	INITIALIZE-
4	D2	17	SELECT INPUT-
5	D3	18	Ground
6	D4	19	Ground
7	D5	20	Ground
8	D6	21	Ground
9	D7	22	Ground
10	ACKNOWLEDGE-	23	Ground
11	BUSY	24	Ground
12	PAPER EMPTY	25	Ground
13	SELECT+	26	N/C

A.7 <IrDA Port>

Connector: **CN_IR**

Type: 5-pin header for SIR Port



Pin	Description
1	Vcc
2	N/C
3	IRRX
4	Ground
5	IRTX

Appendix B <System Resources>

B1. <I/O Port Address Map>

[00000000 - 0000000F]	Direct memory access controller
[00000000 - 00000CF7]	PCI bus
[00000010 - 0000001F]	Motherboard resources
[00000020 - 00000021]	Programmable interrupt controller
[00000022 - 0000003F]	Motherboard resources
[00000040 - 00000043]	System timer
[00000044 - 0000005F]	Motherboard resources
[00000060 - 00000060]	Standard 101/102-Key or Microsoft Natural PS/2 Keyboard
[00000061 - 00000061]	System speaker
[00000062 - 00000063]	Motherboard resources
[00000064 - 00000064]	Standard 101/102-Key or Microsoft Natural PS/2 Keyboard
[00000065 - 0000006F]	Motherboard resources
[00000070 - 00000073]	System CMOS/real time clock
[00000074 - 0000007F]	Motherboard resources
[00000080 - 00000090]	Direct memory access controller
[00000091 - 00000093]	Motherboard resources
[00000094 - 0000009F]	Direct memory access controller
[000000A0 - 000000A1]	Programmable interrupt controller
[000000A2 - 000000BF]	Motherboard resources
[000000C0 - 000000DF]	Direct memory access controller
[000000E0 - 000000EF]	Motherboard resources
[000000F0 - 000000FF]	Numeric data processor
[00000274 - 00000277]	ISAPNP Read Data Port
[00000279 - 00000279]	ISAPNP Read Data Port
[000002F8 - 000002FF]	Communications Port (COM2)
[00000378 - 0000037F]	Printer Port (LPT1)
[000003B0 - 000003BB]	Intel(R) Q965/Q963 Express Chipset Family
[000003C0 - 000003DF]	Intel(R) Q965/Q963 Express Chipset Family
[000003E8 - 000003EF]	Communications Port (COM3)
[000003F0 - 000003F5]	Standard floppy disk controller
[000003F7 - 000003F7]	Standard floppy disk controller
[000003F8 - 000003FF]	Communications Port (COM1)
[00000400 - 000004BF]	Motherboard resources
[00000880 - 0000088F]	Motherboard resources

[0000A79 - 0000A79]	ISAPNP Read Data Port
[0000D00 - 0000FFFF]	PCI bus
[00009000 - 00009FFF]	Intel(R) ICH8 Family PCI Express Root Port 1 - 283F
[0000A000 - 0000AFFF]	Intel(R) Q963/Q965 PCI Express Root Port - 2991
[0000B000 - 0000BFFF]	Intel(R) ICH8 Family PCI Express Root Port 6 - 2849
[0000BF00 - 0000BF1F]	Intel(R) PRO/1000 PL Network Connection
[0000D000 - 0000DFFF]	Intel(R) ICH8 Family PCI Express Root Port 5 - 2847
[0000DF00 - 0000DF1F]	Intel(R) PRO/1000 PL Network Connection #2
[0000ED00 - 0000ED0F]	Intel(R) ICH8 2 port Serial ATA Storage Controller - 2825
[0000EE00 - 0000EE0F]	Intel(R) ICH8 2 port Serial ATA Storage Controller - 2825
[0000EF00 - 0000EF03]	Intel(R) ICH8 2 port Serial ATA Storage Controller - 2825
[0000F000 - 0000F007]	Intel(R) ICH8 2 port Serial ATA Storage Controller - 2825
[0000F100 - 0000F103]	Intel(R) ICH8 2 port Serial ATA Storage Controller - 2825
[0000F200 - 0000F207]	Intel(R) ICH8 2 port Serial ATA Storage Controller - 2825
[0000F400 - 0000F40F]	Intel(R) ICH8 4 port Serial ATA Storage Controller - 2820
[0000F500 - 0000F50F]	Intel(R) ICH8 4 port Serial ATA Storage Controller - 2820
[0000F600 - 0000F603]	Intel(R) ICH8 4 port Serial ATA Storage Controller - 2820
[0000F700 - 0000F707]	Intel(R) ICH8 4 port Serial ATA Storage Controller - 2820
[0000F800 - 0000F803]	Intel(R) ICH8 4 port Serial ATA Storage Controller - 2820
[0000F900 - 0000F907]	Intel(R) ICH8 4 port Serial ATA Storage Controller - 2820
[0000FA00 - 0000FA1F]	Intel(R) ICH8 Family USB Universal Host Controller - 2832
[0000FB00 - 0000FB1F]	Intel(R) ICH8 Family USB Universal Host Controller - 2831
[0000FC00 - 0000FC1F]	Intel(R) ICH8 Family USB Universal Host Controller - 2830
[0000FD00 - 0000FD1F]	Intel(R) ICH8 Family USB Universal Host Controller - 2835
[0000FE00 - 0000FE1F]	Intel(R) ICH8 Family USB Universal Host Controller - 2834
[0000FF00 - 0000FF07]	Intel(R) Q965/Q963 Express Chipset Family
[0000FFFF - 00010006]	Communications Port (COM4)
[0000FFFF - 00010006]	Communications Port (COM5)
[0000FFFF - 00010006]	Communications Port (COM6)

B2. <Memory Address Map>

[00000000 - 0009FFFF]	System board
[000A0000 - 000BFFFF]	Intel(R) Q965/Q963 Express Chipset Family
[000A0000 - 000BFFFF]	PCI bus
[000C0000 - 000DFFFF]	PCI bus
[000E0000 - 000EFFFF]	System board
[000F0000 - 000FFFFF]	System board
[00100000 - CF6DFFFF]	System board
[CF6E0000 - CF6FFFFF]	System board
[CF700000 - CF7FFFFF]	System board
[CF750000 - FEBFFFFF]	PCI bus
[D0000000 - DFFFFFFF]	Intel(R) Q965/Q963 Express Chipset Family
[E0000000 - EFFFFFFF]	Motherboard resources
[FD400000 - FD4FFFFF]	Intel(R) Q963/Q965 PCI Express Root Port - 2991
[FD500000 - FD5FFFFF]	Intel(R) Q963/Q965 PCI Express Root Port - 2991
[FD800000 - FD8FFFFF]	Intel(R) Q965/Q963 Express Chipset Family
[FD900000 - FD9FFFFF]	Intel(R) ICH8 Family PCI Express Root Port 6 - 2849
[FDA00000 - FDAFFFFF]	Intel(R) ICH8 Family PCI Express Root Port 6 - 2849
[FDAE0000 - FDAFFFFF]	Intel(R) PRO/1000 PL Network Connection
[FDB00000 - FDBFFFFF]	Intel(R) ICH8 Family PCI Express Root Port 5 - 2847
[FDC00000 - FDCFFFFF]	Intel(R) ICH8 Family PCI Express Root Port 5 - 2847
[FDCE0000 - FDCFFFFF]	Intel(R) PRO/1000 PL Network Connection #2
[FDD00000 - FDDFFFFF]	Intel(R) ICH8 Family PCI Express Root Port 1 - 283F
[FDE00000 - FDEFFFFF]	Intel(R) ICH8 Family PCI Express Root Port 1 - 283F
[FDFF8000 - FDFFBFFF]	Microsoft UAA Bus Driver for High Definition Audio
[FDFFD000 - FDFFDFFF]	Intel(R) ICH8 Family SMBus Controller - 283E
[FDFFE000 - FDFFE3FF]	Intel(R) ICH8 Family USB2 Enhanced Host Controller - 2836
[FDFFF000 - FDFFF3FF]	Intel(R) ICH8 Family USB2 Enhanced Host Controller - 283A
[FEC00000 - FEC0FFFF]	System board
[FED13000 - FED1FFFF]	System board
[FED20000 - FED9FFFF]	System board
[FEE00000 - FEE0FFFF]	System board
[FFB00000 - FFB7FFFF]	System board
[FFB80000 - FFBFFFFF]	Intel(R) 82802 Firmware Hub Device
[FFF00000 - FFFFFFFF]	System board

B3. <System IRQ Resources>

IRQ :

(ISA) 0	System timer
(ISA) 1	Standard 101/102-Key or Microsoft Natural PS/2 Keyboard
(ISA) 3	Communications Port (COM2)
(ISA) 4	Communications Port (COM1)
(ISA) 5	Communications Port (COM3)
(ISA) 6	Standard floppy disk controller
(ISA) 8	System CMOS/real time clock
(ISA) 9	Microsoft ACPI-Compliant System
(ISA) 12	PS/2 Compatible Mouse
(ISA) 13	Numeric data processor
(PCI) 15	Intel(R) ICH8 Family SMBus Controller - 283E
(PCI) 16	Intel(R) Q965/Q963 Express Chipset Family
(PCI) 16	Intel(R) ICH8 Family PCI Express Root Port 1 - 283F
(PCI) 16	Intel(R) ICH8 Family PCI Express Root Port 5 - 2847
(PCI) 16	Intel(R) ICH8 Family USB Universal Host Controller - 2834
(PCI) 16	Intel(R) PRO/1000 PL Network Connection #2
(PCI) 16	Intel(R) Q963/Q965 PCI Express Root Port - 2991
(PCI) 17	Intel(R) ICH8 Family PCI Express Root Port 6 - 2849
(PCI) 17	Intel(R) PRO/1000 PL Network Connection
(PCI) 18	Intel(R) ICH8 Family USB Universal Host Controller - 2832
(PCI) 18	Intel(R) ICH8 Family USB2 Enhanced Host Controller - 283A
(PCI) 19	Intel(R) ICH8 2 port Serial ATA Storage Controller - 2825
(PCI) 19	Intel(R) ICH8 4 port Serial ATA Storage Controller - 2820
(PCI) 19	Intel(R) ICH8 Family USB Universal Host Controller - 2831
(PCI) 21	Intel(R) ICH8 Family USB Universal Host Controller - 2835
(PCI) 22	Microsoft UAA Bus Driver for High Definition Audio
(PCI) 23	Intel(R) ICH8 Family USB Universal Host Controller - 2830
(PCI) 23	Intel(R) ICH8 Family USB2 Enhanced Host Controller - 2836

(This page is left for blank)

Appendix C <Programming GPIO's>

The GPIO can be programmed with the MSDOS debug program using simple IN/OUT commands. The following lines show an example how to do this.

```
GPIO0.....GPIO7  bit0.....bit7
-o 4E 87           ;enter configuration
-o 4E 87
-o 4E 07
-o 4F 09           ;enale GPIO function
-o 4E 30
-o 4F 02           ;enable GPIO configuration
-o 4E F0
-o 4F xx           ;set GPIO as input/output; set '1' for input,'0' for
output
-o 4E F1
-o 4F xx           ;if set GPIO's as output,in this register its value can
be set
```

Optional :

```
-o 4E F2
-o 4F xx           ; Data inversion register ; '1' inverts the current valus
of the bits ,'0' leaves them as they are
-o 4E 30
-o 4F 01           ; active GPIO's
```

For further information, please refer to Winbond W83627DHG datasheet.

Appendix D <Watch Dog timer Setting >

The watchdog timer makes the system auto-reset while it stops to work for a period. The integrated watchdog timer can be setup as system reset mode by program.

Timeout Value Range

- 1 to 255
- Second or Minute

Program Sample

Watchdog timer setup as system reset with 5 second of timeout

```

-O 4E, 87
-O 4E, 87
-O 4E, 07
-O 4F, 08      Logical Device 8
-O 4E, 30      Activate
-O 4F, 01
-O 4E, F5      Set as Second*
-O 4F, 00
-O 4E, F6      Set as 5
-O 4F, 05
    
```

* Minute: bit 3 = 0; Second: bit 3 = 1

You can select Timer setting in the BIOS, after setting the time options, the system will reset according to the period of your selection.

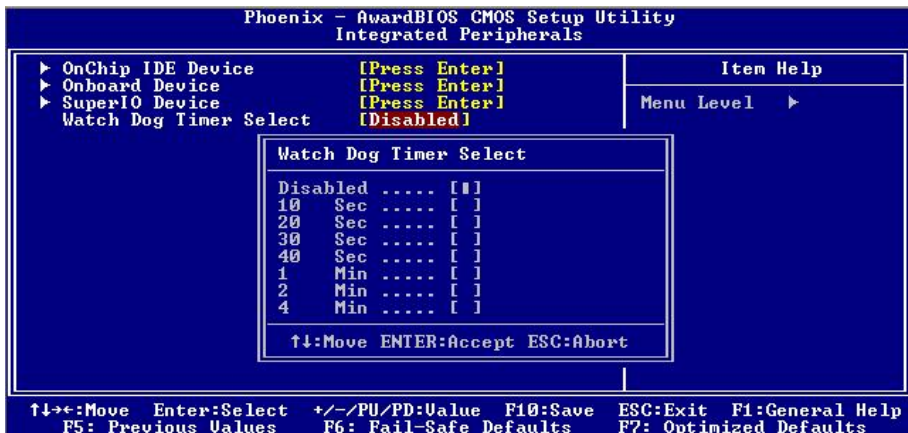

Any advice or comments about our products and service, or anything we can help you with please don't hesitate to contact with us. We will do our best to support your products, projects and business.



Address: Global American, Inc.
17 Hampshire Drive
Hudson, NH 03051

Telephone: Toll Free (U.S. Only) 800-833-8999
(603)886-3900

FAX: (603)886-4545

Website: <http://www.globalamericaninc.com>

E-Mail: salesinfo@globalamericaninc.com
