



2808160

Mini-ITX Motherboard

**User's Manual**

Edition 1.0

2009/01/19

---



## **Copyrights**

This manual is copyrighted and all rights are reserved. It does not allow any non authorization in copied, photocopied, translated or reproduced to any electronic or machine readable form in whole or in part without prior written consent from the manufacturer.

In general, the manufacturer will not be liable for any direct, indirect, special, incidental or consequential damages arising from the use of inability to use the product or documentation, even if advised of the possibility of such damages. The manufacturer keeps the rights in the subject to change the contents of this manual without prior notices in order to improve the function design, performance, quality and reliability. The author assumes no responsibility for any errors or omissions, which may appear in this manual, nor does it make a commitment to update the information contained herein.

## **Trademarks**

Intel is a registered trademark of Intel Corporation.

Award is a registered trademark of Award Software, Inc.

All other trademarks, products and or product's name mentioned herein are mentioned for identification purposes only, and may be trademarks and/or registered trademarks of their respective companies or owners.

Any questions please visit our website at <http://www.globalamericaninc.com>

## Packing List:

Please check the package content before you starting using the board.

### Hardware:

2808160 Mini-ITX Motherboard x 1

### Cable Kit:

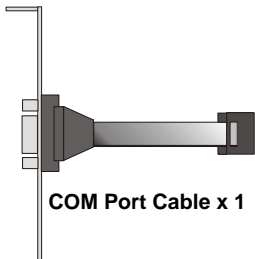

COM Port Cable x 1



SATA Cable x 1

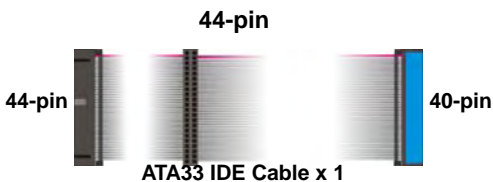

ATA33 IDE Cable x 1

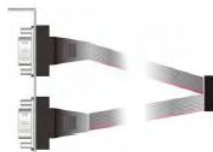

COM x 2 cable x 1  
(optional)

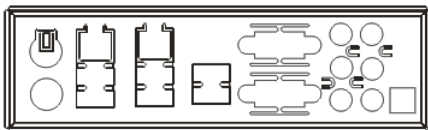

I/O Shield x 1

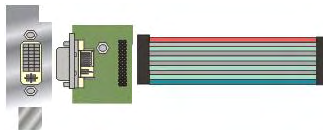

DVI module x 1 (optional)

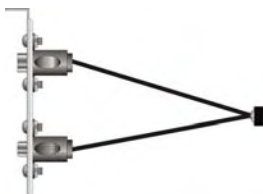

SDTV Cable x 1 (optional)

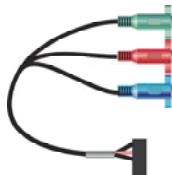

YPbPr Cable x 1 (optional)

### Printed Matters:

Driver CD (Including User's Manual) x 1

<b>Chapter 1 &lt;Introduction&gt;</b> .....	<b>6</b>
1.1 <Product Overview>.....	6
1.2 <Mechanical Drawing> .....	9
1.3 <Block Diagram> .....	10
<b>Chapter 2 &lt;Hardware Setup&gt;</b> .....	<b>11</b>
2.1 <Connector Location> .....	11
2.2 <Jumper Location & Reference>.....	12
2.3 <Connector Reference> .....	13
2.3.1 <Internal Connectors>.....	13
2.3.2 <External Connectors>.....	13
2.4 <Memory Setup> .....	14
2.5 <CMOS Setup> .....	15
2.6 <Enhanced IDE & CF Interface> .....	16
2.7 <Serial ATA Interface> .....	17
2.8 <Ethernet Interface> .....	18
2.9 <Onboard Display Interface> .....	19
2.9.1 <Analog Display> .....	19
2.9.2 <Digital Display>.....	20
2.9.3 <LVDS2 Interface 2808160C only >.....	21
2.9.4 <DVI Interface 2808160B only > .....	25
2.9.5 <HDTV Interface> .....	26
2.10 <Integrated Audio Interface>.....	27
2.11 <GPIO Interface & SMBUS>.....	29
2.12 <Serial Port>.....	30
2.13 <Power Supply> .....	32
2.13.1 <Power connector>.....	32
2.13.2 <Fan connector & JAT JUMPER> .....	33
2.14 <Switch and Indicator>.....	34

<b>Chapter 3 &lt;System Setup&gt;</b> .....	<b>35</b>
3.1 <Audio Configuration> .....	35
3.2 <Display Properties Setting> .....	36
<b>Chapter 4 &lt;BIOS Setup&gt;</b> .....	<b>38</b>
<b>Appendix A &lt;I/O Port Pin Assignment&gt;</b> .....	<b>40</b>
A.1 <Serial ATA Port> .....	40
A.2 <IrDA Port> .....	40
A.3 <Serial Port 1> .....	40
A.4 <IDE Port> .....	41
A.5 <VGA Port> .....	42
A.6 <LAN Port> .....	42
A.7 < USB Interface > .....	42
<b>Appendix B &lt;Flash BIOS&gt;</b> .....	<b>43</b>
B.1 <Flash Tool> .....	43
B.2 <Flash BIOS Procedure> .....	43
<b>Appendix C &lt;System Resources&gt;</b> .....	<b>44</b>
<b>Appendix D &lt;Programming GPIO's&gt;</b> .....	<b>48</b>
<b>Appendix E &lt;Programming Watchdog Timer &gt;</b> ..	<b>49</b>
<b>Contact Information</b> .....	<b>50</b>

(This page is left for blank)

## Chapter 1 <Introduction>

### 1.1 <Product Overview>

**2808160** is the Mini-ITX miniboard, with Intel® Atom N270 processor for 533 MHz front side bus, Intel® 945GSE and ICH7M chipset, integrated GMA950 graphics, DDR2 SO-DIMM memory, Realtek HD Audio, Serial ATA and two Intel® 82574L Gigabit LAN.

#### **Intel Atom Processor**

The Intel® Atom N270 single core processor is with 533 MHz front side bus, 512KB L2 cache. It's built on 45nm process technology support Hyper-Threading Technology, Enhanced Intel SpeedStep® Technology reduces average system power consumption.

#### **Mobile Intel® 945GSE chipset**

The board integrates Intel® 945GSE and ICH7M chipset. The chipset features power-efficient graphics with an integrated 32-bit 3D graphics engine based on Intel® Graphics Media Accelerator 950 architecture with LVDS, CRT, and TV-Out display ports. It provides I/O capabilities and flexibility via high-bandwidth interfaces such as PCI, Serial ATA and Hi-Speed USB 2.0 connectivity. It also includes a single channel for 400/533 MHz DDR2 system memory (SODIMM), HD Audio with 7.1channels surrounding sound.

#### **All in One multimedia solution**

Based on Intel 945GSE and ICH7M chipset, the board provides high performance onboard graphics, 18-bit Dual channel LVDS interface, HDTV and 7.1 channels HD Audio, to meet the every requirement of the multimedia application.

#### **Flexible Extension Interface**

The board also provides Compact Flash Type II socket, PCI, Mini-PCI and one PCIE mini card socket.

## 1.2 <Product Specification>

### General Specification

Form Factor	Mini-ITX motherboard
CPU	Intel® Atom N270 processor Package type: FCBGA8 Front side bus: 533MHz
Memory	1 x 200-pin DDR2 SO-DIMM SDRAM up to 2GB Unbuffered, none-ECC memory supported only
Chipset	Intel® 945GSE and ICH7M
BIOS	Phoenix-Award v6.00PG 8Mb SPI flash BIOS
Green Function	Power saving mode includes doze, standby and suspend modes. ACPI version 1.0 and APM version 1.2 compliant
Watchdog Timer	System reset programmable watchdog timer with 1 ~ 255 sec./min. of timeout value
Real Time Clock	Intel® ICH7M built-in RTC with lithium battery
Enhanced IDE	UltraDMA33 IDE interface supports up to 2 ATAPI devices One 44-pin IDE port onboard One CompactFlash Type II socket
Serial ATA	Intel® ICH7M integrates 2 Serial ATA interfaces (No RAID Function) Up to 150MB/s of transfer rate

### Multi-I/O Port

Chipset	Intel® ICH7M with Winbond® W83627THG controller
Serial Port	One RS-232/422/485 serial port and Five RS-232
USB Port	Six external & Two internal Hi-Speed USB 2.0 ports with 480Mbps of transfer rate
IrDA Port	One IrDA compliant Infrared interface supports SIR
K/B & Mouse	External PS/2 keyboard and mouse ports on rear I/O panel
GPIO	One 12-pin Digital I/O connector with 8-bit programmable I/O interface
Smart Fan	One CPU fan connectors for fan speed controllable

### VGA Display Interface

Chipset	Intel® 945GSE GMCH (Graphic Memory Controller Hub)
Frame Buffer	Up to 224MB shared with system memory
Display Type	CRT, LCD monitor with analog display LVDS1, HDTV, <b>LVDS2 (2808160C only) DVI (2808160B only)</b>
Connector	External DB15 female connector on rear I/O panel On board 40-pin LVDS1 connector On board 10-pin TV-out connector <b>On board 40-pin LVDS2 connector (2808160C only)</b> <b>On board 26-pin DVI connector (2808160B only)</b>



**Ethernet Interface**

Controller	2 x Intel 82574L Gigabit Ethernet controller
Type	Triple speed 10/100/1000Base-T auto-switching Fast Ethernet Full duplex, IEEE802.3U compliant
Connector	Two External RJ45 connector with LED on rear I/O panel

**Audio Interface**

Chipset	Intel integrated with Realtek ALC888 HD Audio Intel High Definition Audio compliance
Interface	7.1 channels sound output
Connector	External Audio phone jack for Line-out, Line-in, MIC-in, Surround, Center and Backsurround Onboard front audio connector with pin header Onboard CD-IN and external optical S/PDIF connector

**Expansive Interface**

PCI	PCI slot (32-bit, 33MHz) Power supply: +3.3V, +5V, 3VSB +12V, -12V
Mini PCI	One Mini-PCI socket <b>TYPE III A</b> (32-bit, 33MHz) Power supply: +3.3V, +5V, 3VSB
PCIE mini card	One PCIE mini card socket Power supply: +1.5V, 3VSB

**Power and Environment**

Power Requirement	Standard 24-pin ATX power supply (20-pin is compatible)
Dimension	170 (L) x170(H) mm
Temperature	Operating within 0 ~ 60°C Storage within -20 ~ 85°C

**Ordering Code**

2808160	Intel Atom processor with onboard VGA, LVDS for 18-bit Audio, SATA, GLAN, USB2.0, CF, GPIO, Mini PCI, PCIE mini card
2808160B	Same as above and with DVI
2808160C	Same as above and with secondary LVDS for 18-bits
1008099	18bit LVDS to TTL module
1507780	PCI Express mini card supports single Giga LAN
1507790	PCI Express mini card supports dual Giga LAN

## 1.2 <Mechanical Drawing>

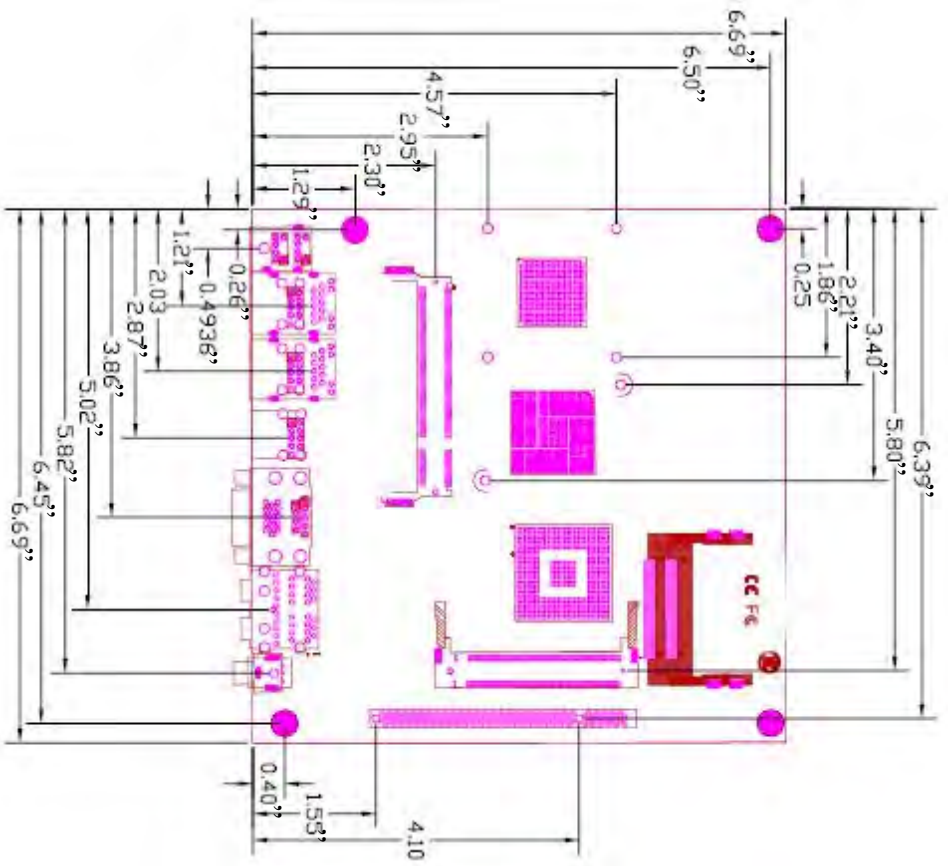

### 1.3 <Block Diagram>

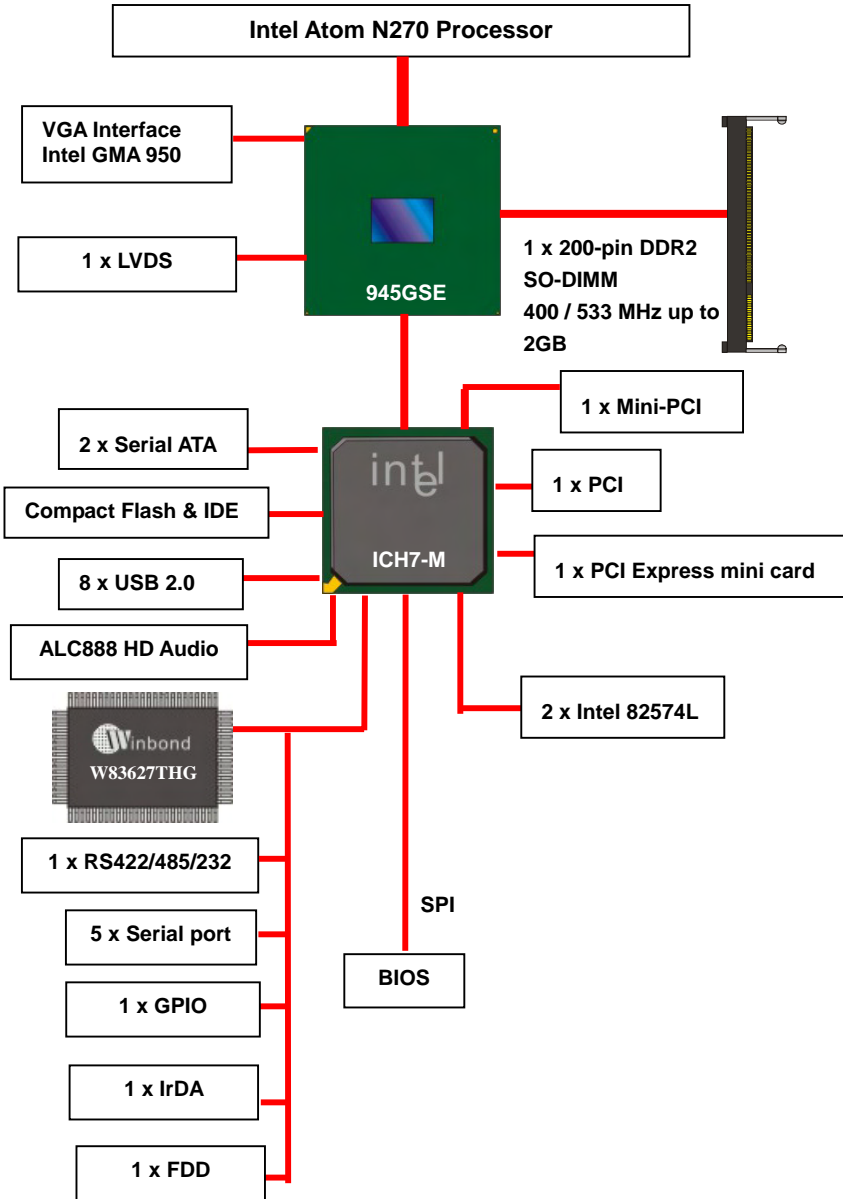

# Chapter 2 <Hardware Setup>

## 2.1 <Connector Location>

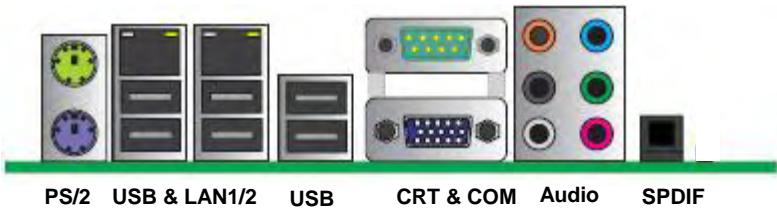
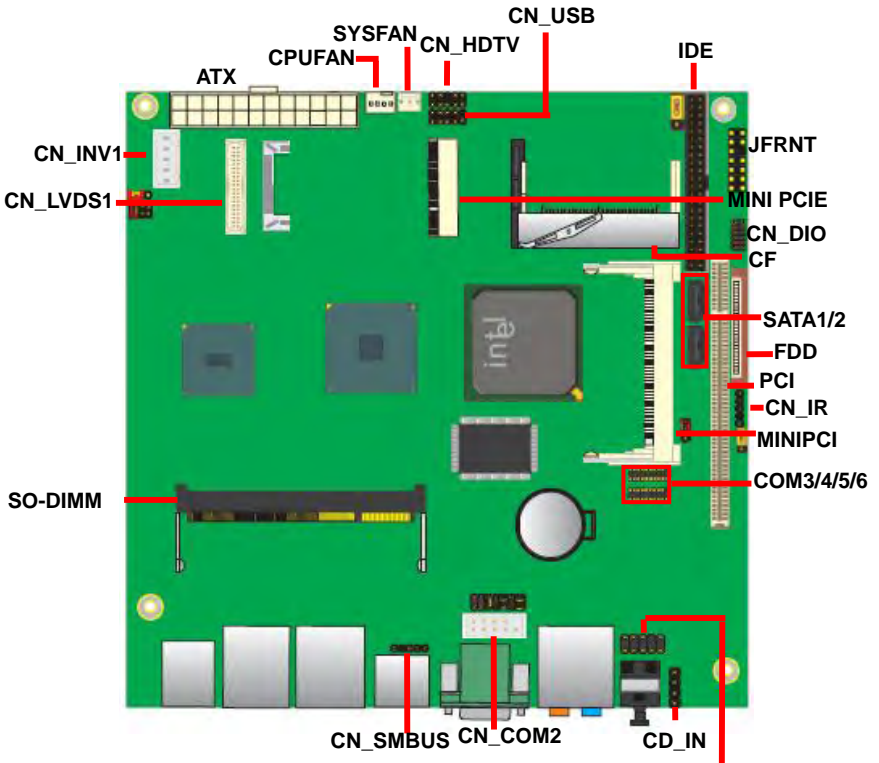

### 1.3 <Block Diagram>

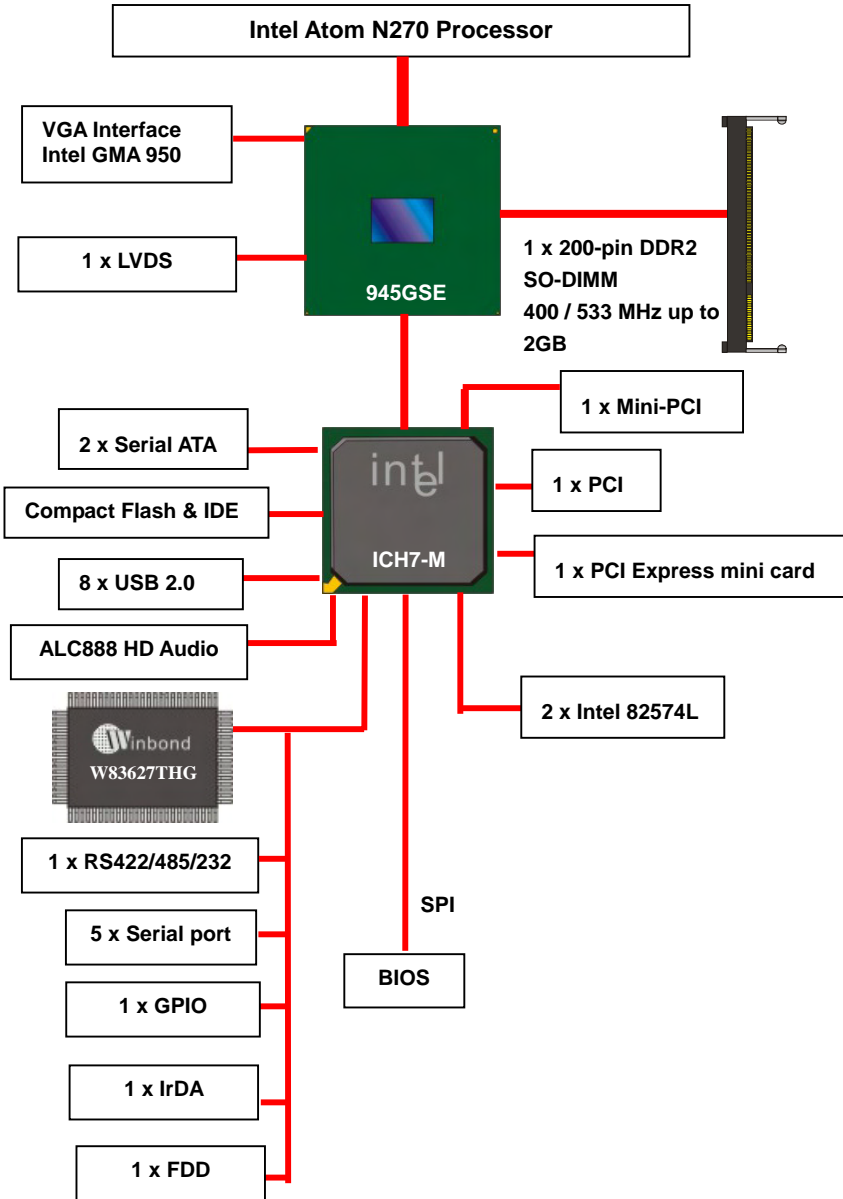

## 1.2 &lt;Mechanical Drawing&gt;

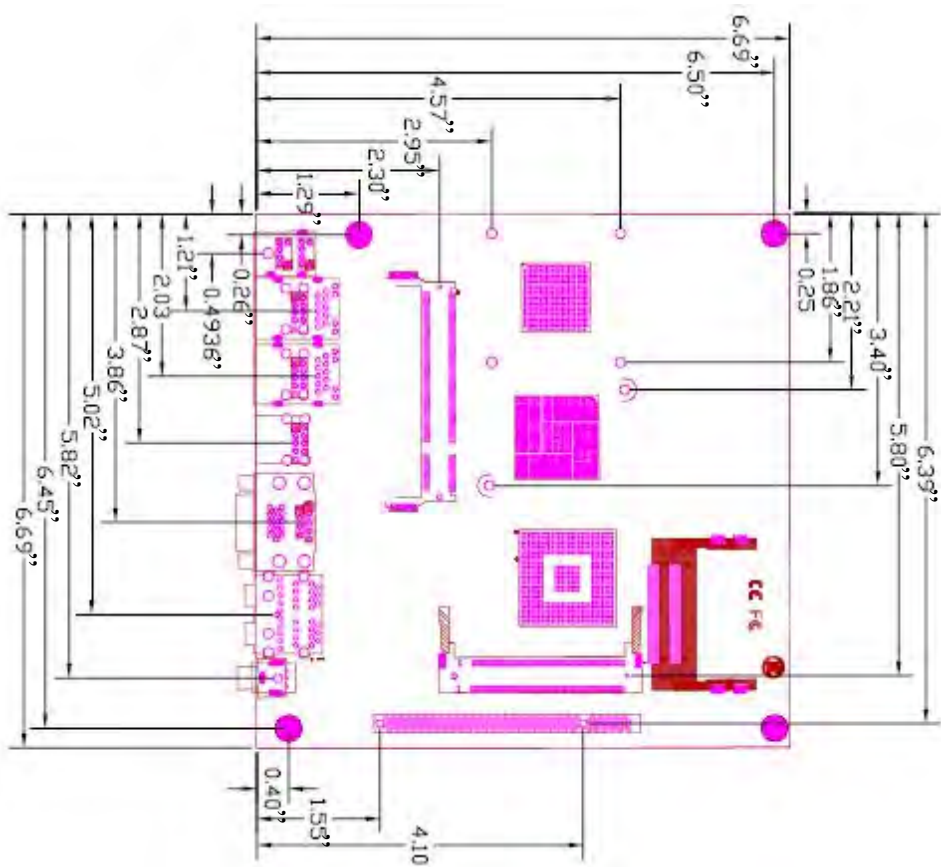

## 2.4 <Memory Setup>

The board provides one 200-pin DDR2 SO-DIMM to support DDR2 533 memory modules up to 2GB of capacity. Non-ECC, unbuffered memory is supported only.

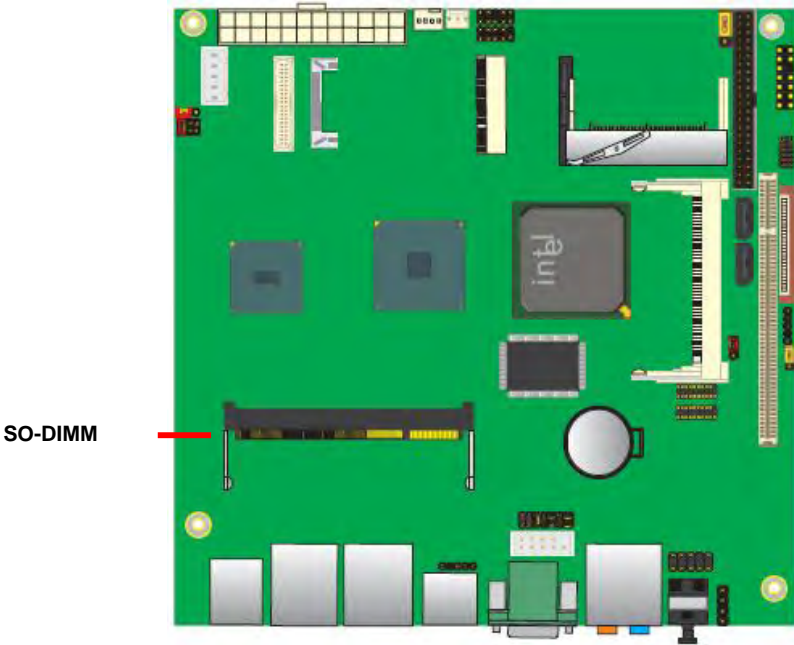

## 2.5 <CMOS Setup>

The board's data of CMOS can be setting in BIOS. If the board refuses to boot due to inappropriate CMOS settings, here is how to proceed to clear (reset) the CMOS to its default values.

### Jumper: JRTC

Type: Onboard 3-pin jumper

JRTC	Mode
1-2	Clear CMOS
2-3	Normal Operation

Default setting: 2-3

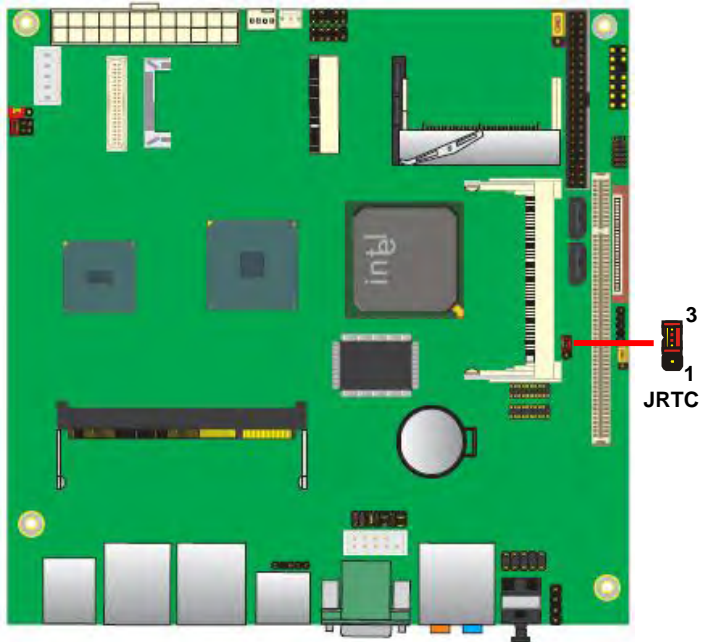



## 2.6 <Enhanced IDE & CF Interface>

The board has one Ultra DMA33 IDE interface to support up to 2 ATAPI devices, and one Compact Flash Type II socket.

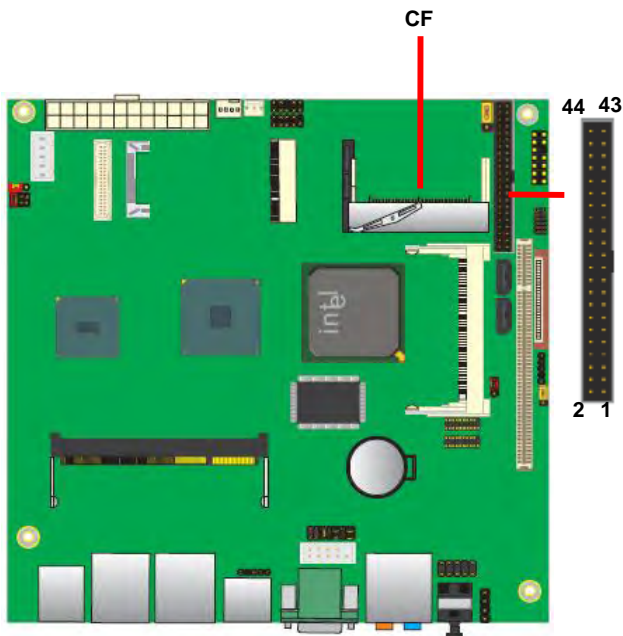

## 2.7 <Serial ATA Interface>

Based on Intel ICH7-M, the board provides four Serial ATAII interfaces with up to 150MB/s of transfer rate.

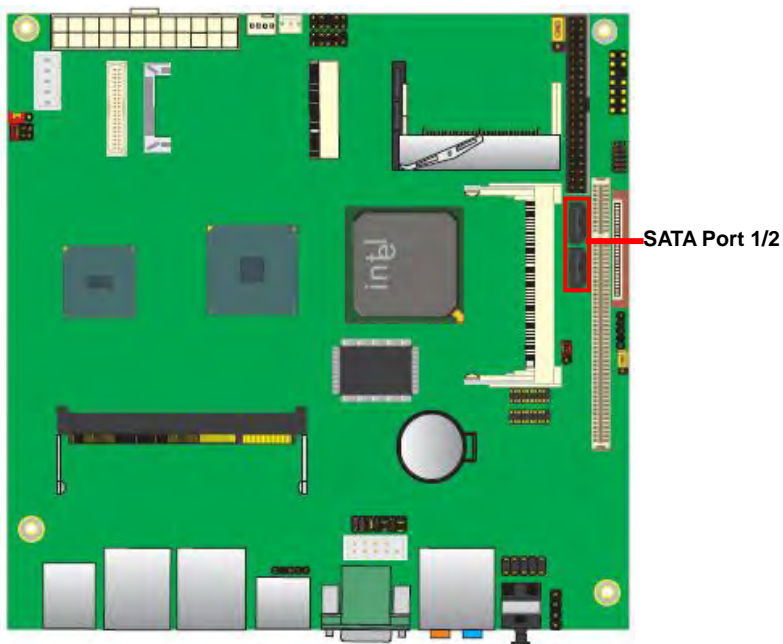

## 2.8 <Ethernet Interface>

The board integrates with two Intel 82574L Gigabit Ethernet controllers, as the PCI Express x1 can speed up to 250MB/s of transfer rate instead of late PCI bus with 133MB/s of transfer rate. The Intel Gigabit Ethernet supports triple speed of 10/100/1000Base-T, with IEEE802.3 compliance and Wake-On-LAN supported.

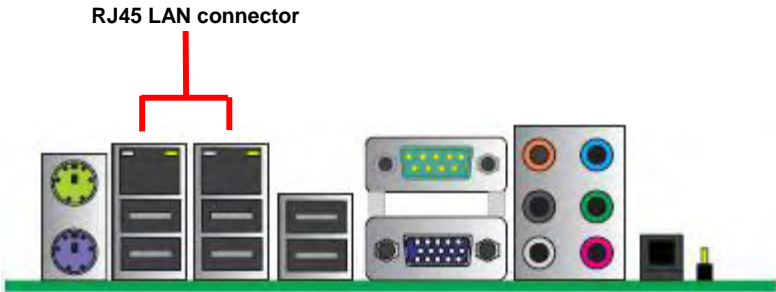

## 2.9 <Onboard Display Interface>

Based on Intel 945GSE chipset with built-in GMA (Graphic Media Accelerator) 950 graphics, the board provides one DB15 connector on rear external I/O port, and one 40-pin LVDS interface with 5-pin LCD backlight inverter connector. The board provides dual display function with clone mode and extended desktop mode for CRT, LCD, HDTV.

### 2.9.1 <Analog Display>

Please connect your CRT or LCD monitor with DB15 male connector to the onboard DB15 female connector on rear I/O port.

The board supports up to 2048 x 1536 (QXGA) of resolution.

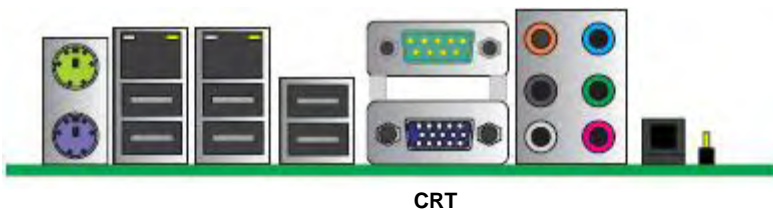

## 2.9.2 <Digital Display>

The board provides one 40-pin LVDS connector for 18-bit dual channel panels, supports up to 1600 x 1200 (UXGA) resolution, with one LCD backlight inverter connector and jumper for panel & inverter voltage setting.

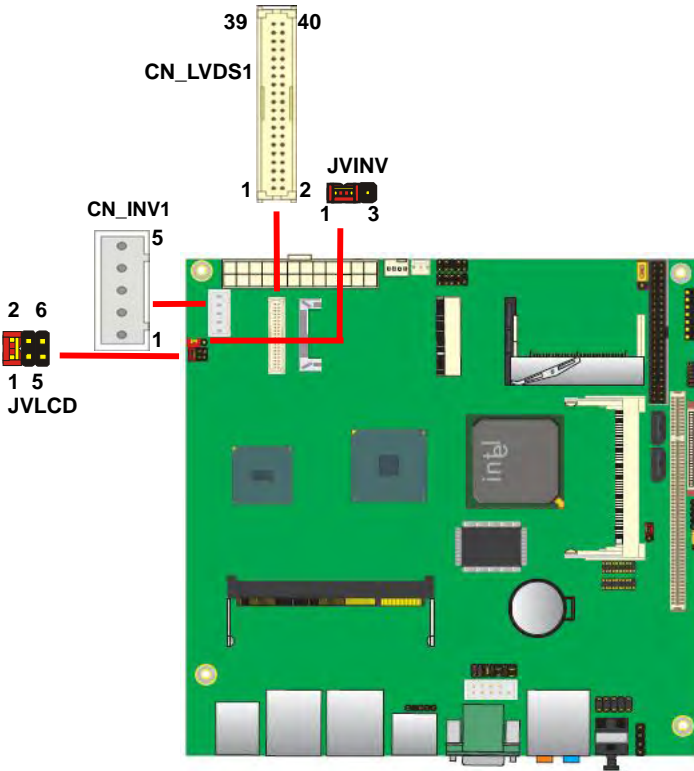

### 2.9.3 <LVDS2 Interface 2808160C only >

The board provides another 40-pin LVDS connector for 18/24bit dual channel panels. Supports up to 1600 x 1200 (UXGA) of resolution, with CN\_INV2 LCD backlight inverter connector (2808160C only).

The panel & inverter voltage setting shared with LVDS1.

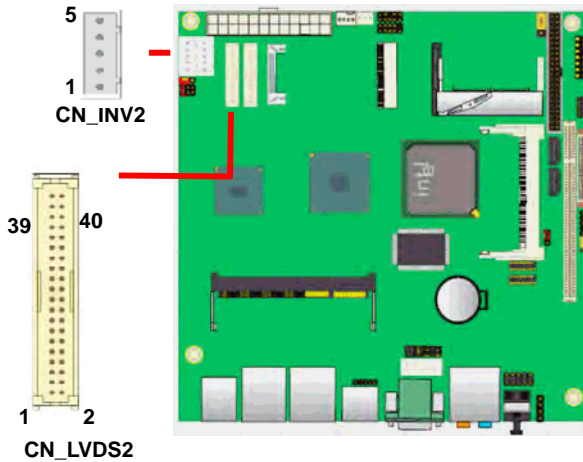

Connector: **CN\_INV1/2**

Type: 5-pin LVDS Power Header

Pin	Description
1	INV_V
2	GND
3	GND
4	GND
5	ENABKL

Connector: **JVLCD**

Type: 6-pin Power select Header

Pin	Description
1-2	LCDVCC (3.3V)
3-4	LCDVCC (5V)
5-6	LCDVCC (12V)

Default: 1-2

Connector: **JVINV**

Type: 3-pin INV\_V power select Header

Pin	Description
1-2	INV_V (12V)
2-3	INV_V (5V)

Default: 1-2

Connector: **CN\_LVDS**

Type: onboard 40-pin connector for LVDS connector

Connector model: **HIROSE DF13-40DP-1.25V**

Pin	Signal	Pin	Signal
2	LCDVCC	1	LCDVCC
4	GND	3	GND
6	ATX0-	5	BTX0-
8	ATX0+	7	BTX0+
10	GND	9	GND
12	ATX1-	11	BTX1-
14	ATX1+	13	BTX1+
16	GND	15	GND
18	ATX2-	17	BTX2-
20	ATX2+	19	BTX2+
22	GND	21	GND
24	ACLK-	23	BTX3-(2808160C)
26	ACLK+	25	BTX3+(2808160C)
28	GND	27	GND
30	ATX3- (2808160C)	29	BCLK-
32	ATX3+(2808160C)	31	BCLK+
34	GND	33	GND
36	N/C	35	N/C
38	N/C	37	N/C
40	N/C	39	N/C

To setup the LCD, you need the component below:

1. A panel with LVDS interfaces.
2. An inverter for panel's backlight power.
3. A LCD cable and an inverter cable.

**For the cables, please follow the pin assignment of the connector to make a cable, because every panel has its own pin assignment, so we do not provide a standard cable; please find a local cable manufacture to make cables.**

### LCD Installation Guide:

1. Preparing the **2808160**, **LCD panel** and the **backlight inverter**.

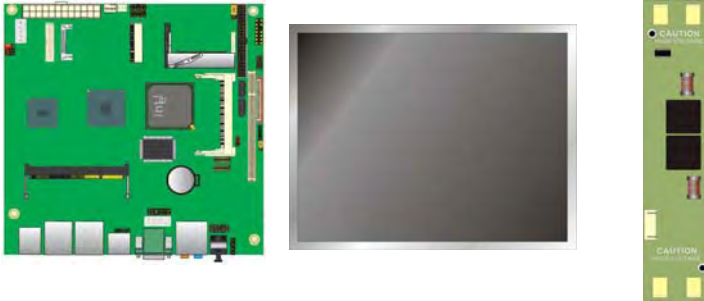

2. Please check the datasheet of the panel to see the voltage of the panel, and set the jumper **JVLCD** to +12V or +5V or +3.3V.
3. You would need a LVDS type cable.



4. To connect all of the devices well.

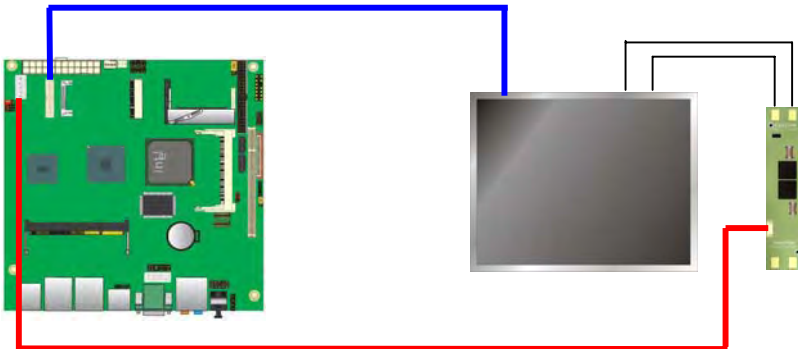



After setup the devices well, you need to select the LCD panel type in the BIOS.

The panel type mapping is list below:

<b>BIOS panel type selection form</b>			
<b>On board 18 bit LVDS</b>			
<b>Single Channel</b>		<b>Dual Channel</b>	
<b>NO.</b>	<b>Output format</b>	<b>NO.</b>	<b>Output format</b>
1	640 x 480	9	1280 x 768
2	800 x 480		
3	800 x 600		
4	1024 x 600		
5	1024 x 768		
6	1280 x 600		
7	1280 x 768		
8	1280 x 800		

<b>External 24bit LVDS &lt;2808160C only&gt;</b>			
<b>Single Channel</b>		<b>Dual Channel</b>	
<b>NO.</b>	<b>Output format</b>		<b>Output format</b>
1	640 x 480	4	1280 x 1024
2	800 x 480		
3	1024 x 768		

### 2.9.4 <DVI Interface 2808160C only >

The board also comes with a DVI interface with Chrontel CH7307C for digital video interface. Supports up to 1600 x 1200 (UXGA) of resolution. (2808160B only)

Connector: **CN\_DVI**

Connector type: 26-pin header connector (pitch = 2.00mm)

Pin Number	Assignment	Pin Number	Assignment
1	TX1+	2	TX1-
3	Ground	4	Ground
5	TXC+	6	TXC-
7	Ground	8	PVDD
9	N/C	10	N/C
11	TX2+	12	TX2-
13	Ground	14	Ground
15	TX0+	16	TX0-
17	N/C	18	HPDET
19	DDCDATA	20	DDCCLK
21	GND	22	N/C
23	N/C	24	N/C
25	N/C	26	N/C

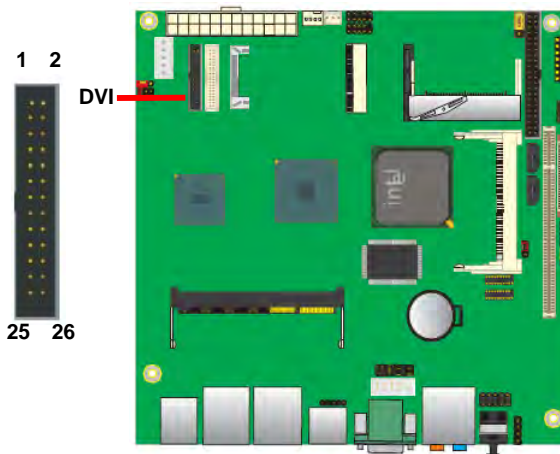

## 2.9.5 <HDTV Interface>

The board provides an HDTV interface with Intel 945GSE, support PAL and NTSC of TV system, and display (clone or extended desktop) function with CRT, LVDS.

Connector: **CN\_HDTV**

Connector type: 10-pin header HDTV connector (pitch = 2.54mm)

Pin Number	Assignment	Pin Number	Assignment
1	GND	2	DACB_L
3	DACC_L	4	GND
5	GND	6	N/C
7	DACA_L	8	GND
9	N/C	10	N/C

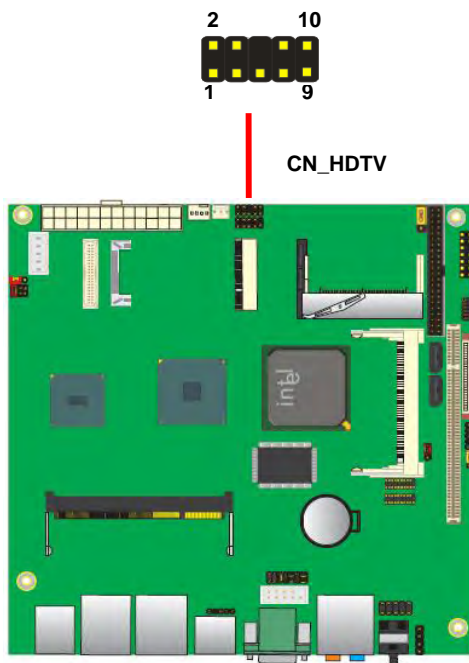

## 2.10 <Integrated Audio Interface>

The board integrates onboard audio interface with REALTEK ALC888 codec, with Intel next generation of audio standard as High Definition Audio, it offers more sound and other advantages than former HD audio compliance.

The main specifications of ALC888 are:

- High-performance DACs with 100dB S/N ratio
- 8 DAC channels support 16/20/24-bit PCM format for 7.1 audio solution
- 16/20/24-bit S/PDIF-OUT supports 44.1K/48K/96kHz sample rate
- Compatible with HD
- Meets Microsoft WHQL/WLP 2.0 audio requirements

The board provides 7.1 channels audio phone jacks on rear I/O port, and Line-in/MIC-in ports for front I/O panel through optional cable.

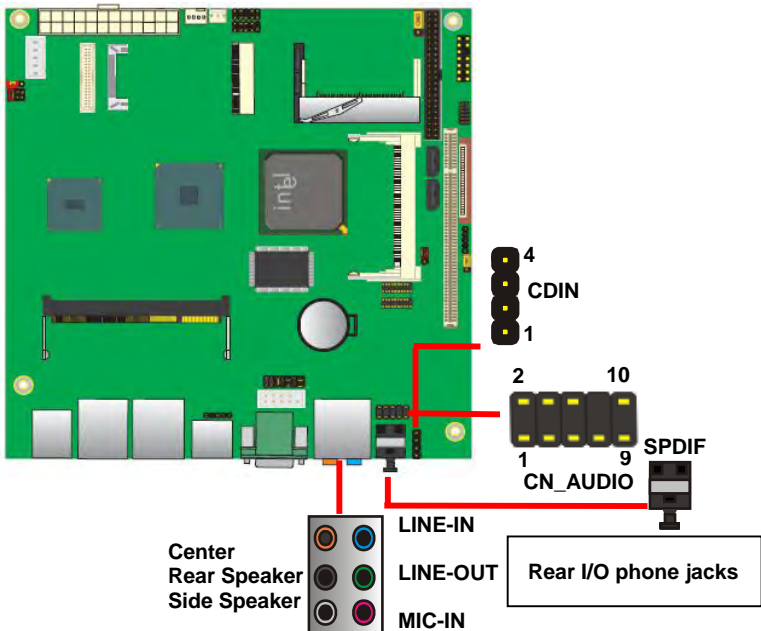

**Connector: CN\_AUDIO**

Type: 10-pin (2 x 5) header (pitch = 2.54mm)

Pin	Description	Pin	Description
1	MIC_L	2	Ground
3	MIC_R	4	Reserve
5	Speaker_R	6	MIC Detect
7	SENSE	8	N/C
9	Speaker_L	10	Speaker Detect

**Connector: CDIN**

Type: 4-pin header (pitch = 2.54mm)

Pin	Description
1	CD – Left
2	Ground
3	Ground
4	CD – Right

## 2.11 <GPIO Interface & SMBUS>

The board provides a programmable 8-bit digital I/O interface; you can use this general purpose I/O port for system control like POS or KIOSK.

Connector: **CN\_DIO**

Type: 12-pin (6 x 2) header (pitch = 2.0mm)

Pin	Description	Pin	Description
1	Ground	2	Ground
3	GP10	4	GP14
5	GP11	6	GP15
7	GP12	8	GP16
9	GP13	10	GP17
11	VCC	12	+12V

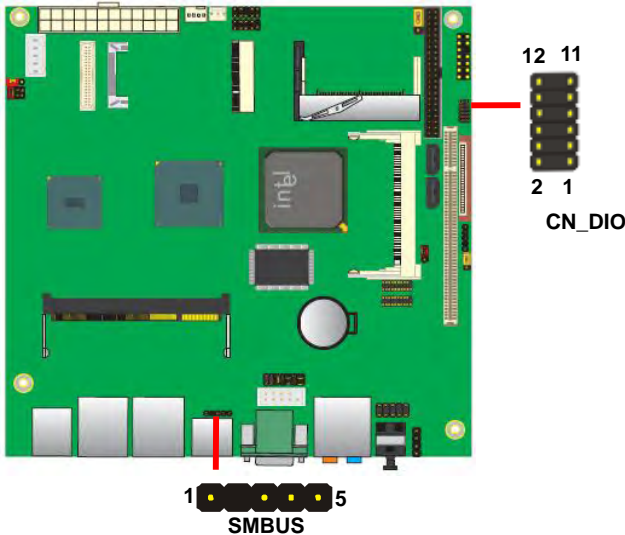

Connector: **CN\_SMBUS**

Type: 5-pin 2.54-pitch header

Pin	Description
1	VCC
2	N/C
3	SMBDATA
4	SMBCLK
5	Ground

## 2.12 <Serial Port>

The board supports one RS232 serial port and one jumper selectable RS232/422/485 serial ports. The jumper JCSEL1 & JCSEL2 can let you configure the communicating modes for COM2.

Connector: **CN\_COM2**

Type: 10-pin (5 x 2) 2.54mm x 2.54mm-pitch box header for COM2

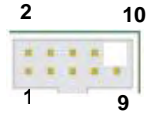

Pin	Description	Pin	Description
1	DCD/422TX-/485-	2	RXD/422TX+/485+
3	TXD/422RX+	4	DTR/422RX-
5	GND	6	DSR
7	RTS	8	CTS
9	RI	10	N/C

Connector: **CN\_COM3/4/5/6**

Type: 20-pin (10x2) header





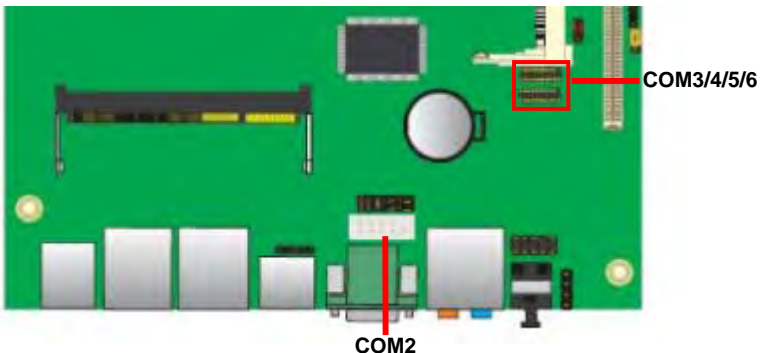



Pin	Description	Pin	Description
1	DCD1-	2	RXD1+
3	TXD1+	4	DTR1-
5	Ground	6	DSR1-
7	RTS1-	8	CTS1-
9	RI1-	10	N/C
11	DCD2-	12	RXD2+
13	TXD2+	14	DTR2-
15	Ground	16	DSR2-
17	RTS2-	18	CTS2-
19	RI2-	20	N/C



Jumper: **JCSEL1 & JCSEL2**

Type: Onboard 6-pin & 12-pin jumper

Function	JCSEL1	JCSEL2
<b>RS-232</b>	1 5  2 6	1 11  2 12
<b>RS-485</b>	1 5  2 2	1 11  2 12
<b>RS-422</b>	1 5  2 6	1 11  2 12

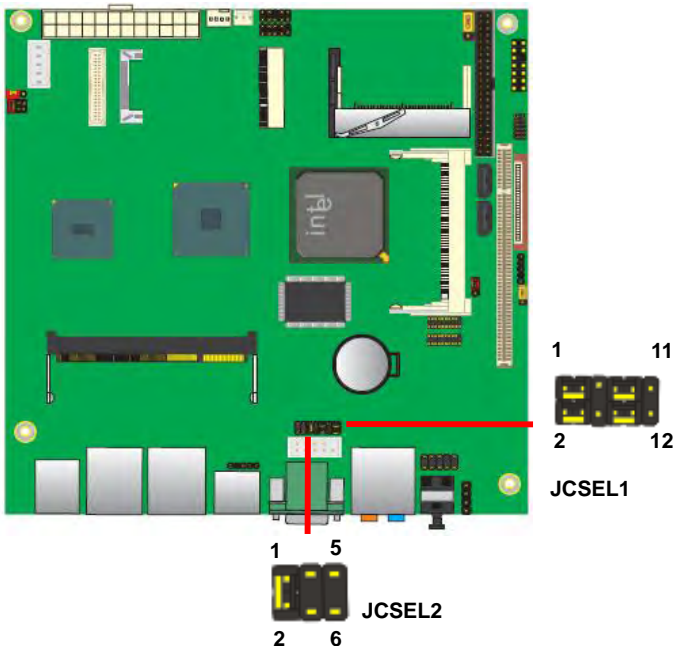



## 2.13 <Power Supply>

The 2808160 provides a standard ATX power supply with 24-pin ATX connector with 3-pin jumper to simulate AT power, and the board provides one 4-pin fan connector supporting smart fan for CPU cooler and one 3-pin cooler fan connector for system.

### 2.13.1 <Power connector>

Connector: **ATX**

Type: 24-pin ATX power connector

PIN assignment			
1	3.3V	13	3.3V
2	3.3V	14	-12V
3	GND	15	GND
4	5V	16	-PSON
5	GND	17	GND
6	5V	18	GND
7	GND	19	GND
8	PW OK	20	-5V
9	5V SB	21	5V
10	12V	22	5V
11	12V	23	5V
12	3.3V	24	GND

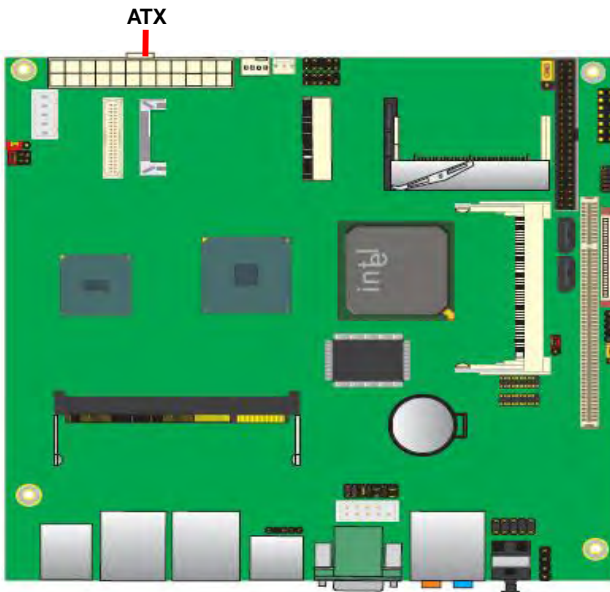

2.13.2 <Fan connector & JAT JUMPER>

Connector: **SYSFAN**

Type: 3-pin fan wafer connector

Pin	Description	Pin	Description	Pin	Description
1	Ground	2	+12V	3	Fan Control

Connector: **CPUFAN**

Type: 4-pin fan wafer connector

Pin	Description	Pin	Description
1	Ground	2	+12V
3	Fan Speed Detection	4	Sense

Jumper: **JAT**

Type: onboard 3-pin header

Power Mode	JAT
AT Mode	1-2
ATX Mode	2-3

Default setting: **ATX Mode**

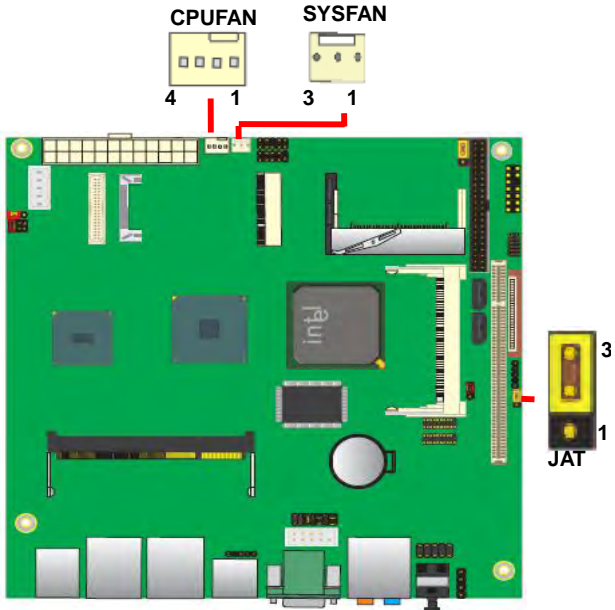

## 2.14 <Switch and Indicator>

The **JFRNT** provides front control panel of the board, such as power button, reset and beeper, etc. Please check well before you connecting the cables on the chassis.

Connector: **JFRNT**

Type: onboard 14-pin (2 x 7) 2.54-pitch header

Function	Signal	PIN		Signal	Function
IDE LED	HDLED+	1	2	PWRLED+	Power LED
	HDLED-	3	4	N/C	
Reset	Reset+	5	6	PWRLED-	Speaker
	Reset-	7	8	SPK+	
N/C		9	10	N/C	
Power Button	PWRBT+	11	12	N/C	
	PWRBT-	13	14	SPK-	

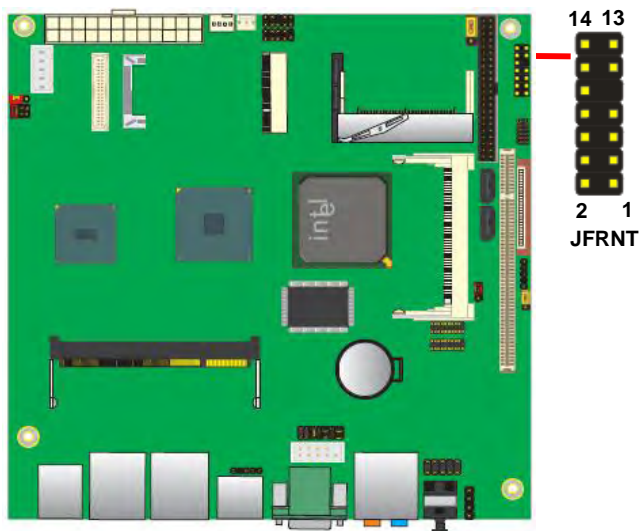

## Chapter 3 <System Setup>

### 3.1 <Audio Configuration>

Based on Intel® 945GSE chipset with GMA 950 (Graphic Media Accelerator) , the board supports Intel® DVM (Dynamic Video Memory Technology) 3.0, which would allow the video memory to be allocated up to 224MB.



1. Select Speaker Configuration



## 3.2 <Display Properties Setting>

Based on Intel 945GSE GMCH with GMA 950(Graphic Media Accelerator), the board supports two DACs for display device as different resolution and color bit.

Please install the Intel Graphic Driver before you starting setup display devices.

1. Click right button on the desktop to lunch **display properties**

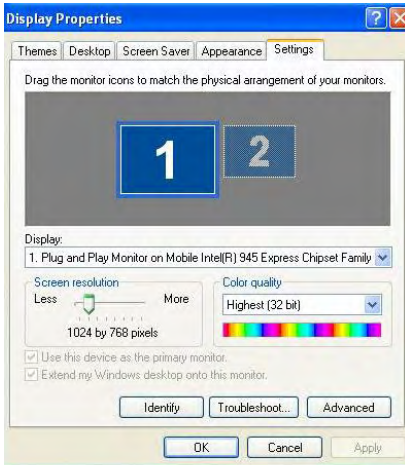

2. Click **Advanced** button for more specificity setup.



Click **Graphics Properties...** for advanced setup

3. This setup options can let you define each device settings.

Click **Monitor** to setup the CRT monitor for Colors, Resolution and Refresh Rate

Click **Intel® Dual Display Clone** to setup the dual display mode as same screen

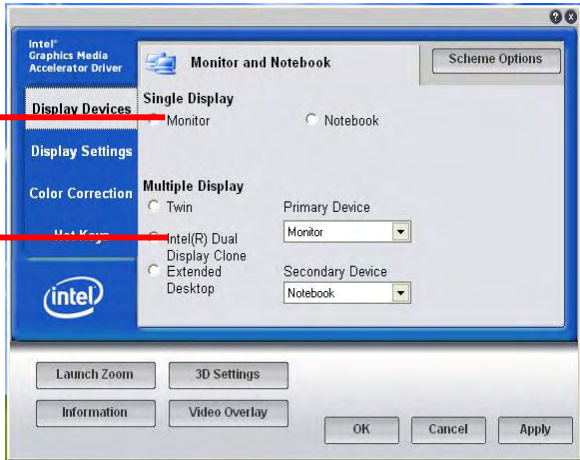

**Note: Dual LVDS display supports Extended mode only.**

## Chapter 4 <BIOS Setup>

The motherboard uses the Award BIOS for the system configuration. The Award BIOS in the single board computer is a customized version of the industrial standard BIOS for IBM PC AT-compatible computers. It supports Intel x86 and compatible CPU architecture based processors and computers. The BIOS provides critical low-level support for the system central processing, memory and I/O sub-systems.

The BIOS setup program of the single board computer let the customers modify the basic configuration setting. The settings are stored in a dedicated battery-backed memory, NVRAM, retains the information when the power is turned off. If the battery runs out of the power, then the settings of BIOS will come back to the default setting.

The BIOS section of the manual is subject to change without notice and is provided here for reference purpose only. The settings and configurations of the BIOS are current at the time of print, and therefore they may not be exactly the same as that displayed on your screen.

To activate CMOS Setup program, press <DEL> key immediately after you turn on the system. The following message "Press DEL to enter SETUP" should appear in the lower left hand corner of your screen. When you enter the CMOS Setup Utility, the Main Menu will be displayed as **Figure 4-1**. You can use arrow keys to select your function, press <Enter> key to accept the selection and enter the sub-menu.

**Figure 4-1** CMOS Setup Utility Main Screen

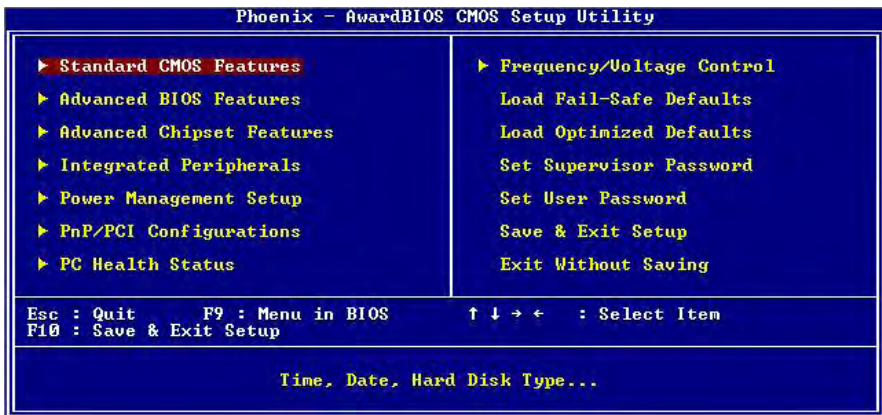

(This page is left for blank)



## Appendix A <I/O Port Pin Assignment>

### A.1 <Serial ATA Port>

Connector: **SATA1/2**

Type: 7-pin wafer connector

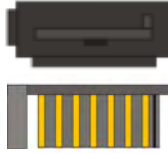

1	2	3	4	5	6	7	8	9
GND	RSATA_TXP1	RSATA_TXN1	GND	RSATA_RXN1	RSATA_RXP1	GND	GND	GND

### A.2 <IrDA Port>

Connector: **CN\_IR**

Type: 5-pin header for SIR Ports

Pin	Description
1	VCC
2	N/C
3	IRRX
4	Ground
5	IRTX



### A.3 <Serial Port 1>

Connector: **COM1**

Type: 9-pin D-sub male connector on bracket



Pin	Description	Pin	Description
1	DCD-	6	DSR
2	SIN-	7	RTS
3	SO-	8	CTS
4	DTR-	9	RI
5	Ground		

## A.4 <IDE Port>

Connector: IDE

Type: 44-pin (22 x 2) box header



Pin	Description	Pin	Description
1	Reset	2	Ground
3	D7	4	D8
5	D6	6	D9
7	D5	8	D10
9	D4	10	D11
11	D3	12	D12
13	D2	14	D13
15	D1	16	D14
17	D0	18	D15
19	Ground	20	N/C
21	REQ	22	Ground
23	IOW-/STOP	24	Ground
25	IOR-/HDMARDY	26	Ground
27	IRDY/DDMARDY	28	Ground
29	DACK-	30	Ground
31	IRQ	32	N/C
33	A1	34	SD
35	A0	36	A2
37	CS1	38	CS3
39	ASP1	40	Ground
41	Vcc	42	Vcc
43	Ground	44	Ground

## A.5 <VGA Port>

Connector: **CRT**

Type: 15-pin D-sub female connector on bracket

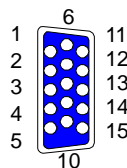

Pin	Description	Pin	Description	Pin	Description
1	RED	6	Ground	11	N/C
2	GREEN	7	Ground	12	DDCDA
3	BLUE	8	Ground	13	HSYNC
4	N/C	9	N/C	14	VSYNC
5	Ground	10	Ground	15	DDCCLK

## A.6 <LAN Port>

Connector: **RJ45**

Type: RJ45 connector with LED on bracket



Pin	1	2	3	4	5	6	7	8
Description	MI0+	MI0-	MI1+	MI2+	MI2-	MI1-	MI3+	MI3-

## A.7 < USB Interface >

Connector: **CN\_USB**

Type: 10-pin (5 x 2) header for dual USB Ports



Pin	Description	Pin	Description
1	VCC	2	VCC
3	Data0-	4	Data1-
5	Data0+	6	Data1+
7	Ground	8	Ground
9	Ground	10	N/C

**Note: CN\_USB/Odd pin shared with Mini-card USB interface.**

**Please don't insert the USB cable on CN\_USB of Odd pin, if Mini-PCIE has used USB interface.**

## Appendix B <Flash BIOS>

### B.1 <Flash Tool>

The board is based on Award BIOS and can be updated easily by the BIOS auto flash tool. You can download the tool online at the address below:

<http://www.phoenix.com/en/home/>

File name of the tool is "awdf flash.exe", it's the utility that can write the data into the BIOS flash chip and update the BIOS.

### B.2 Flash Method

1. Please make a bootable floppy disk.
2. Get the last .bin files you want to update and copy it into the disk.
3. Copy awardflash.exe to the disk.
4. Power on the system and flash the BIOS. (Example: C:/ awardflash XXX.bin)
5. Re-start the system.

Any question about the BIOS re-flash please contact your distributors or visit the web-site at below:

<http://www.globalamericaninc.com>

---

## Appendix C <System Resources>

### C1. <I/O Port Address Map>

[00000000 - 0000000F]	Direct memory access controller
[00000000 - 00000CF7]	PCI bus
[00000010 - 0000001F]	Motherboard resources
[00000020 - 00000021]	Programmable interrupt controller
[00000022 - 0000003F]	Motherboard resources
[00000040 - 00000043]	System timer
[00000044 - 0000005F]	Motherboard resources
[00000060 - 00000060]	Standard 101/102-Key or Microsoft Natural PS/2 Keyboard
[00000061 - 00000061]	System speaker
[00000062 - 00000063]	Motherboard resources
[00000064 - 00000064]	Standard 101/102-Key or Microsoft Natural PS/2 Keyboard
[00000065 - 0000006F]	Motherboard resources
[00000070 - 00000073]	System CMOS/real time clock
[00000074 - 0000007F]	Motherboard resources
[00000080 - 00000090]	Direct memory access controller
[00000091 - 00000093]	Motherboard resources
[00000094 - 0000009F]	Direct memory access controller
[000000A0 - 000000A1]	Programmable interrupt controller
[000000A2 - 000000BF]	Motherboard resources
[000000C0 - 000000DF]	Direct memory access controller
[000000E0 - 000000EF]	Motherboard resources
[000000F0 - 000000FF]	Numeric data processor
[00000170 - 00000177]	Secondary IDE Channel
[000001F0 - 000001F7]	Primary IDE Channel
[00000200 - 00000200]	Standard Game Port
[00000201 - 00000207]	Standard Game Port
[00000274 - 00000277]	ISAPNP Read Data Port
[00000279 - 00000279]	ISAPNP Read Data Port
[000002E8 - 000002EF]	Communications Port (COM4)
[000002F8 - 000002FF]	Communications Port (COM2)
[00000376 - 00000376]	Secondary IDE Channel
[00000378 - 0000037F]	Printer Port (LPT1)
[00000380 - 000003BB]	Mobile Intel(R) 945 Express Chipset Family
[000003C0 - 000003DF]	Mobile Intel(R) 945 Express Chipset Family

[000003E8 - 000003EF]	Communications Port (COM3)
[000003F0 - 000003F5]	Standard floppy disk controller
[000003F6 - 000003F6]	Primary IDE Channel
[000003F7 - 000003F7]	Standard floppy disk controller
[000003F8 - 000003FF]	Communications Port (COM1)
[00000400 - 000004BF]	Motherboard resources
[000004D0 - 000004D1]	Motherboard resources
[000004E8 - 000004EF]	Communications Port (COM6)
[000004F8 - 000004FF]	Communications Port (COM5)
[00000500 - 0000051F]	Intel(R) 82801G (ICH7 Family) SMBus Controller - 27DA
[00000778 - 0000077B]	Printer Port (LPT1)
[00000880 - 0000088F]	Motherboard resources
[00000A79 - 00000A79]	ISAPNP Read Data Port
[00000D00 - 0000FFFF]	PCI bus
[0000B000 - 0000BFFF]	Intel(R) 82801G (ICH7 Family) PCI Express Root Port - 27D0
[0000C000 - 0000CFFF]	Intel(R) 82801G (ICH7 Family) PCI Express Root Port - 27D4
[0000CF00 - 0000CF1F]	Intel(R) 82574L Gigabit Network Connection
[0000D000 - 0000DFFF]	Intel(R) 82801G (ICH7 Family) PCI Express Root Port - 27D2
[0000DF00 - 0000DF1F]	Intel(R) 82574L Gigabit Network Connection #2
[0000FA00 - 0000FA0F]	Intel(R) 82801GBM/GHM (ICH7-M Family) Serial ATA Storage Controller - 27C4
[0000FB00 - 0000FB1F]	Intel(R) 82801G (ICH7 Family) USB Universal Host Controller - 27CB
[0000FC00 - 0000FC1F]	Intel(R) 82801G (ICH7 Family) USB Universal Host Controller - 27CA
[0000FD00 - 0000FD1F]	Intel(R) 82801G (ICH7 Family) USB Universal Host Controller - 27C9
[0000FE00 - 0000FE1F]	Intel(R) 82801G (ICH7 Family) USB Universal Host Controller - 27C8
[0000FF00 - 0000FF07]	Mobile Intel(R) 945 Express Chipset Family

## C2. <Memory Address Map>

[00000000 - 0009FFFF]	System board
[000A0000 - 000BFFFF]	Mobile Intel(R) 945 Express Chipset Family
[000A0000 - 000BFFFF]	PCI bus
[000C0000 - 000DFFFF]	PCI bus
[000E0000 - 000EFFFF]	System board
[000F0000 - 000FFFFF]	System board
[00100000 - 7F6DFFFF]	System board
[7F6E0000 - 7F6FFFFF]	System board
[7F700000 - FEBFFFFF]	PCI bus
[D0000000 - DFFFFFFF]	Mobile Intel(R) 945 Express Chipset Family
[E0000000 - EFFFFFFF]	Motherboard resources
[FD600000 - FD6FFFFF]	Intel(R) 82801G (ICH7 Family) PCI Express Root Port - 27D0
[FD900000 - FD9FFFFF]	Intel(R) 82801G (ICH7 Family) PCI Express Root Port - 27D0
[FDA00000 - FDAFFFFF]	Intel(R) 82801G (ICH7 Family) PCI Express Root Port - 27D4
[FDB00000 - FDBFFFFF]	Intel(R) 82801G (ICH7 Family) PCI Express Root Port - 27D4
[FDBC0000 - FDBDFFFF]	Intel(R) 82574L Gigabit Network Connection
[FDBFC000 - FDBFFFFF]	Intel(R) 82574L Gigabit Network Connection
[FDC00000 - FDCFFFFF]	Intel(R) 82801G (ICH7 Family) PCI Express Root Port - 27D2
[FDD00000 - FDDFFFFF]	Intel(R) 82801G (ICH7 Family) PCI Express Root Port - 27D2
[FDDC0000 - FDDDFFFF]	Intel(R) 82574L Gigabit Network Connection #2
[FDDFC000 - FDDFFFFF]	Intel(R) 82574L Gigabit Network Connection #2
[FDE80000 - FDEFFFFF]	Mobile Intel(R) 945 Express Chipset Family
[FDF80000 - FDFBFFFF]	Mobile Intel(R) 945 Express Chipset Family
[FDFF8000 - FDFFBFFF]	Microsoft UAA Bus Driver for High Definition Audio
[FDFFF000 - FDFFF3FF]	Intel(R) 82801G (ICH7 Family) USB2 Enhanced Host Controller - 27CC
[FEB80000 - FEBFFFFF]	Mobile Intel(R) 945 Express Chipset Family
[FEC00000 - FEC0FFFF]	System board
[FED13000 - FED1DFFF]	System board
[FED20000 - FED8FFFF]	System board
[FEE00000 - FEE0FFFF]	System board
[FFB00000 - FFB7FFFF]	System board
[FFB80000 - FFBFFFFF]	Intel(R) 82802 Firmware Hub Device
[FFF00000 - FFFFFFFF]	System board

### C3. < IRQ Resources >

- (ISA) 0 System timer
- (ISA) 1 Standard 101/102-Key or Microsoft Natural PS/2 Keyboard
- (ISA) 3 Communications Port (COM2)
- (ISA) 4 Communications Port (COM1)
- (ISA) 5 Communications Port (COM5)
- (ISA) 6 Standard floppy disk controller
- (ISA) 7 Communications Port (COM3)
- (ISA) 7 Communications Port (COM4)
- (ISA) 8 System CMOS/real time clock
- (ISA) 9 Microsoft ACPI-Compliant System
- (ISA) 11 Communications Port (COM6)
- (ISA) 12 PS/2 Compatible Mouse
- (ISA) 13 Numeric data processor
- (ISA) 14 Primary IDE Channel
- (ISA) 15 Secondary IDE Channel
- (PCI) 11 Intel(R) 82801G (ICH7 Family) SMBus Controller - 27DA
- (PCI) 16 Intel(R) 82801G (ICH7 Family) PCI Express Root Port - 27D0
- (PCI) 16 Intel(R) 82801G (ICH7 Family) USB Universal Host Controller - 27CB
- (PCI) 16 Microsoft UAA Bus Driver for High Definition Audio
- (PCI) 16 Mobile Intel(R) 945 Express Chipset Family
- (PCI) 17 Intel(R) 82574L Gigabit Network Connection #2
- (PCI) 17 Intel(R) 82801G (ICH7 Family) PCI Express Root Port - 27D2
- (PCI) 18 Intel(R) 82574L Gigabit Network Connection
- (PCI) 18 Intel(R) 82801G (ICH7 Family) PCI Express Root Port - 27D4
- (PCI) 18 Intel(R) 82801G (ICH7 Family) USB Universal Host Controller - 27CA
- (PCI) 19 Intel(R) 82801G (ICH7 Family) USB Universal Host Controller - 27C9
- (PCI) 23 Intel(R) 82801G (ICH7 Family) USB Universal Host Controller - 27C8
- (PCI) 23 Intel(R) 82801G (ICH7 Family) USB2 Enhanced Host Controller - 27CC



## Appendix D <Programming GPIO's>

The GPIO can be programmed with the MSDOS debug program using simple IN/OUT commands. The following lines show an example how to do this.

GPIO0.....GPIO7 bit0.....bit7

```
-o 2E 87                ;enter configuration
-o 2E 87
-o 2E 07
-o 2F 09                ;enable GPIO function
-o 2E 30
-o 2F 02                ;enable GPIO configuration
-o 2E F0
-o 2F xx                ;set GPIO as input/output; set '1' for input,'0' for
output
-o 2E F1
-o 2F xx                ;if set GPIO's as output,in this register its value
can be set
```

Optional :

```
-o 2E F2
-o 2F xx                ; Data inversion register ; '1' inverts the current
                        ; value of the bits , '0' leaves them as they are
-o 2E 30
-o 2F 01                ; active GPIO's
```

For further information, please refer to Winbond W83627DHG datasheet.

## Appendix E <Programming Watchdog Timer >

The watchdog timer makes the system auto-reset while it stops to work for a period.

The integrated watchdog timer can be setup as system reset mode by program.

### Timeout Value Range

- 1 to 255
- Second or Minute

### Program Sample

Watchdog timer setup as system reset with 5 second of timeout

```

2E, 87
2E, 87
2E, 07
2F, 08      Logical Device 8
2E, 30      Activate
2F, 01
2E, F5      Set as Second*
2F, 00
2E, F6      Set as 5
2F, 05
    
```

\* Minute: bit 3 = 0; Second: bit 3 = 1

You can select Timer setting in the BIOS, after setting the time options, the system will reset according to the period of your selection.



Any advice or comments about our products and service, or anything we can help you with please don't hesitate to contact with us. We will do our best to support you for your products, projects and business.

## **Global American Inc.**

Address: 17 Hampshire Drive  
Hudson, NH 03051

TEL: Toll Free (U.S. Only) 800-833-8999  
(603)886-3900

FAX: (603)886-4545

Website: <http://www.globalamericaninc.com>

E-Mail: [salesinfo@globalamericaninc.com](mailto:salesinfo@globalamericaninc.com)

