



IMB-180

# User Manual

Version 1.0

Published July 2013

Copyright©2013 ASRock INC. All rights reserved.

---

Version 1.0

Published June 2013

Copyright©2013 ASRock INC. All rights reserved.

### Copyright Notice:

No part of this documentation may be reproduced, transcribed, transmitted, or translated in any language, in any form or by any means, except duplication of documentation by the purchaser for backup purpose, without written consent of ASRock Inc.

Products and corporate names appearing in this documentation may or may not be registered trademarks or copyrights of their respective companies, and are used only for identification or explanation and to the owners' benefit, without intent to infringe.

### Disclaimer:

Specifications and information contained in this documentation are furnished for informational use only and subject to change without notice, and should not be constructed as a commitment by ASRock. ASRock assumes no responsibility for any errors or omissions that may appear in this documentation.

With respect to the contents of this documentation, ASRock does not provide warranty of any kind, either expressed or implied, including but not limited to the implied warranties or conditions of merchantability or fitness for a particular purpose.

In no event shall ASRock, its directors, officers, employees, or agents be liable for any indirect, special, incidental, or consequential damages (including damages for loss of profits, loss of business, loss of data, interruption of business and the like), even if ASRock has been advised of the possibility of such damages arising from any defect or error in the documentation or product.

The terms HDMI™ and HDMI High-Definition Multimedia Interface, and the HDMI logo are trademarks or registered trademarks of HDMI Licensing LLC in the United States and other countries.



This device complies with Part 15 of the FCC Rules. Operation is subject to the following two conditions:

- (1) this device may not cause harmful interference, and
- (2) this device must accept any interference received, including interference that may cause undesired operation.

### CALIFORNIA, USA ONLY

The Lithium battery adopted on this motherboard contains Perchlorate, a toxic substance controlled in Perchlorate Best Management Practices (BMP) regulations passed by the California Legislature. When you discard the Lithium battery in California, USA, please follow the related regulations in advance.

“Perchlorate Material-special handling may apply, see [www.dtsc.ca.gov/hazardouswaste/perchlorate](http://www.dtsc.ca.gov/hazardouswaste/perchlorate)”

**ASRock Website:** <http://www.asrock.com>

---

---

# Contents

<b>1</b>	<b>Introduction .....</b>	<b>5</b>
1.1	Package Contents .....	5
1.2	Specifications.....	6
1.3	Motherboard Layout.....	8
1.4	I/O Panel.....	10
<b>2</b>	<b>Installation .....</b>	<b>11</b>
2.1	Screw Holes.....	11
2.2	Pre-installation Precautions.....	11
2.3	Installation of Memory Modules (DIMM).....	12
2.4	Expansion Slots .....	13
2.5	Jumpers Setup.....	15
2.6	Onboard Headers and Connectors.....	16
2.7	Driver Installation Guide .....	21
<b>3</b>	<b>UEFI SETUP UTILITY.....</b>	<b>22</b>
3.1	Introduction.....	22
3.1.1	UEFI Menu Bar .....	22
3.1.2	Navigation Keys .....	23
3.2	Main Screen.....	23
3.3	Advanced Screen.....	24
3.3.1	CPU Configuration .....	25
3.3.2	Chipset Configuration.....	27
3.3.3	Storage Configuration .....	29
3.3.4	Intel(R) Rapid Start Technology .....	30
3.3.5	Intel(R) Smart Connect Technology .....	31
3.3.6	AMT Configuration .....	32
3.3.7	Super IO Configuration .....	34
3.3.8	ACPI Configuration.....	35
3.3.9	USB Configuration .....	36
3.3.10	Voltage Configuration.....	37
3.4	Hardware Health Event Monitoring Screen .....	38
3.5	Boot Screen.....	39
3.6	Security Screen .....	41
3.7	Exit Screen .....	42

---

<b>4 Software Support .....</b>	<b>43</b>
4.1 Install Operating System.....	43
4.2 Support CD Information .....	43
4.2.1 Running Support CD.....	43
4.2.2 Drivers Menu.....	43
4.2.3 Utilities Menu.....	43
4.2.4 Contact Information.....	43

---

# Chapter 1: Introduction

Thank you for purchasing ASRock **IMB-180** motherboard, a reliable motherboard produced under ASRock's consistently stringent quality control. It delivers excellent performance with robust design conforming to ASRock's commitment to quality and endurance.

In this manual, chapter 1 and 2 contain introduction of the motherboard and step-by-step guide to the hardware installation. Chapter 3 and 4 contain the configuration guide to BIOS setup and information of the Support CD.



Because the motherboard specifications and the BIOS software might be updated, the content of this manual will be subject to change without notice. In case any modifications of this manual occur, the updated version will be available on ASRock website without further notice. You may find the latest VGA cards and CPU support lists on ASRock website as well. ASRock website <http://www.asrock.com>

If you require technical support related to this motherboard, please visit our website for specific information about the model you are using. [www.asrock.com/support/index.asp](http://www.asrock.com/support/index.asp)

## 1.1 Package Contents

ASRock **IMB-180** Motherboard

(Mini-ITX Form Factor: 6.7-in x 6.7-in, 17.0 cm x 17.0 cm)

ASRock **IMB-180** Driver CD

ASRock **IMB-180** Jumper setting instruction

1 x I/O Panel Shield

## 1.2 Specifications

<b>Form Factor</b>	Dimensions	Mini-ITX (6.7-in x 6.7-in)
<b>Processor System</b>	CPU	Socket rPGA947 for Intel® Core i7/i5/i3/mobile processor (Haswell)
	Core Number	(By CPU, Max 4)
	Max Speed	(By CPU)
	L3 Cache	(By CPU)
	Chipset	QM87
	BIOS	UEFI
<b>Expansion Slot</b>	PCI	0
	Mini-PCIe	1 (Full size)
	mSATA	1 (Full size)
	PCIe	1 (x16) with Riser card extend to x8+x8 or x8+x4+x4
	CFast Card Socket	0
<b>Memory</b>	Technology	Dual Channel DDR3 1066/1333/1600 MHz SDRAM
	Max.	16GB
	Socket	2 x SO-DIMM
<b>Graphics</b>	Controller	Intel® HD Graphics (By CPU)
	VRAM	Shared Memory
	VGA	Supports max resolution 1920x1200
	LVDS	1
	HDMI	Supports HDMI 1.4a, max resolution 4096x2304
	DVI	No
	DisplayPort	Supports max resolution 3840x2160
	Multi Display	Yes (Three Display)
<b>Ethernet</b>	Ethernet	10/100/1000 Mbps
	Controller	GbE LAN1: Intel® I210, LAN2: Intel® I217LM (with v-Pro support)
	Connector	2 x RJ-45
<b>SATA</b>	Max Data Transfer Rate	SATA2 (3.0Gb/S), SATA3 (6.0Gb/S), Supports RAID 0/1/5/10
<b>Rear I/O</b>	VGA	1
	DVI	0
	HDMI	1

	DisplayPort	2
	Ethernet	2
	USB	4 x USB 3.0 compliant
	Audio	2 (Mic-In, Line-Out)
	Serial	2 (RS-232/422/485)
	PS/2	0
<b>Internal Connector</b>	USB	- 8 (4 x USB Header 2.54mm pitch) - 1 Vertical Type A USB Connector
	LVDS/ Inverter	24 bit dual channel LVDS
	VGA	0
	Serial	4 (RS-232)
	SATA	4 x SATA3 (6.0Gb/s), Support RAID 0/1/5/10
	mPCIe	1
	Parallel	1
	mSATA	1
	IrDA	0
	GPIO 8-bit	4 x GPI + 4 x GPO
	SATA PWR Output Con	1
	Speaker Header	0
<b>Watchdog Timer</b>	Output	Output from super I/O to drag RESETCON#
	Interval	256 Segments, 0,1,2...255 Sec/Min
<b>Power Requirements</b>	Input PWR	DC-in 12V~19V
	Power On	AT/ATX Supported -AT : Directly PWR on as power input ready -ATX : Press button to PWR on after power input ready
<b>Environment</b>	Temperature	0°C – 60°C

### 1.3 Motherboard Layout

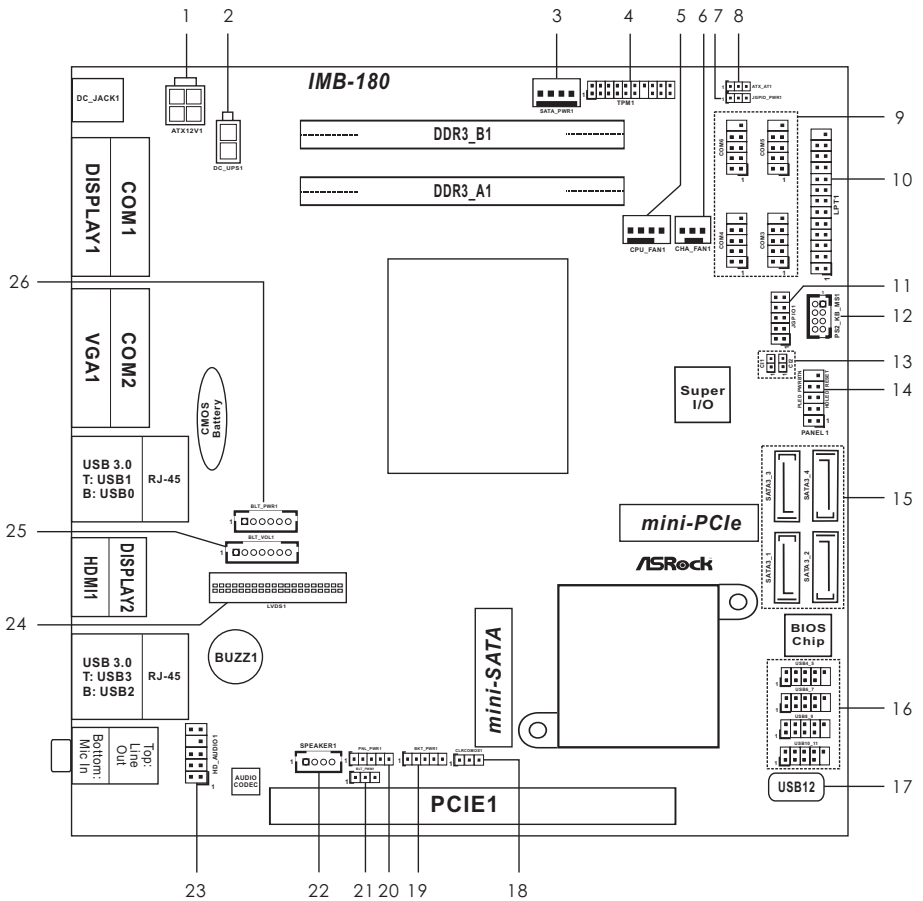



- 
- 1 : ATX Power Connector**
  - 2 : 2-pin UPS Module Power Input Connector**
  - 3 : SATA Power Output Connector**
  - 4 : TPM Header**
  - 5 : 4-Pin CPU FAN Connector**
  - 6 : 3-Pin Chassis FAN Connector**
  - 7 : Digital Input / Output Power Select**
  - 8 : ATX/AT Mode Jumper**
  - 9 : RS-232 Port 4 Pin Headers**
  - 10 : Printer Port Header**
  - 11 : Digital Input / Output Pin Header**
  - 12 : PS2\_KB\_MS1 Header**
  - 13 : Chassis Intrusion Headers**
  - 14 : System Panel Header**
  - 15 : SATA3 Connectors**
  - 16 : USB2.0 Connectors**
  - 17 : USB2.0 Port (USB12)**
  - 18 : Clear CMOS Header**
  - 19 : BKT\_PWR1 Header**
  - 20 : PNL\_PWR1 Header**
  - 21 : BLT\_PWM1 Header**
  - 22 : 3W Audio AMP Output Wafer**
  - 23 : Front Panel Audio Header**
  - 24 : LVDS Panel Connector**
  - 25 : Backlight Volume Control**
  - 26 : Backlight Power Connector**

## 1.4 I/O Panel

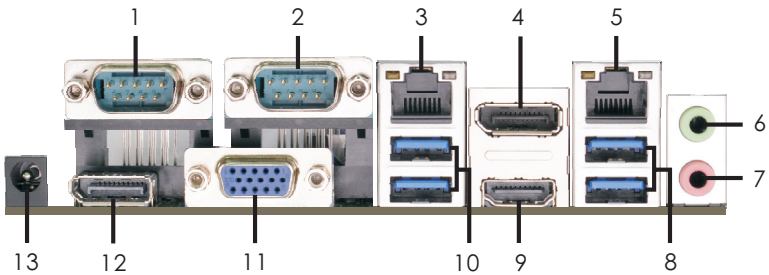

- |     |                       |    |                        |
|-----|-----------------------|----|------------------------|
| 1   | COM Port (COM1)       | 8  | USB 3.0 Ports (USB_23) |
| 2   | COM Port (COM2)       | 9  | HDMI Port (HDMI1)      |
| * 3 | LAN RJ-45 Port (LAN1) | 10 | USB 3.0 Ports (USB_01) |
| 4   | DisplayPort (DP2)     | 11 | VGA Port (VGA1)        |
| * 5 | LAN RJ-45 Port (LAN2) | 12 | DisplayPort (DP1)      |
| 6   | Line out (Lime)       | 13 | DC Jack (DC_JACK1)     |
| 7   | Microphone (Pink)     |    |                        |

\* There are two LED next to the LAN port. Please refer to the table below for the LAN port LED indications.

### LAN Port LED Indications

Activity/Link LED	
Status	Description
Off	No Link
Blinking	Data Activity
On	Link

SPEED LED	
Status	Description
Off	10Mbps connection
Orange	100Mbps connection
Green	1Gbps connection

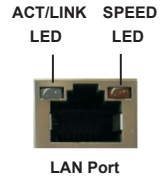

---

## Chapter 2: Installation

This is a Mini-ITX form factor (6.7" x 6.7", 17.0 x 17.0 cm) motherboard. Before you install the motherboard, study the configuration of your chassis to ensure that the motherboard fits into it.



Make sure to unplug the power cord before installing or removing the motherboard. Failure to do so may cause physical injuries to you and damages to motherboard components.

### 2.1 Screw Holes

Place screws into the holes to secure the motherboard to the chassis.



Do not over-tighten the screws! Doing so may damage the motherboard.

### 2.2 Pre-installation Precautions

Take note of the following precautions before you install motherboard components or change any motherboard settings.

1. Unplug the power cord from the wall socket before touching any component.
2. To avoid damaging the motherboard components due to static electricity, NEVER place your motherboard directly on the carpet or the like. Also remember to use a grounded wrist strap or touch a safety grounded object before you handle components.
3. Hold components by the edges and do not touch the ICs.
4. Whenever you uninstall any component, place it on a grounded antistatic pad or in the bag that comes with the component.



Before you install or remove any component, ensure that the power is switched off or the power cord is detached from the power supply. Failure to do so may cause severe damage to the motherboard, peripherals, and/or components.

---

## 2.3 Installation of Memory Modules (SO-DIMM)

This motherboard provides two 204-pin DDR3 (Double Data Rate 3) SO-DIMM slots.



It is not allowed to install a DDR or DDR2 memory module into DDR3 slot; otherwise, this motherboard and SO-DIMM may be damaged.

### Installing a SO-DIMM



Please make sure to disconnect power supply before adding or removing SO-DIMMs or the system components.

- Step 1. Unlock a SO-DIMM slot by pressing the retaining clips outward.
- Step 2. Align a SO-DIMM on the slot such that the notch on the SO-DIMM matches the break on the slot.

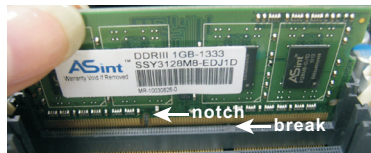
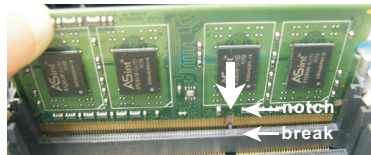

The SO-DIMM only fits in one correct orientation. It will cause permanent damage to the motherboard and the SO-DIMM if you force the SO-DIMM into the slot at incorrect orientation.

- Step 3. Firmly insert the SO-DIMM into the slot until the retaining clips at both ends fully snap back in place and the SO-DIMM is properly seated.

## 2.4 Expansion Slots (PCI Express, mini-PCIe and mini-SATA Slots)

There is 1 PCI Express slot, 1 mini-PCIe slot and 1 mini-SATA slot on this motherboard.

**PCIe slot:** PCIe1 (PCIe x16 slot; Blue) is used for PCI Express x16 lane width graphics cards.



Pin	Side B	Side A
1	+12V	PRSNT#
2	+12V	+12V
3	+12V	+12V
4	Ground	Ground
5	SMCLK	PCH_ECLK_X8
6	SMDAT	PCH_ECLK_X8#
7	Ground	PCH_ECLK_X4
8	+3.3V	PCH_ECLK_X4#
9	Reserved	+3.3V
10	+3VSB	+3.3V
11	WAKE#	PCIE_RESET#
12	X8_PRSNT#	Ground
13	Ground	PCH_ECLK_X16
14	HSOP0	PCH_ECLK_X16#
15	HSON0	Ground
16	Ground	HSIP0
17	PRSNT#1	HSIP0
18	Ground	Ground
19	HSOP1	Reserved
20	HSON1	Ground
21	Ground	HSIP1
22	Ground	HSIP1
23	HSOP2	Ground
24	HSOP2	Ground
25	Ground	HSIP2
26	Ground	HSIP2
27	HSOP3	Ground
28	HSOP3	Ground
29	Ground	HSIP3
30	X4_PRSNT#	HSIP3
31	PRSNT#2	Ground
32	Ground	Reserved
33	HSOP4	Reserved
34	HSOP4	Ground
35	Ground	HSIP4
36	Ground	HSIP4
37	HSOP5	Ground
38	HSOP5	Ground
39	Ground	HSIP5
40	Ground	HSIP5
41	HSOP6	Ground

Pin	Side B	Side A
42	HSOP6	Ground
43	Ground	HSIP6
44	Ground	HSIP6
45	HSOP7	Ground
46	HSOP7	Ground
47	Ground	HSIP7
48	PRSNT#3	HSIP7
49	Ground	Ground
50	HSOP8	Reserved
51	HSOP8	Ground
52	Ground	HSIP8
53	Ground	HSIP8
54	HSOP9	Ground
55	HSOP9	Ground
56	Ground	HSIP9
57	Ground	HSIP9
58	HSOP10	Ground
59	HSOP10	Ground
60	Ground	HSIP10
61	Ground	HSIP10
62	HSOP11	Ground
63	HSOP11	Ground
64	Ground	HSIP11
65	Ground	HSIP11
66	HSOP12	Ground
67	HSOP12	Ground
68	Ground	HSIP12
69	Ground	HSIP12
70	HSOP13	Ground
71	HSOP13	Ground
72	Ground	HSIP13
73	Ground	HSIP13
74	HSOP14	Ground
75	HSOP14	Ground
76	Ground	HSIP14
77	Ground	HSIP14
78	HSOP15	Ground
79	HSOP15	Ground
80	Ground	HSIP15
81	PRSNT#4	HSIP15
82	Reserved	Ground

---

### Support X8X8 Riser Card

Slot	Starpping Pin	Clock Source
Slot1 X8	Riser card side B12 pin to GND	A13 & A14
Slot2 X8		A5 & A6

### Support X8X4X4 Riser Card

Slot	Starpping Pin	Clock Source
Slot1 X8	Riser card side B30 pin to GND	A13 & A14
Slot2 X4		A5 & A6
Slot3 X4		A7 & A8

#### mini-PCIe slot:

MINI\_PCIE1 (mini-PCIe slot) is used for PCI Express mini cards.

#### mini-SATA slot:

MSATA1 (mini-SATA slot) is used for mSATA cards.



### Installing an expansion card

- Step 1. Before installing the expansion card, please make sure that the power supply is switched off or the power cord is unplugged. Please read the documentation of the expansion card and make necessary hardware settings for the card before you start the installation.
- Step 2. Remove the system unit cover (if your motherboard is already installed in a chassis).
- Step 3. Remove the bracket facing the slot that you intend to use. Keep the screws for later use.
- Step 4. Align the card connector with the slot and press firmly until the card is completely seated on the slot.
- Step 5. Fasten the card to the chassis with screws.
- Step 6. Replace the system cover.



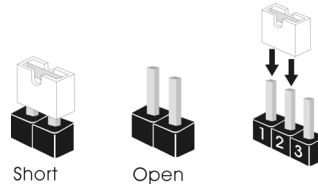

## 2.5 Jumpers Setup

The illustration shows how jumpers are setup. When the jumper cap is placed on pins, the jumper is “Short”. If no jumper cap is placed on pins, the jumper is “Open”. The illustration shows a 3-pin jumper whose pin1 and pin2 are “Short” when jumper cap is placed on these 2 pins.



Jumper	Setting	Description
Clear CMOS Jumper (3-pin CLRCMOS1) (see p.8, No. 18)	<div style="display: flex; justify-content: space-around;"> <div style="text-align: center;"> <p><b>1_2</b></p>  <p>Default</p> </div> <div style="text-align: center;"> <p><b>2_3</b></p>  <p>Clear CMOS</p> </div> </div>	

Note: CLRCMOS1 allows you to clear the data in CMOS. To clear and reset the system parameters to default setup, please turn off the computer and unplug the power cord from the power supply. After waiting for 15 seconds, use a jumper cap to short pin2 and pin3 on CLRCMOS1 for 5 seconds. However, please do not clear the CMOS right after you update the BIOS. If you need to clear the CMOS when you just finish updating the BIOS, you must boot up the system first, and then shut it down before you do the clear-CMOS action. Please be noted that the password, date, time, user default profile and MAC address will be cleared only if the CMOS battery is removed.

Panel Power Selection (5-pin PNL_PWR1) (see p.8, No. 20)	1 	1-2 : LVDD: +3V 2-3 : LVDD: +5V 4-5 : LVDD: +12V
Backlight Power Selection (5-pin BKT_PWR1) (see p.8, No. 19)	1 	1-2: LCD_BLT_VCC: +5V 2-3: LCD_BLT_VCC: +12V 4-5: LCD_BLT_VCC: DC_IN
ATX/AT Mode Selection (3-pin PWR_JP1) (see p.8, No. 8)	 1 2 3	1-2 : AT Mode 2-3 : ATX Mode
BLT_PWM1 (3-pin BLT_PWM1) (see p.8, No. 21)	 1 2 3	1-2 : +3V Level 2-3 : +5V Level
Digital Input / Output Power select (3-pin JGPIO_PWR1) (see p.8, No. 7)	 1 2 3	1-2 : +12V 2-3 : +5V

## 2.6 Onboard Headers and Connectors



Onboard headers and connectors are NOT jumpers. Do NOT place jumper caps over these headers and connectors. Placing jumper caps over the headers and connectors will cause permanent damage of the motherboard!

### LVDS Panel Connector

(40-pin LVDS1)  
(see p.8, No. 24)

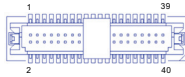

PIN	Signal Name	PIN	Signal Name
1	LVDD	2	LVDD
3	+3V	4	N/A
5	N/A	6	LVDS_A_DATA0#
7	LVDS_A_DATA0	8	GND1
9	LVDS_A_DATA1#	10	LVDS_A_DATA1
11	GND6	12	LVDS_A_DATA2#
13	LVDS_A_DATA2	14	GND2
15	LVDS_A_DATA3#	16	LVDS_A_DATA3
17	GND7	18	LVDS_A_CLK#
19	LVDS_A_CLK	20	GND3
21	LVDS_B_DATA0#	22	LVDS_B_DATA0
23	GND8	24	LVDS_B_DATA1#
25	LVDS_B_DATA1	26	GND4
27	LVDS_B_DATA2#	28	LVDS_B_DATA2
29	DPLVDD_EN	30	LVDS_B_DATA3#
31	LVDS_B_DATA3	32	GND5
33	LVDS_B_CLK#	34	LVDS_B_CLK
35	GND9	36	CON_LBKLT_EN_R
37	CON_LBKLT_CTR_R	38	LCD_BLT_VCC
39	LCD_BLT_VCC	40	LCD_BLT_VCC

### Backlight Power Connector

(6-pin BLT\_PWR1)  
(see p.8, No. 26)



PIN	Signal Name
1	GND
2	GND
3	BL CTL
4	BL EN
5	LCD_BLT_VCC
6	LCD_BLT_VCC

### Backlight Volume Control

(7-pin BLT\_VOL1)  
(see p.8, No. 25)



PIN	Signal Name
1	GPIO_VOL_UP
2	GPIO_VOL_DW
3	PWRDN
4	LVDS1 BLUP
5	LVDS1 BLDW
6	GND
7	GND



### CPU Fan Connector

(4-pin CPU\_FAN1)

(see p.8 No. 5)

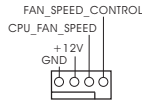

Please connect the CPU fan cable to the connector and match the black wire to the ground pin.



Though this motherboard provides 4-Pin CPU fan (Quiet Fan) support, the 3-Pin CPU fan still can work successfully even without the fan speed control function. If you plan to connect the 3-Pin CPU fan to the CPU fan connector on this motherboard, please connect it to Pin 1-3.

Pin 1-3 Connected ←



3-Pin Fan Installation

### Chassis Fan Connector

(3-pin CHA\_FAN1)

(see p.8, No. 6)

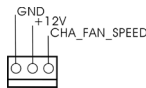

Please connect the fan cable to the fan connector and match the black wire to the ground pin.

### RS-232 Port 4 Pin Headers

(9-pin COM3/COM4/COM5/COM6:

see p.8, No. 9)

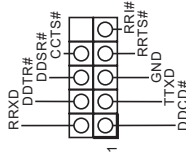

### UPS Module Power Input Connector

(2-pin DC\_UPS1)

(see p.8, No. 2)



### SATA Power Output Connector

(4-pin SATA\_PWR1)

(see p.8, No. 3)

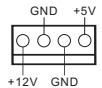

### Digital Input / Output Pin Header

(10-pin JGPIO1)

(see p.8, No. 11)

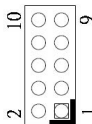

PIN	Signal Name	PIN	Signal Name
10	GND	9	JGPIO_PWR1
8	SIO_GP23	7	SIO_GP27
6	SIO_GP22	5	SIO_GP26
4	SIO_GP21	3	SIO_GP25
2	SIO_GP20	1	SIO_GP24

---

## System Panel Header

(9-pin PANEL1)

(see p.8, No. 14)

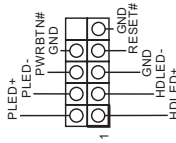

This header accommodates several system front panel functions.



Connect the power switch, reset switch and system status indicator on the chassis to this header according to the pin assignments below. Note the positive and negative pins before connecting the cables.

### **PWRBTN (Power Switch):**

Connect to the power switch on the chassis front panel. You may configure the way to turn off your system using the power switch.

### **RESET (Reset Switch):**

Connect to the reset switch on the chassis front panel. Press the reset switch to restart the computer if the computer freezes and fails to perform a normal restart.

### **PLED (System Power LED):**

Connect to the power status indicator on the chassis front panel. The LED is on when the system is operating. The LED keeps blinking when the system is in S1/S3 sleep state. The LED is off when the system is in S4 sleep state or powered off (S5).

### **HDLED (Hard Drive Activity LED):**

Connect to the hard drive activity LED on the chassis front panel. The LED is on when the hard drive is reading or writing data.

The front panel design may differ by chassis. A front panel module mainly consists of power switch, reset switch, power LED, hard drive activity LED, speaker and etc. When connecting your chassis front panel module to this header, make sure the wire assignments and the pin assignments are matched correctly.

---

## SATA3 Connectors

(SATA3\_1/SATA3\_2/SATA3\_3/SATA3\_4:

see p.8, No. 15)



These four Serial ATA3 (SATA3) connectors support SATA data cables for internal storage devices. The current SATA3 interface allows up to 6.0 Gb/s data transfer rate.

## USB 2.0 Headers

(9-pin USB4\_5/USB6\_7/USB8\_9/USB10\_11: see p.8, No. 16)

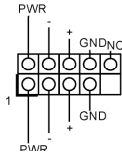

(USB12: see p.8, No. 17)



There are four USB 2.0 headers and one port on this motherboard. Each USB 2.0 header can support two USB 2.0 ports.

## Chassis Intrusion Headers

(2-pin C11/C12: see p.8, No. 13)



This motherboard supports CASE OPEN detection feature that detects if the chassis cover has been removed. This feature requires a chassis with chassis intrusion detection design.

C11:

Close: Active case open

Open: Normal

C12:

Close: Normal

Open: Active case open

## Front Panel Audio Header

(9-pin HD\_AUDIO1)

(see p.8 No. 23)

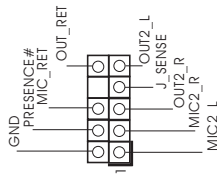

This is an interface for front panel audio cable that allows convenient connection and control of audio devices.

## 3W Audio Amp Output Wafer

(4-pin SPEAKER1)

(see p.8, No. 22)



PIN	Signal Name
1	SPK R-
2	SPK R+
3	SPK L+
4	SPK L-

### ATX Power Connector (Input 9V-19V)

(4-pin ATX12V1)

(see p.8, No. 1)

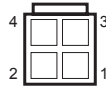

Please connect an ATX 12V power supply to this connector.

1-2: GND

3-4: DC Input

### TPM Header

(19-pin TPM1)

(see p.8, No. 4)

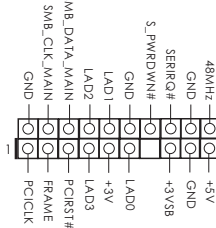

This connector supports a Trusted Platform Module (TPM) system, which can securely store keys, digital certificates, passwords, and data. A TPM system also helps enhance network security, protects digital identities, and ensures platform integrity.

### PS2\_KB\_MS1

(8-pin PS2\_KB\_MS1)

(see p.8, No. 12)



PIN	Signal Name
1	KBCLK
2	+5V
3	KBDATA
4	+5V
5	MSDATA
6	GND
7	MSCLK
8	GND

### Print Port Header

(25-pin LPT1)

(see p.8, No. 12)

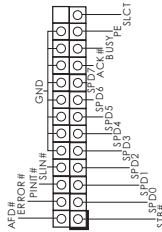

This is an interface for print port cable that allows convenient connection of printer devices.

---

## **2.7 Driver Installation Guide**

To install the drivers to your system, please insert the support CD to your optical drive first. Then, the drivers compatible to your system can be auto-detected and listed on the support CD driver page. Please follow the order from top to bottom to install those required drivers. Therefore, the drivers you install can work properly.

---

## Chapter 3: UEFI SETUP UTILITY

### 3.1 Introduction

This section explains how to use the UEFI SETUP UTILITY to configure your system. The UEFI chip on the motherboard stores the UEFI SETUP UTILITY. You may run the UEFI SETUP UTILITY when you start up the computer. Please press <F2> or <Del> during the Power-On-Self-Test (POST) to enter the UEFI SETUP UTILITY, otherwise, POST will continue with its test routines.

If you wish to enter the UEFI SETUP UTILITY after POST, restart the system by pressing <Ctl> + <Alt> + <Delete>, or by pressing the reset button on the system chassis. You may also restart by turning the system off and then back on.



Because the UEFI software is constantly being updated, the following UEFI setup screens and descriptions are for reference purpose only, and they may not exactly match what you see on your screen.

#### 3.1.1 UEFI Menu Bar

The top of the screen has a menu bar with the following selections:

<b>Main</b>	To set up the system time/date information
<b>Advanced</b>	To set up the advanced UEFI features
<b>H/W Monitor</b>	To display current hardware status
<b>Boot</b>	To set up the default system device to locate and load the Operating System
<b>Security</b>	To set up the security features
<b>Exit</b>	To exit the current screen or the UEFI SETUP UTILITY

Use <←> key or <→> key to choose among the selections on the menu bar, and then press <Enter> to get into the sub screen. You can also use the mouse to click your required item.

### 3.1.2 Navigation Keys

Please check the following table for the function description of each navigation key.

Navigation Key(s)	Function Description
← / →	Moves cursor left or right to select Screens
↑ / ↓	Moves cursor up or down to select items
+ / -	To change option for the selected items
<Enter>	To bring up the selected screen
<F1>	To display the General Help Screen
<F7>	Discard changes
<F9>	To load optimal default values for all the settings
<F10>	To save changes and exit the UEFI SETUP UTILITY
<F12>	Print screen
<ESC>	To jump to the Exit Screen or exit the current screen

### 3.2 Main Screen

When you enter the UEFI SETUP UTILITY, the Main screen will appear and display the system overview.

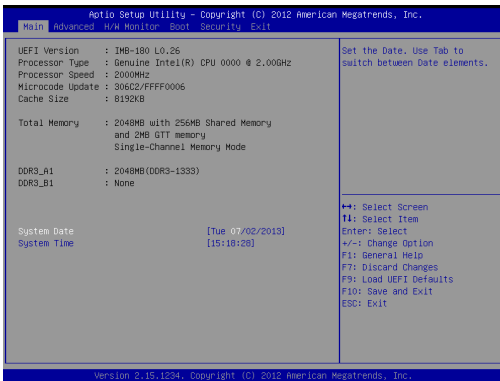

---

### 3.3 Advanced Screen

In this section, you may set the configurations for the following items: CPU Configuration, Chipset Configuration, Storage Configuration, Intel(R) Rapid Start Technology, Intel(R) Smart Connect Technology, AMT Configuration, Super IO Configuration, ACPI Configuration, USB Configuration and Voltage Configuration.



Setting wrong values in this section may cause the system to malfunction.

#### Instant Flash

Instant Flash is a UEFI flash utility embedded in Flash ROM. This convenient UEFI update tool allows you to update system UEFI without entering operating systems first like MS-DOS or Windows®. Just launch this tool and save the new UEFI file to your USB flash drive, floppy disk or hard drive, then you can update your UEFI only in a few clicks without preparing an additional floppy diskette or other complicated flash utility. Please be noted that the USB flash drive or hard drive must use FAT32/16/12 file system. If you execute Instant Flash utility, the utility will show the UEFI files and their respective information. Select the proper UEFI file to update your UEFI, and reboot your system after UEFI update process completes.



---

### 3.3.1 CPU Configuration



#### Intel Hyper Threading Technology

Intel Hyper Threading Technology allows multiple threads to run on each core, so that the overall performance on threaded software is improved.

#### Active Processor Cores

Select the number of cores to enable in each processor package.

#### CPU C States Support

Enable CPU C States Support for power saving. It is recommended to keep C3, C6 and C7 all enabled for better power saving.

#### Enhanced Halt State (C1E)

Enable Enhanced Halt State (C1E) for lower power consumption.

#### CPU C3 State Support

Enable C3 sleep state for lower power consumption.

#### CPU C6 State Support

Enable C6 deep sleep state for lower power consumption.

#### CPU C7 State Support

Enable C7 deep sleep state for lower power consumption.

#### Package C State Support

Enable CPU, PCIe, Memory, Graphics C State Support for power saving.

#### Intel SpeedStep Technology

Intel SpeedStep technology is Intel's new power saving technology. Processors can switch between multiple frequencies and voltage points to enable power saving. The default value is [Enabled]. Configuration options: [Enabled] and [Disabled]. If you install Windows® 7 / 8 and want to enable this function, please set this item to [Enabled]. This item will be hidden if the current CPU does not support Intel SpeedStep technology.



Please note that enabling this function may reduce CPU voltage and lead to system stability or compatibility issues with some power supplies. Please set this item to [Disabled] if above issues occur.

### **Intel Turbo Boost Technology**

Use this item to enable or disable Intel Turbo Boost Mode Technology. Turbo Boost Mode allows processor cores to run faster than marked frequency in specific conditions. The default value is [Enabled].

### **CPU Thermal Throttling**

You may select [Enabled] to enable CPU internal thermal control mechanism to keep the CPU from overheating.

### **No-Execute Memory Protection**

No-Execution (NX) Memory Protection Technology is an enhancement to the IA-32 Intel Architecture. An IA-32 processor with “No Execute (NX) Memory Protection” can prevent data pages from being used by malicious software to execute codes. This option will be hidden if the current CPU does not support No-Execute Memory Protection.

### **Intel Virtualization Technology**

When this option is set to [Enabled], a VMM (Virtual Machine Architecture) can utilize the additional hardware capabilities provided by Vanderpool Technology. This option will be hidden if the installed CPU does not support Intel Virtualization Technology.

### **Hardware Prefetcher**

Use this item to turn on/off the MLC streamer prefetcher.

### **Adjacent Cache Line Prefetch**

Use this item to turn on/off prefetching of adjacent cache lines.

---

## 3.3.2 Chipset Configuration

The screenshot shows the 'Advanced' menu of the BIOS Setup Utility. The title bar reads 'Auto Setup Utility - Copyright (C) 2012 American Megatrends, Inc.' and the bottom bar reads 'Version 3.15.1234, Copyright (C) 2012 American Megatrends, Inc.' The menu is divided into two columns. The left column lists various settings, and the right column provides instructions for the 'VT-d' setting.

Setting	Value	Instructions
VT-d Capability	Supported	If [Auto] is selected, the motherboard will detect the memory module(s) inserted and assign the appropriate frequency automatically.
DRAM Frequency	[Auto]	
Primary Graphics Adapter	[PCI Express]	
VT-d	[Disabled]	
PCIe Link Speed	[Auto]	
Share Memory	[Auto]	
IGPU Multi-Monitor	[Disabled]	
Render Standby	[Enabled]	
Onboard HD Audio	[Enabled]	
Front Panel	[Auto]	→: Select Screen
Onboard HDMI HD Audio	[Enabled]	F4: Select Item
Onboard LAN1	[Enabled]	Enter: Select
Onboard LAN2	[Enabled]	+/-: Change Option
Deep Sleep	[Disabled]	F2: General Help
Restore on AC/Power Loss	[Power Off]	F7: Discard Changes
Active LVDS	[Enabled]	F9: Load UEFI Defaults
Panel Type Selection	[1440x900/24-bit/2-c...]	F10: Save and Exit
Primary IGFX Boot Display	[VBDS Default]	Esc: Exit

### DRAM Frequency

If [Auto] is selected, the motherboard will detect the memory module(s) inserted and assign the appropriate frequency automatically.

### Primary Graphics Adapter

This allows you to select [Onboard] or [PCI Express] as the boot graphic adapter priority. The default value is [PCI Express].

### VT-d

Use this to enable or disable Intel® VT-d technology (Intel® Virtualization Technology for Directed I/O). The default value of this feature is [Disabled].

### PCIe Link Speed

Select the link speed for PCIe1.

### Share Memory

Configure the size of memory that is allocated to the integrated graphics processor when the system boots up.

### IGPU Multi-Monitor

Select disable to disable the integrated graphics when an external graphics card is installed. Select enable to keep the integrated graphics enabled at all times.

### Render Standby

Use this to enable or disable Render Standby by Internal Graphics Device. The default value is [Enabled].

### Onboard HD Audio

Select [Auto], [Enabled] or [Disabled] for the onboard HD Audio feature. If you select [Auto], the onboard HD Audio will be disabled when PCI Sound Card is plugged.

---

**Front Panel**

Select [Auto] or [Disabled] for the onboard HD Audio Front Panel.

**Onboard HDMI HD Audio**

This allows you to enable or disable the Onboard HDMI HD Audio feature.

**Onboard LAN1**

This allows you to enable or disable the Onboard LAN1 feature.

**Onboard LAN2**

This allows you to enable or disable the Onboard LAN2 feature.

**Deep Sleep**

Mobile platforms support Deep S4/S5 in DC only and desktop platforms support Deep S4/S5 in AC only. The default value is [Disabled].

**Restore on AC/Power Loss**

This allows you to set the power state after an unexpected AC/power loss. If [Power Off] is selected, the AC/power remains off when the power recovers. If [Power On] is selected, the AC/power resumes and the system starts to boot up when the power recovers.

**Active LVDS**

Use this to enable or disable the LVDS. The default value is [Enabled].

**Panel Type Selection**

Use this to select panel type.

**Primary IGFX Boot Display**

Select the Video Device which will be activated during POST. This has no effect if external graphics present. Secondary boot display selection will appear based on your selection. VGA modes will be supported only on primary display. Configuration options: [VBIOS Default], [CRT], [DVI], [HDMI] and [LVDS]. The default value is [VBIOS Default].

---

### 3.3.3 Storage Configuration

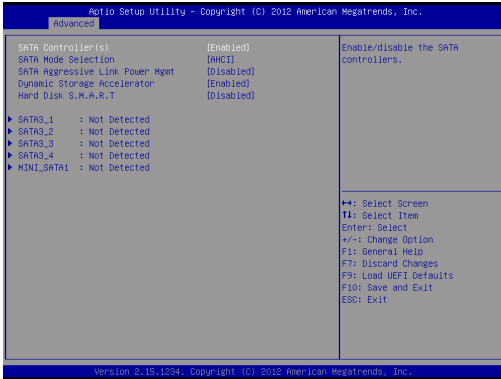

#### SATA Controller(s)

Use this item to enable or disable the SATA Controller feature.

#### SATA Mode Selection

Use this to select SATA mode. Configuration options: [IDE Mode], [AHCI Mode] and [RAID Mode]. The default value is [AHCI Mode].



AHCI (Advanced Host Controller Interface) supports NCQ and other new features that will improve SATA disk performance but IDE mode does not have these advantages.

#### SATA Aggressive Link Power Management

Use this item to configure SATA Aggressive Link Power Management.

#### Dynamic Storage Accelerator

Keep this option enabled for higher HDD and SSD I/O performance, lower latency and increased system responsiveness.

#### Hard Disk S.M.A.R.T.

Use this item to enable or disable the S.M.A.R.T. (Self-Monitoring, Analysis, and Reporting Technology) feature. Configuration options: [Disabled] and [Enabled].

---

### 3.3.4 Intel(R) Rapid Start Technology



#### Intel(R) Rapid Start Technology

Use this item to enable or disable Intel(R) Rapid Start Technology. Intel(R) Rapid Start Technology is a new zero power hibernation mode which allows users to resume in just 5-6 seconds. The default is [Disabled].

---

### 3.3.5 Intel(R) Smart Connect Technology

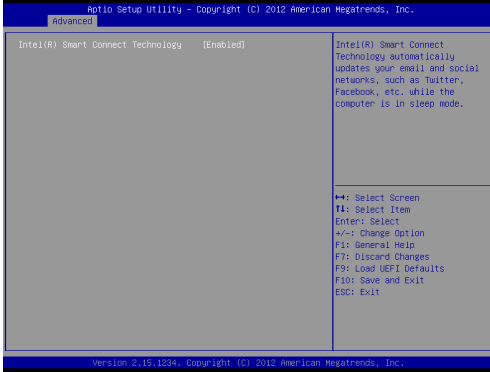

#### Intel(R) Smart Connect Technology

Use this item to enable or disable Intel(R) Smart Connect Technology. Intel(R) Smart Connect Technology keeps your e-mail and social networks, such as Twitter, Facebook, etc. updated automatically while the computer is in sleep mode. The default is [Enabled].

---

### 3.3.6 AMT Technology

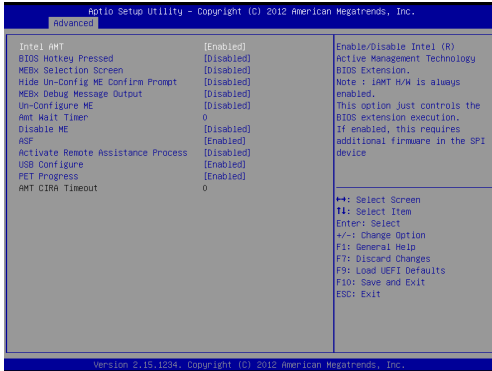

#### Intel AMT

Use this to enable or disable Intel(R) Active Management Technology BIOS Extension. The default is [Enabled].

#### BIOS Hotkey Pressed

Use this to enable or disable BIOS hotkey press. The default is [Disabled].

#### MEBx Selection Screen

Use this to enable or disable MEBx Selection Screen. The default is [Disabled].

#### Hide Un-Configure ME Confirmation

Hide Un-Configure ME without password confirmation prompt. The default is [Disabled].

#### MEBx Debug Message Output

Use this to enable or disable MEBx Debug Message Output. The default is [Disabled].

#### Un-Configure ME

Un-Configure ME without password. The default is [Disabled].

#### Amt Wait Timer

Set timer to wait before sending ASF\_GET\_BOOT\_OPTIONS.

#### Disable ME

Set ME to Soft Temporary Disabled. The default is [Disabled].

#### ASF

Use this to enable or disable Alert Specification Format. The default is [Enabled].

#### Activate Remote Assistance Process

Trigger CIRA boot. The default is [Disabled].

#### USB Configure

Use this to enable or disable USB Configure function. The default is [Enabled].



---

### **PET Progress**

User can enable or disable PET Events progress to receive PET events or not. The default is [Enabled].

---

### 3.3.7 Super IO Configuration

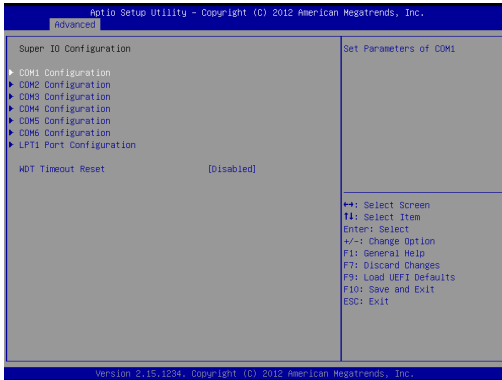

#### COM1 Configuration

Use this to set parameters of COM1.

#### COM2 Configuration

Use this to set parameters of COM2.

#### COM3 Configuration

Use this to set parameters of COM3.

#### COM4 Configuration

Use this to set parameters of COM4.

#### COM5 Configuration

Use this to set parameters of COM5.

#### COM6 Configuration

Use this to set parameters of COM6.

#### LPT1 Port Configuration

Use this set parameters of the onboard parallel port.

#### WDT Timeout Reset

This allows users to enable/disable the Watch Dog Timer timeout to reset system. The default value is [Disabled].

---

### 3.3.8 ACPI Configuration

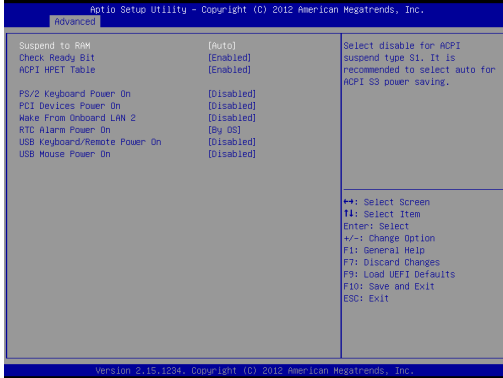

#### **Suspend to RAM**

Use this item to select whether to auto-detect or disable the Suspend-to-RAM feature. Select [Auto] will enable this feature if the OS supports it.

#### **Check Ready Bit**

Use this item to enable or disable the feature Check Ready Bit.

#### **ACPI HPET Table**

Use this item to enable or disable ACPI HPET Table. The default value is [Enabled]. Please set this option to [Enabled] if you plan to use this motherboard to submit Windows® certification.

#### **PS/2 Keyboard Power On**

Use this item to enable or disable PS/2 keyboard to turn on the system from the power-soft-off mode.

#### **PCI Devices Power On**

Use this item to enable or disable PCI devices to turn on the system from the power-soft-off mode.

#### **Wake From Onboard LAN 2**

Use this item to enable or disable the Wake From Onboard LAN 2 feature.

#### **RTC Alarm Power On**

Use this item to enable or disable RTC (Real Time Clock) to power on the system.

#### **USB Keyboard/Remote Power On**

Use this item to enable or disable USB Keyboard/Remote to power on the system.

#### **USB Mouse Power On**

Use this item to enable or disable USB Mouse to power on the system.

---

### 3.3.9 USB Configuration

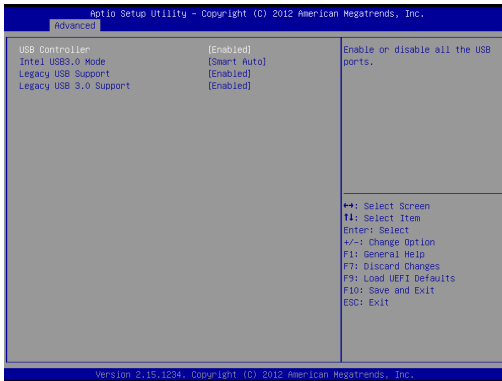

#### USB Controller

Use this item to enable or disable the use of USB controller.

#### Intel USB 3.0 Mode

Use this item to enable or disable the use of Intel USB 3.0 mode.

#### Legacy USB Support

Use this option to select legacy support for USB devices. There are four configuration options: [Enabled], [Auto], [Disabled] and [UEFI Setup Only]. The default value is [Enabled]. Please refer to below descriptions for the details of these four options:

[Enabled] - Enables support for legacy USB.

[Auto] - Enables legacy support if USB devices are connected.

[Disabled] - USB devices are not allowed to use under legacy OS and UEFI setup when [Disabled] is selected. If you have USB compatibility issues, it is recommended to select [Disabled] to enter OS.

[UEFI Setup Only] - USB devices are allowed to use only under UEFI setup and Windows / Linux OS.

#### Legacy USB 3.0 Support

Use this option to enable or disable legacy support for USB 3.0 devices. The default value is [Enabled].

---

### 3.3.10 Voltage Configuration

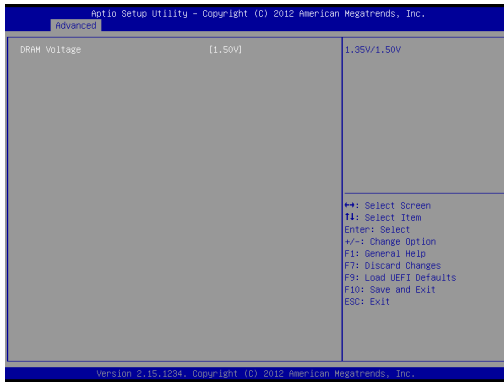

#### DRAM Voltage

Use this to select DRAM Voltage. The default value is [Auto].

---

### 3.4 Hardware Health Event Monitoring Screen

In this section, it allows you to monitor the status of the hardware on your system, including the parameters of the CPU temperature, motherboard temperature, CPU fan speed, chassis fan speed, and the critical voltage.

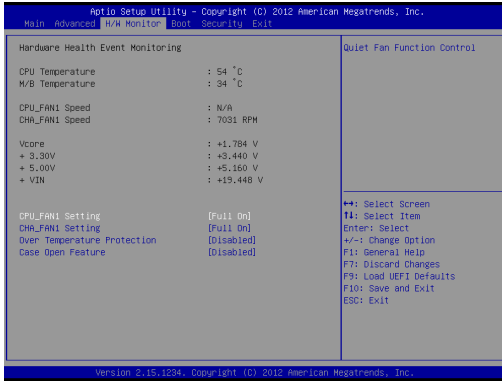

#### CPU\_FAN1 Setting

This allows you to set CPU fan 1's speed. Configuration options: [Full On] and [Automatic Mode]. The default value is [Full On].

#### CHA\_FAN1 Setting

This allows you to set chassis fan 1's speed. Configuration options: [Full On] and [Automatic Mode]. The default value is [Full On].

#### Over Temperature Protection

Use this to enable or disable Over Temperature Protection. The default value is [Enabled].

#### Case Open Feature

This allows you to enable or disable case open detection feature. The default is value [Disabled].

#### Clear Status

This option appears only when the case open has been detected. Use this option to keep or clear the record of previous chassis intrusion status.

---

## 3.5 Boot Screen

In this section, it will display the available devices on your system for you to configure the boot settings and the boot priority.



### Fast Boot

Fast Boot minimizes your computer's boot time. There are three configuration options: [Disabled], [Fast] and [Ultra Fast]. The default value is [Disabled]. Please refer to below descriptions for the details of these three options:

[Disabled] - Disable Fast Boot.

[Fast] - The only restriction is you may not boot by using an USB flash drive.

[Ultra Fast] - There are a few restrictions.

1. Only supports Windows® 8 UEFI operating system.
2. You will not be able to enter BIOS Setup (Clear CMOS or run utility in Windows® to enter BIOS Setup).
3. If you are using an external graphics card, the VBIOS must support UEFI GOP in order to boot.

### Boot From Onboard LAN

Use this item to enable or disable the Boot From Onboard LAN feature.

### Setup Prompt Timeout

This shows the number of seconds to wait for setup activation key. 65535(0XFFFF) means indefinite waiting.

### Bootup Num-Lock

If this item is set to [On], it will automatically activate the Numeric Lock function after boot-up.

---

## Boot Beep

Select whether the Boot Beep should be turned on or off when the system boots up. Please note that a buzzer is needed.

## Full Screen Logo

Use this item to enable or disable OEM Logo. The default value is [Enabled].

## AddOn ROM Display

Use this option to adjust AddOn ROM Display. If you enable the option “Full Screen Logo” but you want to see the AddOn ROM information when the system boots, please select [Enabled]. Configuration options: [Enabled] and [Disabled]. The default value is [Enabled].

## CSM

Please disable CSM when you enable Fast Boot option. The default value is [Enabled].

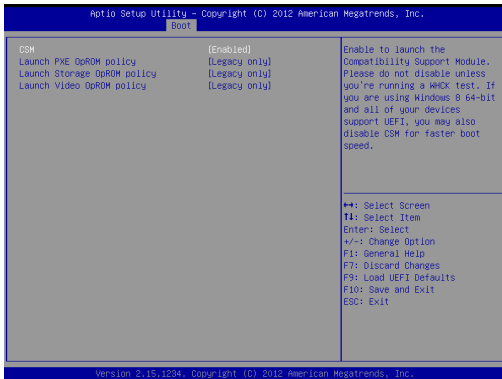



---

## 3.6 Security Screen

In this section, you may set, change or clear the supervisor/user password for the system.

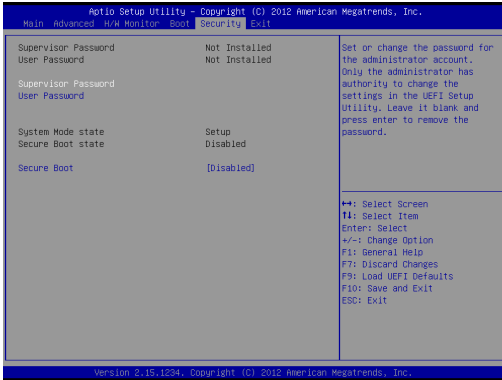

### Secure Boot

Use this to enable or disable Secure Boot. The default value is [Disabled].

---

## 3.7 Exit Screen

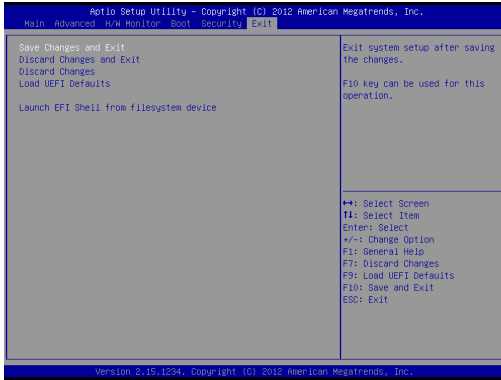

### Save Changes and Exit

When you select this option, it will pop-out the following message, "Save configuration changes and exit setup?" Select [OK] to save the changes and exit the UEFI SETUP UTILITY.

### Discard Changes and Exit

When you select this option, it will pop-out the following message, "Discard changes and exit setup?" Select [OK] to exit the UEFI SETUP UTILITY without saving any changes.

### Discard Changes

When you select this option, it will pop-out the following message, "Discard changes?" Select [OK] to discard all changes.

### Load UEFI Defaults

Load UEFI default values for all the setup questions. F9 key can be used for this operation.

### Launch EFI Shell from filesystem device

Attempts to Launch EFI Shell application (Shell64.efi) from one of the available filesystem devices.

---

# Chapter 4: Software Support

## 4.1 Install Operating System

This motherboard supports various Microsoft® Windows® operating systems: 8 / 8 64-bit / 7 / 7 64-bit. Because motherboard settings and hardware options vary, use the setup procedures in this chapter for general reference only. Refer your OS documentation for more information.

## 4.2 Support CD Information

The Support CD that came with the motherboard contains necessary drivers and useful utilities that enhance the motherboard's features.

### 4.2.1 Running The Support CD

To begin using the support CD, insert the CD into your CD-ROM drive. The CD automatically displays the Main Menu if "AUTORUN" is enabled in your computer. If the Main Menu did not appear automatically, locate and double click on the file "ASRSetup.exe" from the BIN folder in the Support CD to display the menus.

### 4.2.2 Drivers Menu

The Drivers Menu shows the available device's drivers if the system detects installed devices. Please install the necessary drivers to activate the devices.

### 4.2.3 Utilities Menu

The Utilities Menu shows the application software that the motherboard supports. Click on a specific item then follow the installation wizard to install it.

### 4.2.4 Contact Information

If you need to contact ASRock or want to know more about ASRock, you're welcome to visit ASRock's website at <http://www.asrock.com>; or you may contact your dealer for further information.