

SUPER  [®]

**X10SBA
X10SBA-L**

USER'S MANUAL

Revision 1.0b

The information in this user's manual has been carefully reviewed and is believed to be accurate. The vendor assumes no responsibility for any inaccuracies that may be contained in this document, makes no commitment to update or to keep current the information in this manual, or to notify any person or organization of the updates. **Please Note: For the most up-to-date version of this manual, please see our web site at www.supermicro.com.**

Super Micro Computer, Inc. ("Supermicro") reserves the right to make changes to the product described in this manual at any time and without notice. This product, including software and documentation, is the property of Supermicro and/or its licensors, and is supplied only under a license. Any use or reproduction of this product is not allowed, except as expressly permitted by the terms of said license.

IN NO EVENT WILL SUPERMICRO BE LIABLE FOR DIRECT, INDIRECT, SPECIAL, INCIDENTAL, SPECULATIVE OR CONSEQUENTIAL DAMAGES ARISING FROM THE USE OR INABILITY TO USE THIS PRODUCT OR DOCUMENTATION, EVEN IF ADVISED OF THE POSSIBILITY OF SUCH DAMAGES. IN PARTICULAR, SUPERMICRO SHALL NOT HAVE LIABILITY FOR ANY HARDWARE, SOFTWARE, OR DATA STORED OR USED WITH THE PRODUCT, INCLUDING THE COSTS OF REPAIRING, REPLACING, INTEGRATING, INSTALLING OR RECOVERING SUCH HARDWARE, SOFTWARE, OR DATA.

Any disputes arising between manufacturer and customer shall be governed by the laws of Santa Clara County in the State of California, USA. The State of California, County of Santa Clara shall be the exclusive venue for the resolution of any such disputes. Super Micro's total liability for all claims will not exceed the price paid for the hardware product.

FCC Statement: This equipment has been tested and found to comply with the limits for a class B digital device, pursuant to Part 15 of the FCC Rules. These limits are designed to provide reasonable protection against harmful interference in a residential installation. This equipment generates, uses, and can radiate radio frequency energy and, if not installed and used in accordance with the instructions, may cause harmful interference to radio communications. However, there is no guarantee that interference will not occur in a particular installation. If this equipment does cause harmful interference to radio or television reception, which can be determined by turning the equipment off and on, the user is encouraged to try to correct the interference by one or more of the following measures:

- Reorient or relocate the receiving antenna.
- Increase the separation between the equipment and receiver.
- Connect the equipment to an outlet on a circuit different from that to which the receiver is connected.
- Consult the authorized dealer or an experienced radio/TV technician for help.

California Best Management Practices Regulations for Perchlorate Materials: This Perchlorate warning applies only to products containing CR (Manganese Dioxide) Lithium coin cells. "Perchlorate Material-special handling may apply. See www.dtsc.ca.gov/hazardouswaste/perchlorate"

WARNING: Handling of lead solder materials used in this product may expose you to lead, a chemical known to the State of California to cause birth defects and other reproductive harm.

Manual Revision 1.0b

Release Date: August 29, 2014

Unless you request and receive written permission from Super Micro Computer, Inc., you may not copy any part of this document.

Information in this document is subject to change without notice. Other products and companies referred to herein are trademarks or registered trademarks of their respective companies or mark holders.

Copyright © 2014 by Super Micro Computer, Inc.

All rights reserved.

Printed in the United States of America

Preface

This manual is written for system integrators, PC technicians and knowledgeable PC users. It provides information for the installation and use of the **SUPER** X10SBA/X10SBA-L motherboard.

About This Motherboard

The **SUPER** X10SBA/X10SBA-L supports the next-generation Intel® Celeron J1900 SoC (System on a Chip) 22nm Quad-Core processor in the BGA 1170 format. With a 64-bit, 22nm, low-power Tri-gate Quad Core Silvermont processor built into it, the X10SBA(-L) motherboard offers unprecedented enhancements in system performance, power efficiency, and visual/media capability. This motherboard is ideal for SMB entry-level Storage, Server, or Appliance platforms that are optimized for networking, thin-client, Kiosk, Digital Signage, and control-box applications. Please refer to our website (<http://www.supermicro.com/products/>) for processor and memory support updates. This product is intended to be installed and serviced by professional technicians.

Manual Organization

Chapter 1 describes the features, specifications and performance of the motherboard, and provides detailed information on the Intel Celeron Bay Trail processor platform.

Chapter 2 provides hardware installation instructions. Read this chapter when installing the processor, memory modules and other hardware components into the system. If you encounter any problems, see **Chapter 3**, which describes troubleshooting procedures for video, memory and system setup stored in the CMOS.

Chapter 4 includes an introduction to the BIOS, and provides detailed information on running the CMOS Setup utility.

Appendix A provides BIOS Error Beep Codes.

Appendix B lists software program installation instructions.

Appendix C contains UEFI BIOS Recovery instructions.

Appendix D contains Dual Boot Block instructions.

Conventions Used in the Manual:

Special attention should be given to the following symbols for proper installation and to prevent damage done to the components or injury to yourself:

Warning: Critical information to prevent damage to the components or injury to yourself.



Important: Important information is given to ensure proper system installation or to relay safety precautions.



Note: Additional Information is provided for correct system setup.

1-4 Contacting Supermicro

Headquarters

Address: Super Micro Computer, Inc.
980 Rock Ave.
San Jose, CA 95131 U.S.A.

Tel: +1 (408) 503-8000

Fax: +1 (408) 503-8008

Email: marketing@supermicro.com (General Information)
support@supermicro.com (Technical Support)

Website: www.supermicro.com

Europe

Address: Super Micro Computer B.V.
Het Sterrenbeeld 28, 5215 ML
's-Hertogenbosch, The Netherlands

Tel: +31 (0) 73-6400390

Fax: +31 (0) 73-6416525

Email: sales@supermicro.nl (General Information)
support@supermicro.nl (Technical Support)
rma@supermicro.nl (Customer Support)

Website: www.supermicro.nl

Asia-Pacific

Address: Super Micro Computer, Inc.
3F, No. 150, Jian 1st Rd.
Zhonghe Dist., New Taipei City 235
Taiwan (R.O.C)

Tel: +886-(2) 8226-3990

Fax: +886-(2) 8226-3992

Email: support@supermicro.com.tw

Website: www.supermicro.com.tw

Table of Contents

Preface

Chapter 1 Introduction

1-1	Overview	1-1
	Checklist.....	1-1
	Motherboard Features.....	1-7
1-2	Processor Overview	1-11
1-3	Special Features	1-12
	Recovery from AC Power Loss.....	1-12
1-4	PC Health Monitoring.....	1-12
	Fan Status Monitor with Firmware Control	1-12
	Environmental Temperature Control	1-12
	System Resource Alert	1-12
1-5	ACPI Features.....	1-13
	Slow Blinking LED for Suspend-State Indicator	1-13
1-6	Power Supply	1-13
1-7	Super I/O.....	1-13

Chapter 2 Installation

2-1	Standardized Warning Statements	2-1
	Battery Handling.....	2-1
	Product Disposal	2-3
2-2	Static-Sensitive Devices.....	2-4
	Precautions	2-4
	Unpacking	2-4
2-3	Memory Support.....	2-5
	Memory Population Guidelines	2-5
	Populating Memory Modules.....	2-6
	Installing a SO-DIMM Module into a Horizontal Socket	2-7
	Removing a SO-DIMM Module from the Socket	2-7
2-4	Motherboard Installation.....	2-8
	Tools Needed	2-8
	Location of Mounting Holes	2-8
	Installing the Motherboard	2-9
2-5	Connectors/I/O Ports.....	2-10
	Backplane I/O Panel	2-10
	Universal Serial Bus (USB).....	2-11
	Ethernet Ports	2-12

	HDMI & DP Ports	2-12
	Video Connector	2-13
	Embedded DisplayPort (eDP)	2-14
	Front Control Panel	2-15
	Front Control Panel Pin Definitions	2-16
	Power LED	2-16
	HDD LED	2-16
	NIC1/NIC2 (LAN1/LAN2)	2-17
	Overheat (OH)/Fan Fail	2-17
	Reset Button	2-18
	Power Button	2-18
2-6	Connecting Cables	2-19
	ATX PWR & 12V DC PWR Connectors (JPW1 & PJ1)	2-19
	DOM PWR Connector (JSD1)	2-20
	Fan Headers (Fan 1/Fan 2)	2-20
	Internal Buzzer (SP1)	2-21
	Power LED/Speaker	2-21
	Serial Ports (COM1-COM4)	2-22
	Front Accessible Audio Header	2-22
	TPM Header/Port 80 Header	2-23
	SPDIF_OUT (JSPDIF_OUT)	2-23
	SMBUS1	2-24
	Overheat/Fan Fail LED	2-24
	GPIO Header (JP1)	2-25
2-7	Jumper Settings	2-26
	Explanation of Jumpers	2-26
	Audio Enable (JPAC1)	2-26
	CMOS Clear	2-27
	Manufacture Mode Select	2-27
	USB Wake-Up	2-28
2-8	Onboard Indicators	2-29
	LAN 1/LAN 2 LEDs	2-29
	Main Power LED	2-30
	Standby Power LED	2-30
2-9	SATA Connections	2-31
	SATA 2.0 & SATA 3.0 Connections	2-31
Chapter 3 Troubleshooting		
3-1	Troubleshooting Procedures	3-1

3-2	Technical Support Procedures	3-3
3-3	Frequently Asked Questions	3-4
3-4	Battery Removal and Installation	3-5
3-5	Returning Merchandise for Service.....	3-6

Chapter 4 BIOS

4-1	Introduction.....	4-1
4-2	Main Setup	4-2
4-3	Advanced Setup Configurations.....	4-4
4-4	Security Settings	4-22
4-5	Boot Settings.....	4-25
4-6	Save & Exit	4-27

Appendix A BIOS Error Beep Codes

A-1	BIOS Error Beep Codes	A-1
-----	-----------------------------	-----

Appendix B Software Installation Instructions

B-1	Installing Drivers.....	B-1
B-2	Configuring SuperDoctor [®] 5.....	B-2

Appendix C UEFI BIOS Recovery Instructions

C-1	An Overview to the UEFI BIOS	C-1
C-2	How to Recover the UEFI BIOS Image (-the Main BIOS Block).....	C-1
C-3	To Recover the Main BIOS Block Using a USB-Attached Device.....	C-1

Chapter 1

Introduction

1-1 Overview

Checklist

Congratulations on purchasing your computer motherboard from an acknowledged leader in the industry. Supermicro boards are designed with the utmost attention to detail to provide you with the highest standards in quality and performance.

Please check that the following items have all been included with your motherboard. If anything listed here is damaged or missing, contact your retailer.

The following items are included in the retail box.

- One (1) Supermicro Motherboard
- Six (6) SATA cables (for X10SBA)
- Two (2) SATA cables (for X10SBA-L)
- One (1) I/O shield
- One (1) Quick Reference Guide



Note: For your system to work properly, please follow the links below to download all necessary drivers/utilities and the user's manual for your motherboard.

SMCI product manuals: <http://www.supermicro.com/support/manuals/>

Product Drivers and utilities: <ftp://ftp.supermicro.com/>

If you have any questions, please contact our support team at support@supermicro.com.

SUPER[®] X10SBA Motherboard Image

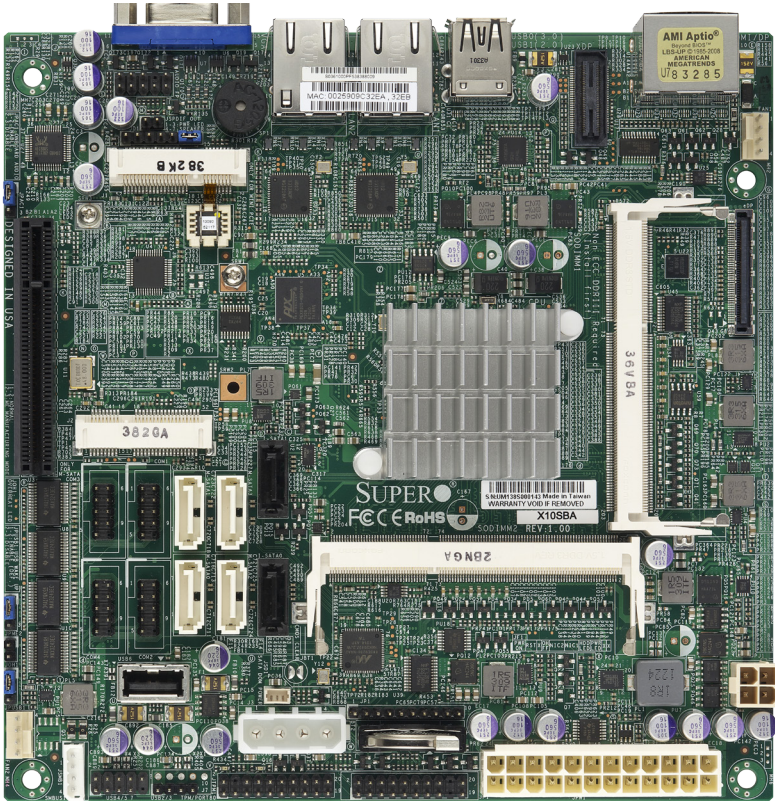

Notes:

1. All graphics shown in this manual were based upon the latest PCB Revision available at the time of publishing of the manual. The motherboard you've received may or may not look exactly the same as the graphics shown in this manual.
2. Some components are installed on the X10SBA only; some, on the X10SBA-L only. Refer to the table below for model variations between these two models.

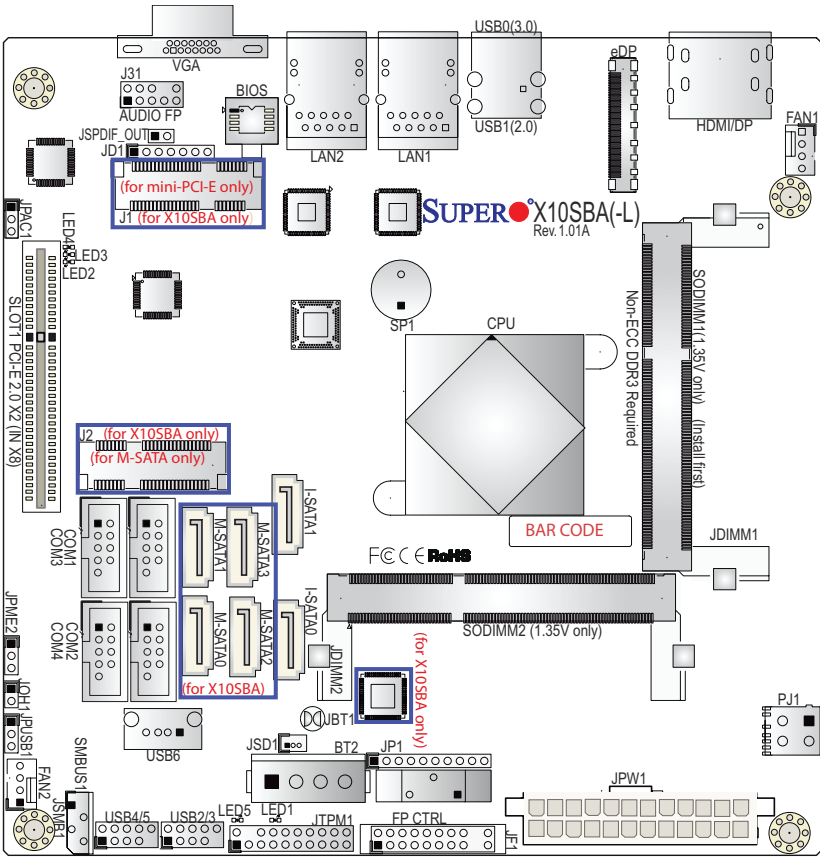

Differences between X10SBA and X10SBA-L		
	X10SBA	X10SBA-L
USB (2.0) Port 3	Not available	Yes
USB (2.0) Ports 4/5	Yes	Not available
Type A USB (2.0) USB 6	Yes	Not available
mini-PCI-E & SATA	Yes	Not available
4 SATA 3.0 from Marvell 88SE9230	Yes	Not available
eDP Support	Yes	Not available

X10SBA/X10SBA-L Quick Reference



Note: Some components are installed on the X10SBA only; some, on the X10SBA-L only. Refer to the table below for model variations between these two models.

X10SBA/X10SBA-L Jumpers		
Jumper	Description	Default
JBT1	CMOS Clear	Open: Normal (See Chpt. 2)
JPAC1	Audio Enable	Pins 1-2 (Enabled)
JPME2	Intel Manufacturer Mode Select	Pins 1-2 (Normal)
JPUSB1	USB Wake-Up Enable	Pins 1-2 (Enabled)



X10SBA/X10SBA-L Headers/Connectors	
Connector	Description
Audio FP	Front Panel Audio Header
Battery	Onboard Battery (BT2)
COM1-COM4	COM1/COM2/COM3/COM4 Headers
eDP	Embedded DisplayPort (J5) (Only available on the X10SBA)
Fan1/Fan2	System/CPU Fan Headers
HDMI/DP	(Backpanel) HDMI/DisplayPort
J1	mini-PCI-E Slot for a mini-PCI-E Card (Only available on the X10SBA)
J2	mSATA Slot MUX with I-SATA-1 (Only available on the X10SBA)  Note: mSATA MUX (J2) support is available only when I-SATA1 is not in use. J2 and I-SATA1 cannot be used together.
J4 (Slot 1)	PCI-E 2.0 x 2 in x8 Slot
JD1	Power LED/Speaker Header (Pins 1-3: Power LED, Pins 6-7: Internal Buzzer, Pins 4-7: External Speaker)
JF1	Front Panel Control Header
JOH1	Overheat LED Indicator Header
JP1	General Purpose I/O Header
JPW1	24-pin ATX Main Power Connector (Optional Power Source)
JSD1	SATA DOM (Device_On_Module) Power Connector
JSPDIF_OUT	S/PDIF (Sony/Phillips Digital Interconnect Format) Audio Output Header
JTPM1	Trusted Platform Module/Port 80 Connector
LAN1/LAN2	Gigabit Ethernet (RJ45) Ports (LAN1/2)
PJ1	4-pin 12V Power Connector (Optional Power Source)
(I-)SATA0/1	(Intel-)Serial ATA (SATA 2.0) Ports 0/1 (Optional Power Source)  Note: J2 and I-SATA1 cannot be used together.
(M-)SATA0-3	Marvell 88SE9230 Serial ATA (SATA 3.0) Ports 0-3 (Only available on the X10SBA)

SMBUS1 (JSMB1)	4-Pin External System Management Bus I ² C Header (JSMB1)
SP1	Internal Speaker/Buzzer
USB 0	Backpanel USB 3.0 Port 1
USB 1	Backpanel USB 2.0 Port 2
USB 2/3	Front Accessible USB 2.0 Connections: USB 2, USB 3 (USB 3: Only available on the X10SBA-L)
USB 4/5	Front Accessible USB 2.0 Connections: USB 4/5 (Only available on the X10SBA)
USB 6	Type A USB 2.0 Connector: USB 6 (Only available on the X10SBA)
VGA	Backpanel VGA Port

X10SBA/X10SBA-L LED Indicators

LED	Description	Color/State	Status
LED1	Main Power LED	Green: On	Power On
LED5	Standby Power LED	Green: On	AC On

Motherboard Features

CPU	Single Intel® J1900 SoC (System on a Chip) 64-bit, 22nm Low-Power, Quad-Core processor in the BGA 1170 format	
Memory	Supports up to 8 GB of 204-Pin Unbuffered DDR3L (Low Voltage), Non-ECC, SO-DIMM 1.35V modules of up to 1333 MHz in two horizontal sockets	
	 Note: This motherboard supports 1.35V memory only. Install the memory modules on the SO-DIMM1 socket first.	
	Dual-channel memory	
	DIMM Size: 2 GB, 4 GB	
Expansion Slots	One (1) PCI Express 2.0 x2 in x8 slot (Slot 1)	
	One (1) mini-PCI Express Slot (J1) (for mini-PCI-E only)	
	One (1) mSATA Slot MUX with a SATA 2.0 Port (J2)	
	 Note: mSATA MUX support is available only when I-SATA1 is not in use. J2 and I-SATA1 cannot be used together.	
Network Connections	Two (2) Intel i210AT Gigabit Ethernet Controllers	
	Two (2) RJ-45 rear I/O panel connectors with Link and Activity LEDs (LAN1/LAN2)	
I/O Devices	SATA Connections	
	SATA 2.0 (3 Gb/s)	Two (2) I-SATA 0/1 (Optional Power Source)
	SATA 3.0 (6 Gb/s)	Four (4) M-SATA 0-3 (not available on the -L model)
		RAID 0, 1, 10 (MS Windows®)
	USB Devices	
	One (1) USB 3.0 port on the rear I/O panel (USB 0)	
	One (1) USB 2.0 port on the rear I/O panel (USB 1)	
	Four (4) Front Accessible USB 2.0 ports on two headers (USB 2/3, 4/5), (USB 3: only available on the X10SBA-L, USB 4/5: Not available on the L model)	
	One (1) Type A USB 2.0 connector (USB 6: not available on the L model)	
	Serial (COM) Ports	
Four (4) front accessible Serial Port header (COM1-COM4)		
	One (1) mini-PCI-Express socket (J1)	
	One (1) mSATA socket (J2) (J2 is not available on the L-Model; J2 support is available only when I-SATA1 is not in use)	

	Video
	One (1) High Definition Multimedia Interface (HDMI) , One (1) DisplayPort, and One (1) VGA on the back panel One (1) eDP connector (not available on the L model)
	Audio
	One (1) HDMI and one (1) DisplayPort on the back panel One (1) Front panel dual-channel Audio Connector One (1) S/PDIF Digital Output Header
	Super I/O
	Nuvoton W83527HG
BIOS	64 Mb AMI BIOS® SPI Flash BIOS
	Plug and Play, ACPI 5.0, USB Keyboard, SMBIOS 2.7, UEFI 2.3.1, RTC (Real Time Clock) Wakeup, BIOS Hotkey Rescue,
Power Configuration	ACPI/ACPM, Power Management with S0, S3, S4, S5 support
	Main Switch Override Mechanism
	Keyboard Wake-up from Soft-Off
	External Modem Ring-On
	Power-on mode for AC power recovery
PC Health Monitoring	System Monitoring
	CPU/System overheat LED and control
	CPU Thermal Trip support
	Fan Control
	Fan status monitoring with firmware 4-pin fan speed control
	Low noise fan speed control
	System temperature monitor
System Management	System resource alert via SuperDoctor® 5
	SuperDoctor® 5, Watch Dog/NMI
	Power-On mode for AC power recovery
CD Utilities	BIOS flash upgrade utility
Other	ROHS (Full Compliance, Lead Free)
	Operating Temperature: 0-60C
Dimensions	Micro-ITX form factor (6.70" x 6.70") (170.18 mm x 170.18 mm)

Block Diagram

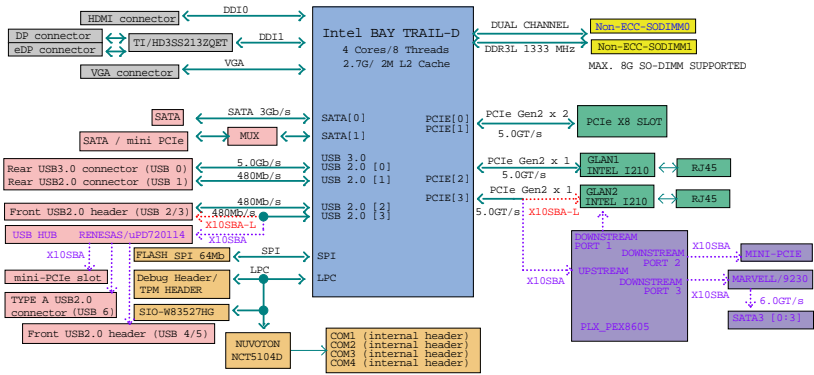

System Block Diagram

Note: This is a general block diagram and may not exactly represent the features on your motherboard. See the Motherboard Features pages for the actual specifications of each motherboard.

1-2 Processor Overview

The X10SBA/X10SBA-L motherboard supports the next-generation Intel® Celeron J1900 SoC (System on a Chip) 64-bit Quad-Core processor in the BGA 1170 format. Built upon the functionality and capability of the J1900 SoC processor in Low-Power 22nm Microarchitecture, the motherboard offers unprecedented enhancements in system performance, power efficiency, and visual/media capability for SMB entry-level storage, Digital Security, and Digital Signage platforms that are optimized for networking, thin-client, Kiosk, and control-box applications.

The J1900 SoC processor features an Out-of-Order Execution Engine and offers new multi-core and system fabric architecture capable of delivering four CPU cores to achieve higher single-thread performance. In addition, this new SoC processor also provides an operating range with wider dynamic power and enhanced power management with faster standby entry and standby support. The X10SBA/X10SBA-L offers two independent displays through HDMI, DP (eDP) or VGA outputs with full HD Video Decode/Encode capability.

Intel J1900 Series Processor Features

The J1900 Series processor offers the following features:

Performance

- Out-of Order Execution Pipeline
- Intel® Virtualization Technology (VT-x)
- Turbo Boost Technology
- DX*11, OpenGL 3.0, OpenCL 1.2, OppenGLES 2.0, and HD HQV support
- Intel Gen 7 Graphics and Media encode/decode engine, Full hardware acceleration decode and encode of H. 264, MPEG2, MVC
- Two independent displays with HDMI 1.4a, DP 1.1a
- Support of eDP 1.3 (Not available on the -L model)

Power Efficiency

- True Low Power SoC with single-packaging, single-die integrated functions
- Dynamic I/O power reduction
- ACPI 5.0 support

1-3 Special Features

Recovery from AC Power Loss

Basic I/O System (BIOS) provides a setting for you to determine how the system will respond when AC power is lost and then restored to the system. You can choose for the system to remain powered off, (in which case you must press the power switch to turn it back on), or for it to automatically return to a power-on state. See the Advanced BIOS Setup section to change this setting. The default setting is **Last State**.

1-4 PC Health Monitoring

This section describes the PC health monitoring features of the board. All have an onboard System Hardware Monitoring chip that supports PC health monitoring.

Fan Status Monitor with Firmware Control

PC health monitoring in the BIOS can check the RPM status of the cooling fans. The onboard CPU and chassis fans are controlled by Thermal Management.

Environmental Temperature Control

The thermal control sensor monitors CPU and system temperatures in real time, and will turn on the thermal control fan whenever the CPU or system temperature exceeds a user-defined threshold. The overheat circuitry runs independently from the CPU. Once the thermal sensor detects that the CPU or the system temperature is too high, it will automatically turn on the thermal fans to prevent the CPU or the system from overheating. The onboard chassis thermal circuitry can monitor the overall system temperature and alert the user when the chassis temperature is too high.



Note: To avoid possible system overheating, please be sure to provide adequate airflow to your system.

System Resource Alert

This feature is available when the system is used with SuperDoctor® 5 in the Windows OS environment or Linux. SuperDoctor is used to notify the user of certain system events. For example, you can also configure SuperDoctor 5 to provide you with warnings when the system temperature, CPU temperatures, voltages and fan speeds go beyond predefined thresholds.

1-5 ACPI Features

ACPI stands for Advanced Configuration and Power Interface. The ACPI specification defines a flexible and abstract hardware interface that provides a standard way to integrate power management features throughout a PC system, including its hardware, operating system and application software. This enables the system to automatically turn on and off peripherals such as CD-ROMs, network cards, hard disk drives and printers.

In addition to enabling operating system-directed power management, ACPI also provides a generic system event mechanism for Plug and Play, and an operating system-independent interface for configuration control. ACPI leverages the Plug and Play BIOS data structures, while providing a processor architecture-independent implementation that is compatible with Windows 64bit operating system.

Slow Blinking LED for Suspend-State Indicator

When the CPU goes into a suspend state, the chassis power LED will start to blink to indicate that the CPU is in suspend mode. When the user presses any key, the CPU will "wake up", and the LED will automatically stop blinking and remain on.

1-6 Power Supply

As with all computer products, a stable power source is necessary for proper and reliable operation. It is even more important for processors that have high CPU clock rates.

This motherboard accommodates 24-pin ATX power supplies. In addition to using the 24-pin power supply, the 12V 4-pin power connector located at PJ1 can also be used as another power source for space-restrained application.

It is strongly recommended that you use a high quality power supply that meets ATX power supply Specification 2.02 or above. It must also be SSI compliant. (For more information, please refer to the web site at <http://www.ssiforum.org/>). Additionally, in areas where noisy power transmission is present, you may choose to install a line filter to shield the computer from noise. It is recommended that you also install a power surge protector to help avoid problems caused by power surges.

1-7 Super I/O

The Super I/O supports four high-speed, 16550 compatible serial communication ports (UARTs). Each UART includes a 16-byte send/receive FIFO, a programmable baud rate generator, complete modem control capability and a processor interrupt system. Both UARTs provide legacy speed with baud rate of up to 115.2 Kbps

as well as an advanced speed with baud rates of 250 K, 500 K, or 1 Mb/s, which support higher speed modems.

The Super I/O provides functions that comply with ACPI (Advanced Configuration and Power Interface), which includes support of legacy and ACPI power management through an SMI or SCI function pin. It also features auto power management to reduce power consumption.

Notes

Chapter 2

Installation

2-1 Standardized Warning Statements

The following statements are industry-standard warnings, provided to warn the user of situations which have the potential for bodily injury. Should you have questions or experience difficulty, contact Supermicro's Technical Support department for assistance. Only certified technicians should attempt to install or configure components. Read this section in its entirety before installing or configuring components in the Supermicro chassis.

Battery Handling



Warning!

There is a danger of explosion if the battery is replaced incorrectly. Replace the battery only with the same or equivalent type recommended by the manufacturer. Dispose of used batteries according to the manufacturer's instructions

電池の取り扱い

電池交換が正しく行われなかった場合、破裂の危険性があります。交換する電池はメーカーが推奨する型、または同等のものを使用下さい。使用済電池は製造元の指示に従って処分して下さい。

警告

電池更換不當會有爆炸危險。請只使用同類電池或制造商推薦的功能相當的電池更換原有電池。請按製造商的說明處理廢舊電池。

警告

電池更換不當會有爆炸危險。請使用製造商建議之相同或功能相當的電池更換原有電池。請按照製造商的說明指示處理廢棄舊電池。

Warnung

Bei Einsetzen einer falschen Batterie besteht Explosionsgefahr. Ersetzen Sie die Batterie nur durch den gleichen oder vom Hersteller empfohlenen Batterietyp. Entsorgen Sie die benutzten Batterien nach den Anweisungen des Herstellers.

Attention

Danger d'explosion si la pile n'est pas remplacée correctement. Ne la remplacer que par une pile de type semblable ou équivalent, recommandée par le fabricant. Jeter les piles usagées conformément aux instructions du fabricant.

¡Advertencia!

Existe peligro de explosión si la batería se reemplaza de manera incorrecta. Reemplazar la batería exclusivamente con el mismo tipo o el equivalente recomendado por el fabricante. Desechar las baterías gastadas según las instrucciones del fabricante.

אזהרה!

קיימת סכנת פיצוץ של הסוללה במידה והוחלפה בדרך לא תקינה. יש להחליף את הסוללה בסוג התואם מחברת יצרן מומלצת.

סילוק הסוללות המשומשות יש לבצע לפי הוראות היצרן.

هناك خطر من انفجار في حالة استبدال البطارية بطريقة غير صحيحة فعليك استبدال البطارية فقط بنفس النوع أو ما يعادلها كما أوصت به الشركة المصنعة تخلص من البطاريات المستعملة وفقا لتعليمات الشركة الصانعة

경고!

배터리가 올바르게 교체되지 않으면 폭발의 위험이 있습니다. 기존 배터리와 동일하거나 제조사에서 권장하는 동등한 종류의 배터리로만 교체해야 합니다. 제조사의 안내에 따라 사용된 배터리를 처리하여 주십시오.

Waarschuwing

Er is ontploffingsgevaar indien de batterij verkeerd vervangen wordt. Vervang de batterij slechts met hetzelfde of een equivalent type die door de fabrikant aanbevolen wordt. Gebruikte batterijen dienen overeenkomstig fabrieksvoorschriften afgevoerd te worden.

Product Disposal



Warning!

Ultimate disposal of this product should be handled according to all national laws and regulations.

製品の廃棄

この製品を廃棄処分する場合、国の関係する全ての法律・条例に従い処理する必要があります。

警告

本产品的废弃处理应根据所有国家的法律和规章进行。

警告

本產品的廢棄處理應根據所有國家的法律和規章進行。

Warnung

Die Entsorgung dieses Produkts sollte gemäß allen Bestimmungen und Gesetzen des Landes erfolgen.

¡Advertencia!

Al deshacerse por completo de este producto debe seguir todas las leyes y reglamentos nacionales.

Attention

La mise au rebut ou le recyclage de ce produit sont généralement soumis à des lois et/ou directives de respect de l'environnement. Renseignez-vous auprès de l'organisme compétent.

סילוק המוצר

אזהרה!

סילוק סופי של מוצר זה חייב להיות בהתאם להנחיות וחוקי המדינה.

عند التخلص النهائي من هذا المنتج ينبغي التعامل معه وفقا لجميع القوانين واللوائح الوطنية

경고!

이 제품은 해당 국가의 관련 법규 및 규정에 따라 폐기되어야 합니다.

Waarschuwing

De uiteindelijke verwijdering van dit product dient te geschieden in overeenstemming met alle nationale wetten en reglementen.

2-2 Static-Sensitive Devices

Electrostatic-Discharge (ESD) can damage electronic components. To avoid damaging your system board, it is important to handle it very carefully. The following measures are generally sufficient to protect your equipment from ESD.

Precautions

- Use a grounded wrist strap designed to prevent static discharge.
- Touch a grounded metal object before removing the board from the antistatic bag.
- Handle the board by its edges only; do not touch its components, peripheral chips, memory modules or gold contacts.
- When handling chips or modules, avoid touching their pins.
- Put the motherboard and peripherals back into their antistatic bags when not in use.
- For grounding purposes, make sure your computer chassis provides excellent conductivity between the power supply, the case, the mounting fasteners and the motherboard.
- Use only the correct type of onboard CMOS battery. Do not install the onboard battery upside down to avoid possible explosion.

Unpacking

The motherboard is shipped in antistatic packaging to avoid static damage. When unpacking the board, make sure that the person handling it is static protected.

2-3 Memory Support

The X10SBA/X10SBA-L supports up to 8 GB of DDR3L (Low Voltage) Non-ECC SO-DIMM of up to 1333 MHz in two horizontal sockets. This motherboard supports 1.35V memory only. Populate memory on Socket SO-DIMM1 first.

 **Note:** Check the Supermicro website for recommended memory modules.

CAUTION

Exercise extreme care when installing or removing DIMM modules to prevent any possible damage.

Memory Population Guidelines

Please follow the table below when populating the motherboard.

Unbuffered DDR3L Non-ECC SO-DIMM Memory				
DIMM Slots per Channel	DIMMs Populated per Channel	DIMM Type	POR Speeds	Memory Population Sequence
2	1	Unbuffered DDR3L SO-DIMM	Up to 1333	JDIMM1, JDIMM2 (2 DIMMs)

 **Note:** Be sure to use memory modules of the same type, same speed, same frequency on the same motherboard. Mixing of memory modules of different types and speeds is not allowed.

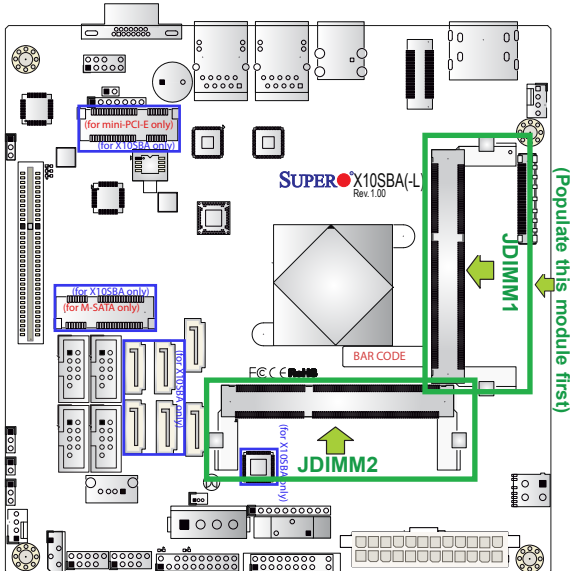

Populating Memory Modules

1. Install the desired number of SO-DIMMs into the memory slots, starting with JDIMM1, then JDIMM2. Pay attention to the notch along the bottom of the module to prevent incorrect DIMM module installation.
2. Insert each SO-DIMM module at the proper angle and snap it into place. Repeat step 1 to install JDIMM2. See the section below for more details on SO-DIMM memory installation.



Note: Due to memory allocation to system devices, the amount of memory that remains available for operational use will be reduced when 4 GB of RAM is used. The reduction in memory availability is disproportional. See the following table for details.

Possible System Memory Allocation & Availability		
System Device	Size	Physical Memory Remaining (-Available) (4 GB Total System Memory)
Firmware Hub flash memory (System BIOS)	1 MB	3.99
Local APIC	4 KB	3.99
Area Reserved for the chipset	2 MB	3.99
I/O APIC (4 Kbytes)	4 KB	3.99
PCI Enumeration Area 1	256 MB	3.76
PCI Express (256 MB)	256 MB	3.51
PCI Enumeration Area 2 (if needed) -Aligned on 256-MB boundary-	512 MB	3.01
VGA Memory	16 MB	2.85
TSEG	1 MB	2.84
Memory available to OS and other applications		2.84

Installing a SO-DIMM Module into a Horizontal Socket

1. Align the receptive point on the bottom of the SO-DIMM module against the key on the memory socket. Note the notches on the side of the SO-DIMM module and those on the socket to avoid causing damage.

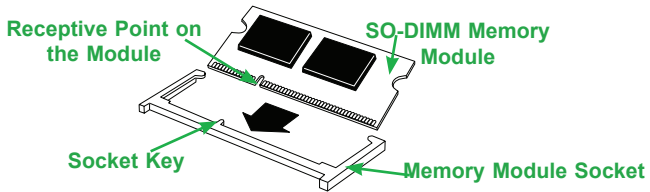

2. Line up the bottom of the SO-DIMM memory module with the edge of the horizontal socket.

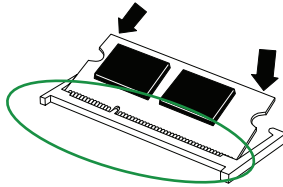

3. Once they are lined up, push the memory module into the memory socket until the module is securely seated in the socket.

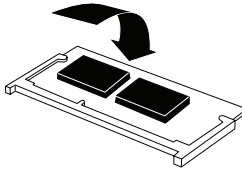

Removing a SO-DIMM Module from the Socket

1. Use your thumbs to gently push the side clips on both ends of the socket away from the SO-DIMM module to release it from the locked position.

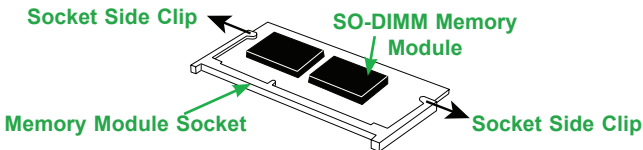

2. Once the memory module is loosened from the socket, pull it upwards and outwards to remove it from the socket.

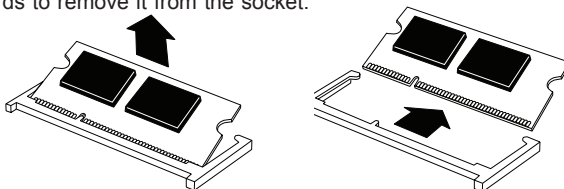

Installing the Motherboard

1. Install the I/O shield into the back of the chassis.

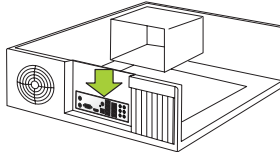

2. Locate the mounting holes on the motherboard. (See the previous page.)
3. Locate the matching mounting holes on the chassis. Align the mounting holes on the motherboard against the mounting holes on the chassis.
4. Install standoffs in the chassis as needed.

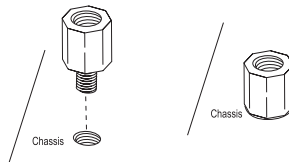

5. Install the motherboard into the chassis carefully to avoid damaging other motherboard components.
6. Using the Phillips screwdriver, insert a Phillips head #6 screw into a mounting hole on the motherboard and its matching mounting hole on the chassis.

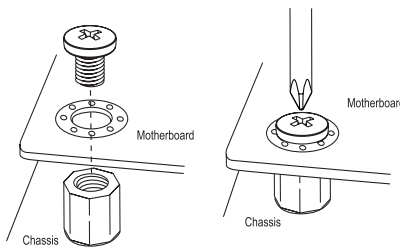

7. Repeat Step 5 to insert #6 screws into all mounting holes.
8. Make sure that the motherboard is securely placed in the chassis.

 **Note:** Images displayed are for illustration only. Your chassis or components might look different from those shown in this manual.

2-5 Connectors/I/O Ports

The I/O ports are color coded in conformance with the industry standards. See the figure below for the colors and locations of the various I/O ports.

Backplane I/O Panel

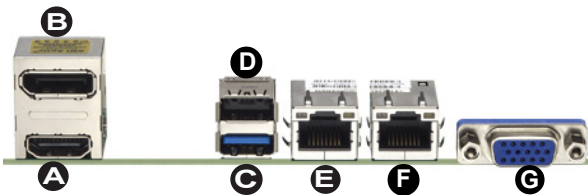
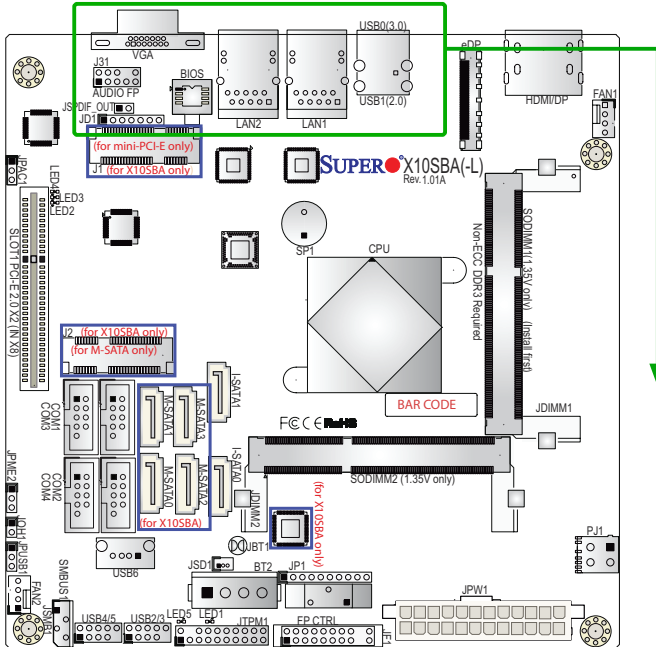

Backplane I/O Panel	
A. HDMI	E. LAN 1
B. DP	F. LAN 2
C. USB0 (3.0)	G. VGA
D. USB1 (2.0)	

Universal Serial Bus (USB)

One Universal Serial Bus 2.0 port (USB 0) and one USB 3.0 port (USB 1) are located on the I/O back panel. Three USB 2.0 connections (USB 2/3, USB 4/5) are located on the motherboard for front USB 2.0 access. In addition, a Type A USB connector (USB 6) is also located on the X10SBA to provide USB 2.0 front support. See the tables below for pin definitions.

Back Panel USB (2.0) #0, Type A USB 6 Pin Definitions			
Pin#	Definition	Pin#	Definition
1	+5V	5	+5V
2	USB_PN1	6	USB_PN0
3	USB_PP1	7	USB_PP0
4	Ground	8	Ground

Front Panel USB (2.0) USB 2/3, USB 4/5
Pin Definitions

Pin #	Definition	Pin #	Definition
	USB #2,4		USB #1,3
1	+5V	2	+5V
3	USB_PN2	4	USB_PN3
5	USB_PP2	6	USB_PP3
7	Ground	8	Ground
9	Key	10	Ground

Back Panel USB (3.0) USB 1 Pin Definitions			
Pin#	Pin#	Signal Name	Description
1	19	VBUS	Power
2	18	IntA_SSRX-	SuperSpeed Rx-
3	17	IntA_SSRX+	SuperSpeed Rx+
4	16	Ground	Ground
5	15	IntA_SSTX-	SuperSpeed Tx-
6	14	IntA_SSTX+	SuperSpeed Tx+
7	13	GND	Ground
8	12	IntA_D-	USB2 D-
9	11	IntA_D+	USB2 D+

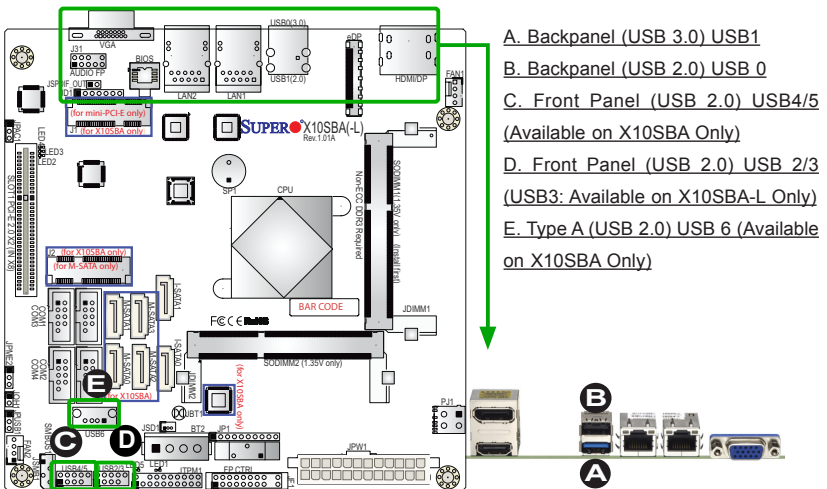

Ethernet Ports

Two Gigabit Ethernet ports (LAN1/ LAN2) are located on the I/O Backpanel to provide network connections. These ports accept RJ45 type cables.

 **Note:** Please refer to the LED Indicator Section for LAN LED information.

LAN Ports Pin Definition			
Pin#	Definition		
1	P2V5SB	10	SGND
2	TD0+	11	Act LED
3	TD0-	12	P3V3SB
4	TD1+	13	Link 100 LED (Green, +3V3SB)
5	TD1-	14	Link 1000 LED (Yellow, +3V3SB)
6	TD2+	15	Ground
7	TD2-	16	Ground
8	TD3+	17	Ground
9	TD3-	88	Ground

(NC: No Connection)

HDMI & DP Ports

One HDMI and one DisplayPort are located next to the VGA port on the I/O backpanel. These ports are used to display both high definition video and digital sound through an HDMI or DP-capable display, using a single HDMI or DP cable (not included). The X10SBA/L supports HDMI Specification version 1.4a and DP 1.1a.

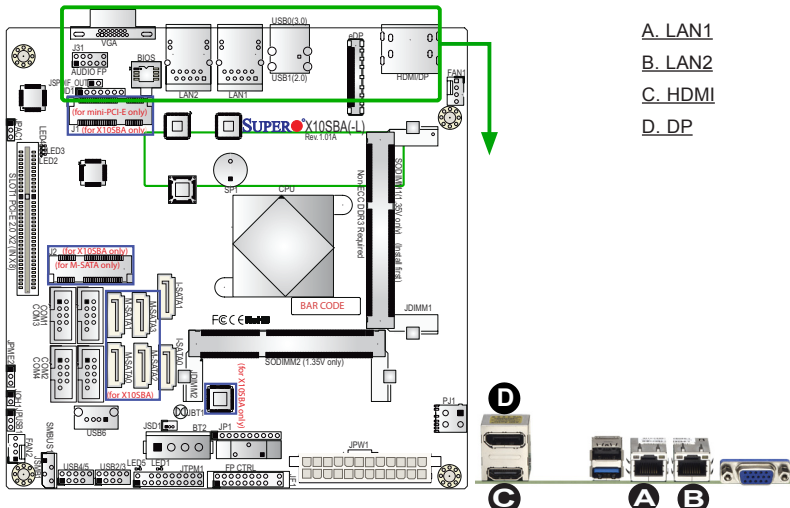

Video Connector

A Video (VGA) connector is located next to the LAN2 Port on the I/O backpanel. This connector is used to provide video display. Refer to the board layout below for the location.

VGA Pin Definitions			
Pin#	Definition	Pin#	Definition
1	Red	10	Ground
2	Green	11	MS0
3	Blue	12	MS1: SDA (DDC Data)
4	MS2	13	HSYNC
5	Ground	14	VSYSNC
6	Ground	15	MS3: SCL (DDC CLK)
7	Ground	16	Case
8	Ground	17	Case
9	NC		

NC= No Connection

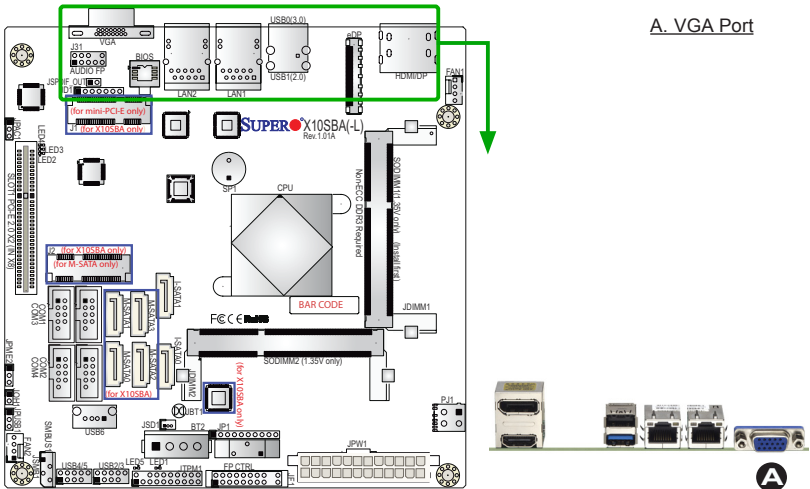

Embedded DisplayPort (eDP)

The eDP header is used to connect an embedded display LED or LCD Panel. eDP is a companion standard to the DisplayPort interface designed for embedded display applications, including notebook PCs, tablets, netbooks and all-in-one desktop PCs. Refer to the table on right for pin definitions. X10SBA support 3.3V eDP LED or LCD panel only. The X10SBA support eDP standard version 1.3. Refer to the table on the right for more information.

Note: eDP will be disabled by hardware when DP is connected with active display. Please make sure no display connected to back panel DP port when eDP function is required.

Embedded DisplayPort (eDP) Pin Definitions			
Pin#	Definition	Pin#	Definition
1	LCD_VCC	23	Lane0_N
2	LCD_VCC	24	Lane0_P
3	LCD_VCC	25	H_GND
4	LCD_VCC	26	AUX_CH_P
5	LCD_VCC	27	AUX_CH_N
6	LCD_GND	28	NC
7	LCD_GND	29	VCC3_3
8	LCD_GND	30	NC
9	LCD_GND	31	BL_PWR
10	HPF	32	NC
11	NC	33	GND
12	NC	34	VCC5
13	H_GND	35	L_CTRL_CLK
14	Lane3_N	36	L_BKLT_CTRL
15	Lane3_P	37	L_BKLT_EN
16	H_GND	38	BL_PWR
17	Lane2_N	39	VCC3_3
18	Lane2_P	40	H_GND
19	H_GND	41	SMB_CLK
20	Lane1_N	42	SMB_DATA
21	Lane1_P	43	NC
22	H_GND	44	NC

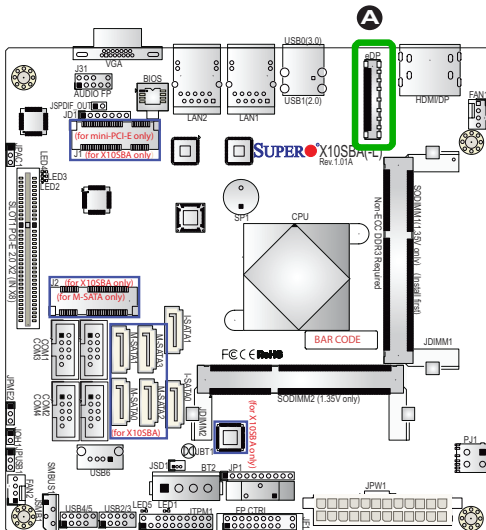

A. Embedded DisplayPort (eDP)

Front Control Panel

JF1 contains header pins for various buttons and indicators that are normally located on a control panel at the front of the chassis. These connectors are designed specifically for use with Supermicro chassis. See the figure below for the descriptions of the front control panel buttons and LED indicators. Refer to the following section for descriptions and pin definitions.

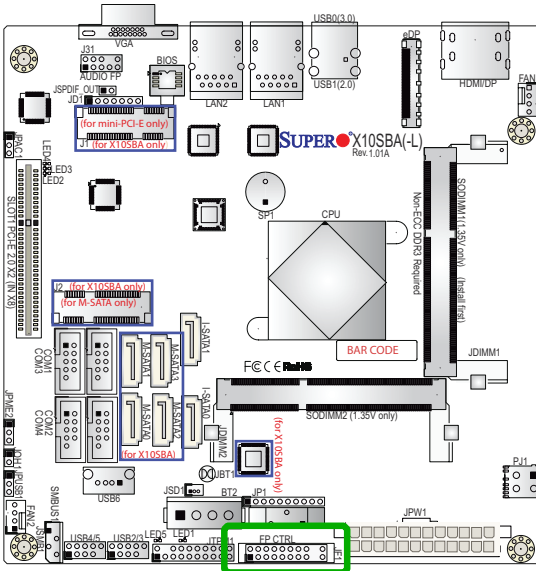

JF1 Header Pins

	20	19	
Ground	○	○	X
X	○	○	X
PWRLED	○	○	3.3 V
HDD LED	○	○	3.3V Stby
NIC1 Link LED	○	○	3.3V Stby
NIC2 Link LED	○	○	3.3V Stby
OH/Fan Fail/PWR Fail/ LED Cathode	○	○	
Power Fail LED	○	○	3.3V
Ground	○	○	Reset} Reset Button
Ground	○	○	PWR} Power Button
	2	1	

Front Control Panel Pin Definitions

Power LED

The Power LED connection is located on pins 15 and 16 of JF1. Refer to the table on the right for pin definitions.

Power LED Pin Definitions (JF1)	
Pin#	Definition
15	+5V
16	Ground

HDD LED

The HDD LED connection is located on pins 13 and 14 of JF1. Attach a cable here to indicate the status of HDD-related activities, including IDE, SATA activities. See the table on the right for pin definitions.

HDD LED Pin Definitions (JF1)	
Pin#	Definition
13	+5V
14	HD Active

A. PWR LED

B. HDD LED

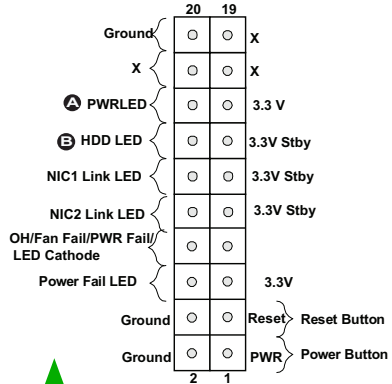
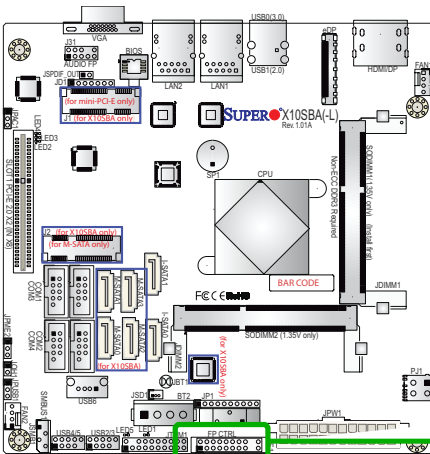

NIC1/NIC2 (LAN1/LAN2)

The NIC (Network Interface Controller) LED connection for LAN port 1 is located on pins 11 and 12 of JF1, and the LED connection for LAN Port 2 is on pins 9 and 10. Attach NIC LED cables to NIC1 and NIC2 LED indicators to display network activities. Refer to the table on the right for pin definitions.

LAN1/LAN2 LED Pin Definitions (JF1)	
Pin#	Definition
9/11	Vcc
10/12	Ground

Overheat (OH)/Fan Fail

Connect an LED cable to OH/Fan Fail connections on pins 7 and 8 of JF1 to provide warnings for overheat, fan failure or power failure. Refer to the table on the right for pin definitions.

OH/Fan Fail LED Pin Definitions (JF1)	
Pin#	Definition
7	Vcc/Blue UID LED
8	OH/Fan Fail LED

OH/Fan Fail Indicator Status	
State	Definition
Off	Normal
On	Overheat
Flashing	Fan Fail

- A. NIC1 LED
- B. NIC2 LED
- C. OH/Fan Fail/PWR Fail

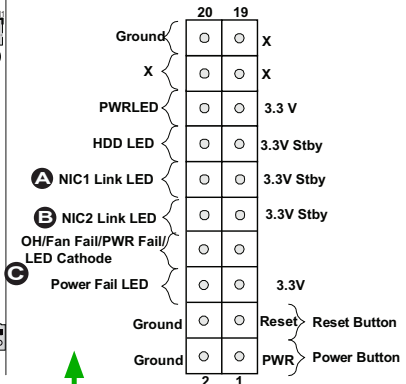
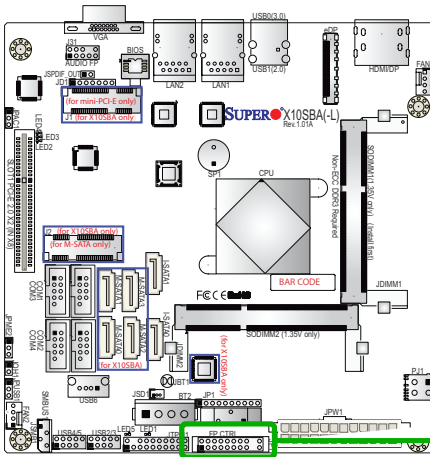

Reset Button

The Reset Button connection is located on pins 3 and 4 of JF1. Attach it to a hardware reset switch on the computer case to reset the system. Refer to the table on the right for pin definitions.

Reset Button Pin Definitions (JF1)	
Pin#	Definition
3	Reset
4	Ground

Power Button

The Power Button connection is located on pins 1 and 2 of JF1. Momentarily contacting both pins will power on/off the system. This button can also be configured to function as a suspend button (with a setting in the BIOS - see Chapter 4). To turn off the power in the suspend mode, press the button for at least 4 seconds. Refer to the table on the right for pin definitions.

Power Button Pin Definitions (JF1)	
Pin#	Definition
1	Signal
2	+3V Standby

A. Reset Button

B. PWR Button

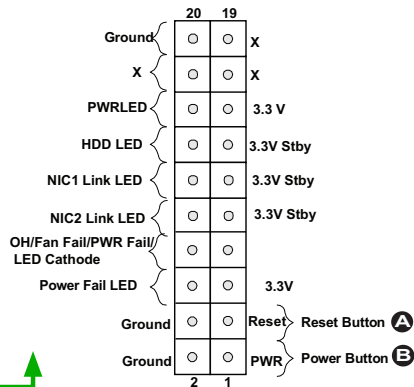
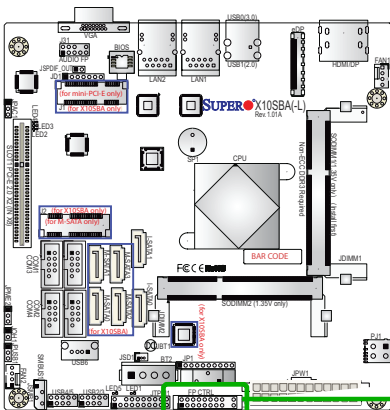

2-6 Connecting Cables

This section provides brief descriptions and pin-out definitions for onboard headers and connectors. Be sure to use the correct cable for each header or connector. For information on Backpanel USB and Front Panel USB ports, refer to page 2-11.

ATX PWR & 12V DC PWR Connectors (JPW1 & PJ1)

The 24-pin ATX power connector (JPW1) is used to provide power to the motherboard. The 4-pin 12V DC PWR connector (PJ1) can also be used as an optional power source when ATX power supply is not available. These power connectors meet the SSI EPS 12V specification. See the table on the right for pin definitions.

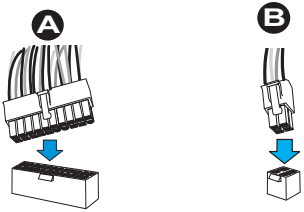

24-Pin Main PWR

12V DC PWR

Pin#	Definition	Pin #	Definition
13	+3.3V	1	+3.3V
14	-12V	2	+3.3V
15	COM	3	COM
16	PS_ON	4	+5V
17	COM	5	COM
18	COM	6	+5V
19	COM	7	COM
20	Res (NC)	8	PWR_OK
21	+5V	9	5VSB
22	+5V	10	+12V
23	+5V	11	+12V
24	COM	12	+3.3V

12V DC Power Connector Pin Definitions

Pins	Definition
1/2	Ground
3/4	+12V

(Optional)

A. 24-Pin ATX PWR

B. 12V DC PWR (up to 144W)

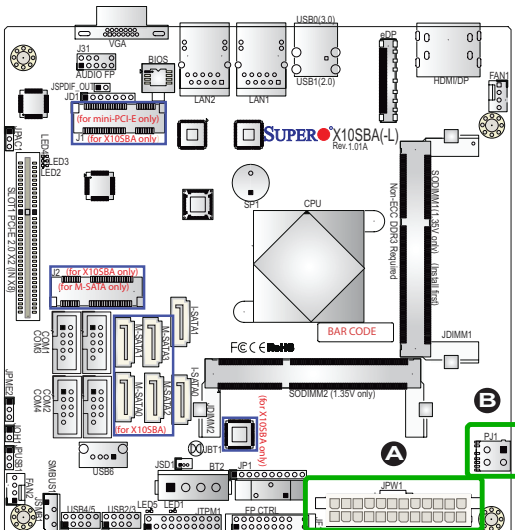

Internal Buzzer (SP1)

The Internal Buzzer (SP1) can be used to provide audible indications for various beep codes. See the tables on the right for pin definitions.

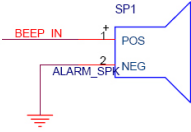

Internal Buzzer Pin Definition		
Pin#	Definitions	
Pin 1	Pos. (+)	Beeper In
Pin 2	Neg. (-)	Alarm Speaker

Speaker Connector Pin Definitions	
Pin Setting	Definition
Pins 3-4	Internal Speaker
Pins 1-4	External Speaker

Power LED/Speaker

Pins 1-3 of JD1 are used for power LED indication, and pins 4-7 are for the speaker. See the tables on the right for pin definitions. Please note that the speaker connector pins (4-7) are used with an external speaker. If you wish to use the onboard speaker, you should close pins 6-7 with a cap.

PWR LED Connector Pin Definitions	
Pin Setting	Definition
Pin 1	Anode (+)
Pin2	Cathode (-)
Pin3	NA

Speaker Connector Pin Settings	
Pin Setting	Definition
Pins 4-7	External Speaker
Pins 6-7	Internal Speaker

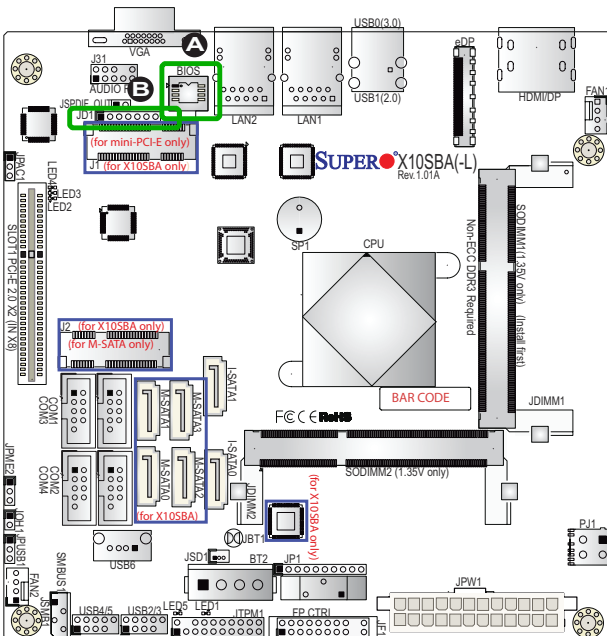

- A. Internal Buzzer
- B. PWR LED/Speaker Header

Serial Ports (COM1-COM4)

There are two serial (COM) port headers on the motherboard. Refer to the layout below for COM port locations. See the table on the right for pin definitions.

Serial/COM Ports Pin Definitions			
Pin #	Definition	Pin #	Definition
1	DCD	6	DSR
2	RXD	7	RTS
3	TXD	8	CTS
4	DTR	9	RI
5	Ground	10	N/A

Front Accessible Audio Header

A 10-pin Audio header is located at J31 on the motherboard. This header allows you to use the onboard sound for audio playback. Connect an audio cable to the audio header to use this feature. See the table on the right for pin definitions for the header.

10-in Audio Pin Definitions	
Pin#	Signal
1	Microphone_Left
2	Audio_Ground
3	Microphone_Right
4	Audio_Detect
5	Line_2_Right
6	Ground
7	Jack_Detect
8	Key
9	Line_2_Left
10	Ground

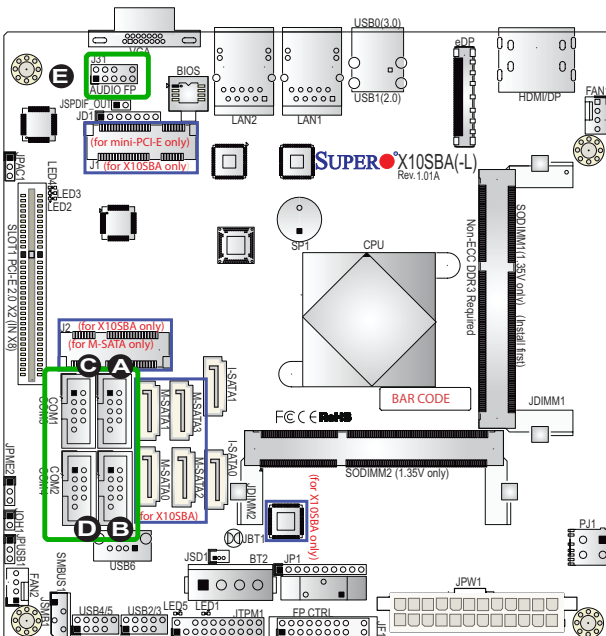

- A. COM1
- B. COM2
- C. COM3
- D. COM4
- E. Front Audio

TPM Header/Port 80 Header

A Trusted Platform Module/Port 80 header is located at JTPM1 to provide TPM support and Port 80 connection. Use this header to enhance system performance and data security. See the table on the right for pin definitions.

TPM/Port 80 Header Pin Definitions			
Pin #	Definition	Pin #	Definition
1	LCLK	2	GND
3	LFRAME#	4	<(KEY)>
5	LRESET#	6	+5V (X)
7	LAD 3	8	LAD 2
9	+3.3V	10	LAD1
11	LAD0	12	GND
13	SMB_CLK4	14	SMB_DAT4
15	+3V_DUAL	16	SERIRQ
17	GND	18	CLKRUN# (X)
19	LPCPD#	20	LDRQ# (X)

SPDIF_OUT (JSPDIF_OUT)

The SP/DIF Out (JSPDIF_OUT) is used for digital audio. You will also need the appropriate cable to use these features.

SPDIF_Out Pin Definitions	
Pin#	Definition
1	S/PDIF_Out
2	Ground

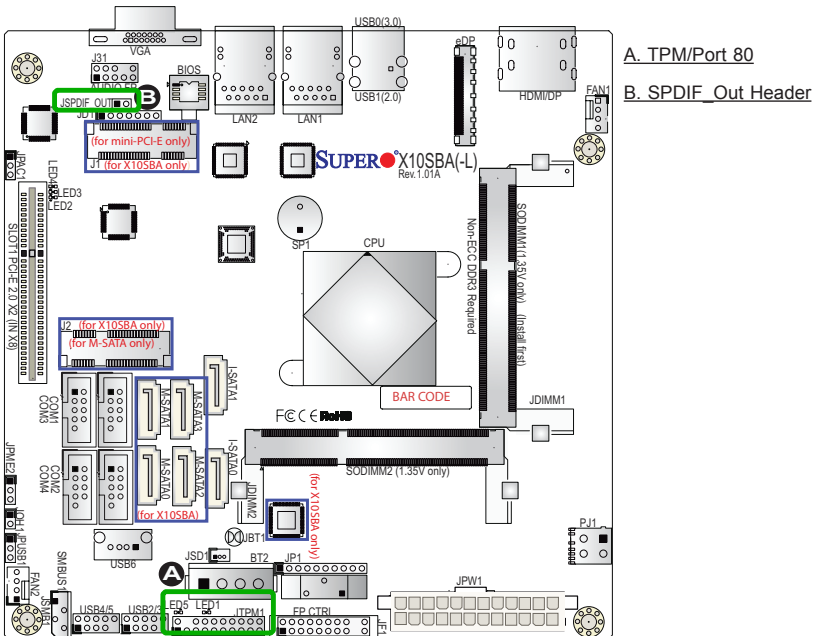

SMBUS1

A System Management Bus header for the SMBus slave sensor is located at JSMB1. Connect the appropriate cable here to use the SMBus I²C connection on your system.

SMBUS1 Header Pin Definitions	
Pin#	Definition
1	Data
2	Ground
3	Clock
4	No Connection

Overheat/Fan Fail LED

The JOH1 header is used to connect an LED indicator to provide warnings of chassis overheating and fan failure. This LED will blink when a fan failure occurs. Refer to the table on right for pin definitions.

OH/Fan Fail LED Status	
State	Message
Solid	Overheat
Blinking	Fan Fail

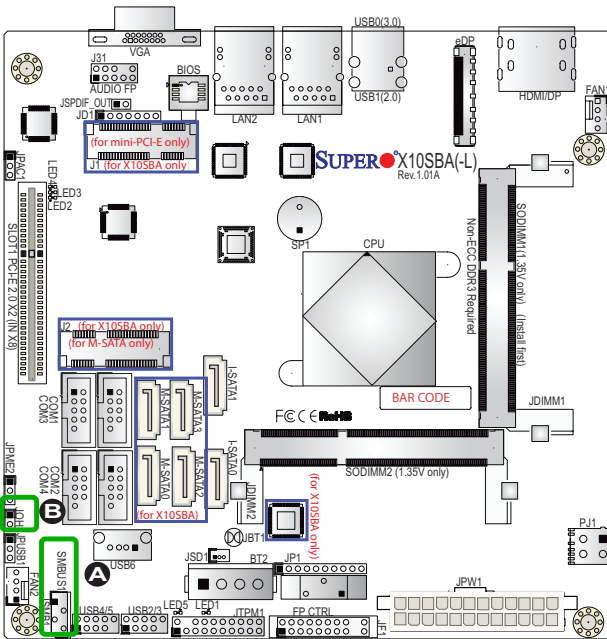

- A. JSMB1
- B. Overheat/Fan Fail LED

GPIO Header (JP1)

The JP1 header is located near the onboard battery on the motherboard. JP1 is a 10-pin general purpose I/O header. Each pin can be configured to be an input pin or open drain output pin. See the table on the right for pin definitions.

General Purpose I/O Header Pin Definitions	
Pin#	Definition
1	+3.3V
2	SOC_P3V3_GPIO_S5_31
3	SOC_P3V3_GPIO_S5_32
4	SOC_P3V3_GPIO_S5_33
5	SOC_P3V3_GPIO_S5_34
6	SOC_P3V3_GPIO_S5_35
7	SOC_P3V3_GPIO_S5_36
8	SOC_P3V3_GPIO_S5_37
9	SOC_P3V3_GPIO_S5_38
10	GND

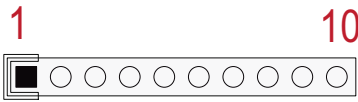

JP1 Pin Layout

A. General Purpose Header

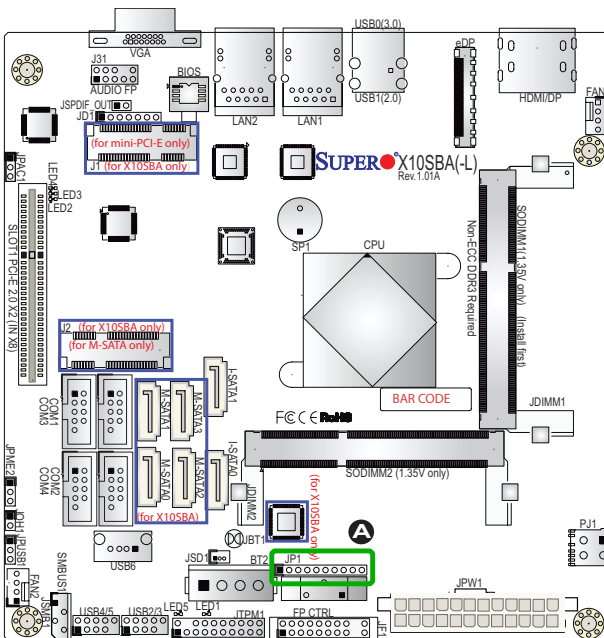

2-7 Jumper Settings

Explanation of Jumpers

To modify the operation of the motherboard, jumpers can be used to choose between optional settings. Jumpers create shorts between two pins to change the function of the connector. Pin 1 is identified with a square solder pad on the printed circuit board.

Note: On two-pin jumpers, "Closed" means the jumper is on, and "Open" means the jumper is off the pins.

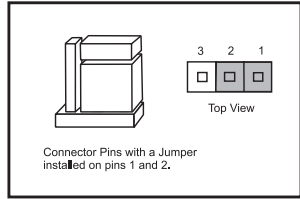
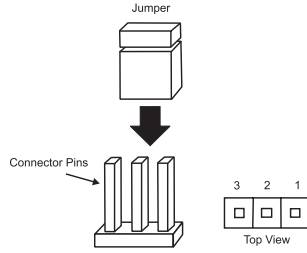

Audio Enable (JPAC1)

JPAC1 allows you to enable or disable the onboard audio support. The default position is on pins 1 and 2 to enable onboard audio connections. See the table on the right for jumper settings.

Audio Enable/Disable Jumper Settings

Both Jumpers	Definition
Pins 1-2	Enabled
Pins 2-3	Disabled

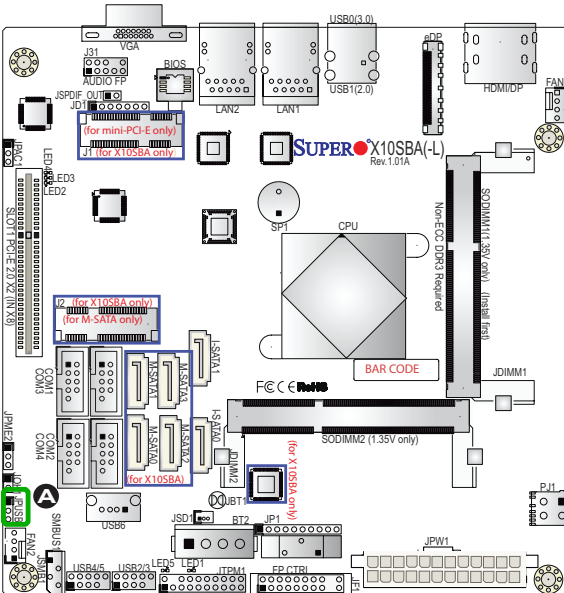

A. Audio Enable

CMOS Clear

JBT1 is used to clear CMOS. Instead of pins, this "jumper" consists of contact pads to prevent accidental clearing of CMOS. To clear CMOS, use a metal object such as a small screwdriver to touch both pads at the same time to short the connection. Always remove the AC power cord from the system before clearing CMOS.

Note 1: For an ATX power supply, you must completely shut down the system, remove the AC power cord, and then short JBT1 to clear CMOS.

Note 2: Be sure to remove the onboard CMOS Battery before you short JBT1 to clear CMOS.

Note 3: Clearing CMOS will also clear all passwords.

Manufacture Mode Select

Close pins 2 and 3 of Jumper JPME2 to bypass SPI flash security and force the system to operate in the Manufacture Mode, allowing the user to flash the system firmware from a host server for system setting modifications. See the table on the right for jumper settings.

Manufacture Mode Select Jumper Settings	
Jumper Setting	Definition
1-2	Normal (Default)
2-3	Manufacture Mode

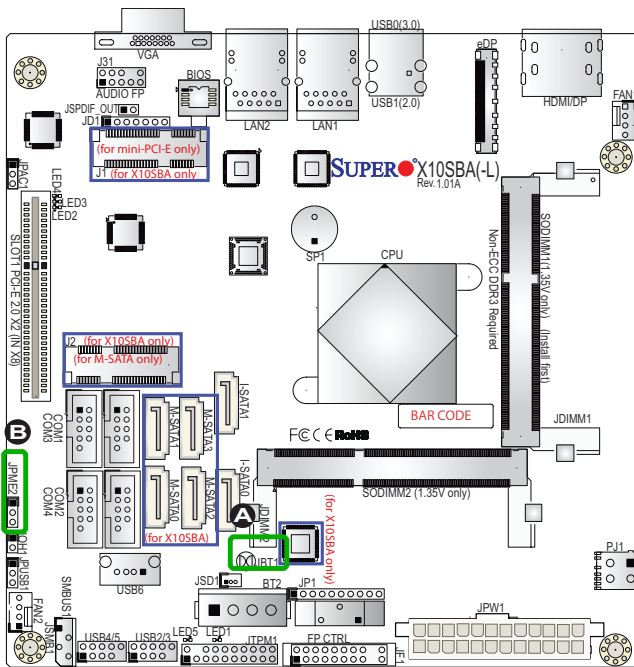

- A. Clear CMOS
- B. Manufacturer Mode Select

USB Wake-Up

Use the jumper JPUSB1 to "wake-up" your system by pressing a key on a USB keyboard or clicking the USB mouse connected to the onboard USB ports. JPUSB1 is used together with a USB Wake-Up feature in the BIOS. Enable this jumper and the "USB Wake-Up" support in the BIOS to wake up your system via USB devices.

USB Wake-Up Enable Jumper Settings	
Pin#	Definition
1-2	Enabled (Default)
2-3	Disabled

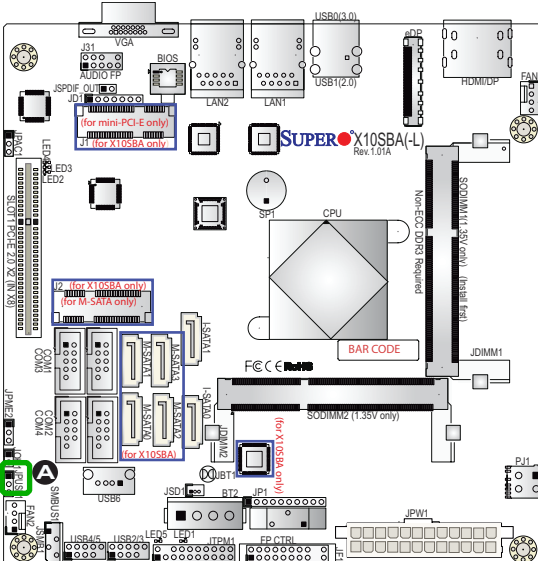

A. USB Wake-Up Enable

2-8 Onboard Indicators

LAN 1/LAN 2 LEDs

Two LAN ports (LAN 1/LAN 2) are located on the I/O backplane of the motherboard. Each Ethernet LAN port has two LEDs. The yellow LED indicates activity, while the Link LED may be green, amber, or off to indicate the speed of the connections. See the tables at right for more information.

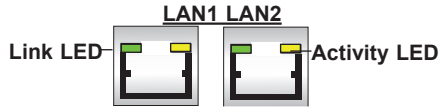

GLAN 1/2 Activity Indicator LED Settings		
Color	Status	Definition
Yellow	Flashing	Active

GLAN Ports 1/2 Link Indicator LED Settings	
LED Color	Definition
Off	No Connection/10 Mbps
Amber	1 Gbps
Green	100 Mbps

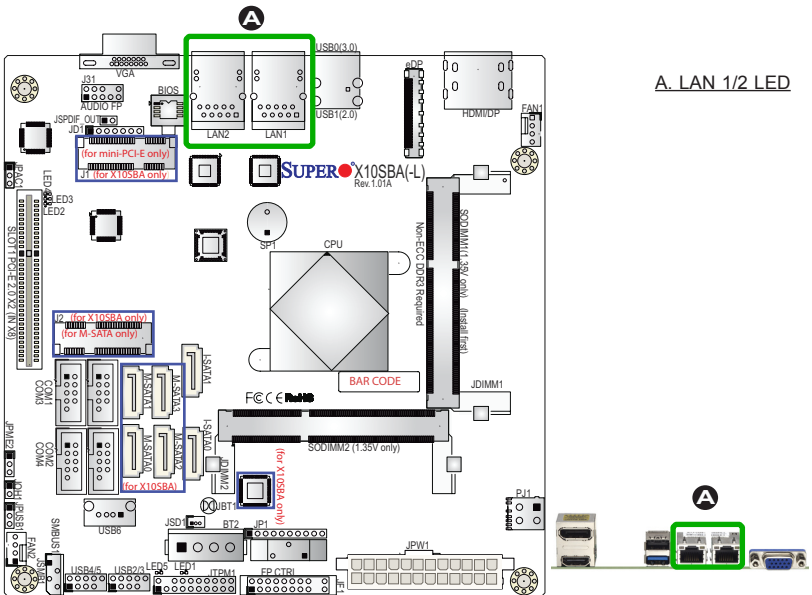

Main Power LED

A Main Power LED is located at LED1 on the motherboard. When this LED is on, the system power is on. Be sure to turn off the system power and unplug the power cord before removing or installing components. See the table on the right for more information.

Main PWR LED Indicator LED Settings	
LED Color	Definition
Off	System Off (PWR cable not connected)
Green	System Power On
Green: Flashing Quickly	ACPI S1 State

Standby Power LED

The 5V Standby Power LED is located at LED5 on the motherboard. When this LED is on, the standby power is connected. Be sure to unplug the power cable before removing or installing components. See the table in the right for more information.

Standby PWR LED Indicator LED Settings	
LED Color	Definition
Off	5V Standby Power Off (PWR cable not connected)
Green	Standby PWR Cable Connected

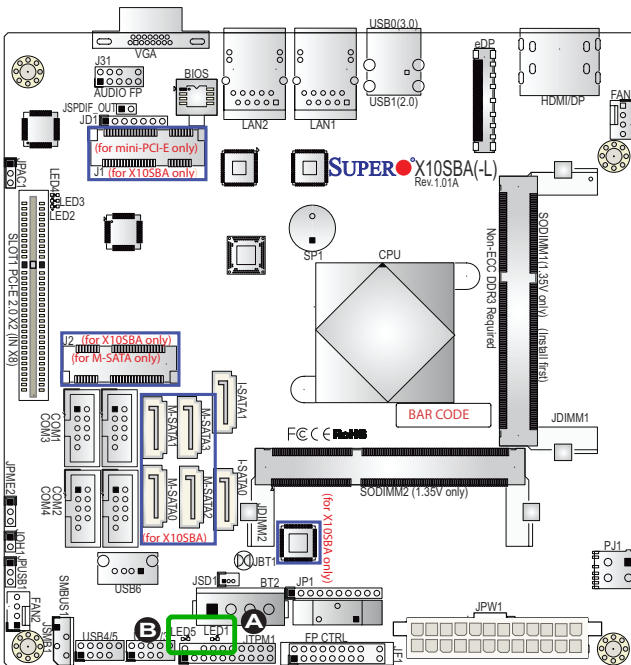

- A. Main PWR LED
- B. Standby PWR LED

Notes

Chapter 3

Troubleshooting

3-1 Troubleshooting Procedures

Use the following procedures to troubleshoot your system. If you have followed all of the procedures below and still need assistance, refer to the 'Technical Support Procedures' and/or 'Returning Merchandise for Service' section(s) in this chapter. Always disconnect the AC power cord before adding, changing or installing any hardware components.

Before Power On

1. Make sure that the Standby PWR LED is not on. (**Note:** If it is on, the onboard power is on. Be sure to unplug the power cable before installing or removing the components.)
2. Make sure that there are no short circuits between the motherboard and chassis.
3. Disconnect all ribbon/wire cables from the motherboard, including those for the keyboard and mouse. Also, be sure to remove all add-on cards.
4. Properly install a heatsink as needed, and then connect the chassis speaker and the power LED to the motherboard. Check all jumper settings as well.

No Power

1. Make sure that there are no short circuits between the motherboard and chassis.
2. Make sure that all jumpers are set to their default positions.
3. Check if the 115V/230V switch on the power supply is properly set.
4. Turn the power switch on and off to test the system.
5. The battery on your motherboard may be old. Check to make sure that it still supplies ~3VDC. If it does not, replace it with a new one.

No Video

1. If the power is on, but you have no video--in this case, you will need to remove all the add-on cards and cables first.
2. Use the speaker to determine if any beep codes exist. (Refer to Appendix A for details on beep codes.)
3. Remove all memory modules and turn on the system. (If the alarm is on, check the specifications of memory modules, reset the memory or try a different one.)

Memory Errors

1. Make sure that the DIMM modules are properly installed and fully seated in the slots.
2. You should be using SO-DIMM Non-ECC DDR3L (Low Voltage) memory of up to 1333 MHz memory recommended by the manufacturer. Also, it is recommended that you use the memory modules of the same type and speed for all DIMMs in the system. Do not use memory modules of different sizes, different speeds and different types on the same motherboard.
3. Check for bad DIMM modules or slots by swapping modules between slots to see if you can locate the faulty ones.
4. Check the switch of 115V/230V power supply.

Losing the System's Setup Configuration

1. Please be sure to use a high quality power supply. A poor quality power supply may cause the system to lose CMOS setup information. Refer to Section 1-5 for details on recommended power supplies.
2. The battery on your motherboard may be old. Check to verify that it still supplies ~3VDC. If it does not, replace it with a new one.
3. If the above steps do not fix the Setup Configuration problem, contact your vendor for repairs.

3-2 Technical Support Procedures

Before contacting Technical Support, please make sure that you have followed all the steps listed below. Also, Note that as a motherboard manufacturer, Supermicro does not sell directly to end users, so it is best to first check with your distributor or reseller for troubleshooting services. They should know of any possible problem(s) with the specific system configuration that was sold to you.

1. Please go through the 'Troubleshooting Procedures' and 'Frequently Asked Question' (FAQ) sections in this chapter or see the FAQs on our website (<http://www.supermicro.com/support/faqs/>) before contacting Technical Support.
2. BIOS upgrades can be downloaded from our website at (<http://www.supermicro.com/support/bios/>).



Note: Not all BIOS can be flashed. Some cannot be flashed; it depends on the boot block code of the BIOS.

3. If you've followed the instructions above to troubleshoot your system, and still cannot resolve the problem, then contact Supermicro's technical support and provide them with the following information:
 - Motherboard model and PCB revision number
 - BIOS release date/version (this can be seen on the initial display when your system first boots up)
 - System configuration
 - An example of a Technical Support form is on our website at (<http://www.supermicro.com/support/rma/rma.cfm>).
4. Distributors: For immediate assistance, please have your account number ready when placing a call to our technical support department. We can be reached by e-mail at support@supermicro.com, by phone at: (408) 503-8000, option 2, or by fax at (408)503-8019.

3-3 Frequently Asked Questions

Question: What type of memory does my motherboard support?

Answer: The X10SBA/X10SBA-L supports unbuffered Non-ECC DDR3L Low Voltage SO-DIMM (1.35V, of up to 1333 MHz). See Section 2-4 for details on installing memory.

Question: How do I update my BIOS?

Answer: We do NOT recommend that you upgrade your BIOS if you are not experiencing any problems with your system. Updated BIOS files are located on our website at <http://www.supermicro.com/support/bios/>. Please check our BIOS warning message and the information on how to update your BIOS on our web site. Select your motherboard model and download the BIOS ROM file to your computer. Also, check the current BIOS revision to make sure that it is newer than your BIOS before downloading. You may choose the zip file or the .exe file. If you choose the zipped BIOS file, please unzip the BIOS file onto a bootable device or a USB pen/thumb drive. To flash the BIOS, run the batch file named "ami.bat" with the new BIOS ROM file from your bootable device or USB pen/thumb drive. Use the following format:

```
F:\> ami.bat BIOS-ROM-filename.xxx <Enter>
```



Note: Always use the file named "ami.bat" to update the BIOS, and insert a space between "ami.bat" and the filename. The BIOS-ROM-filename will bear the motherboard name (i.e., X10SBA/X10SBA-L) and build version as the extension. For example, "X10SBA.115". When completed, your system will automatically reboot.

If you choose the .exe file, please run the .exe file under Windows to create the BIOS flash floppy disk. Insert the floppy disk into the system you wish to flash the BIOS. Then, boot the system to the floppy disk. The BIOS utility will automatically flash the BIOS without any prompts. Please note that this process may take a few minutes to complete. Do not be concerned if the screen is paused for a few minutes.

When the BIOS flashing screen is completed, the system will reboot and will show "Press F1 or F2". At this point, you will need to load the BIOS defaults. Press <F1> to go to the BIOS setup screen, and press <F9> to load the default settings. Next, press <F10> to save and exit. The system will then reboot.

Warning: Do not shut down or reset the system while updating the BIOS to prevent possible system boot failure!



Important: The SPI BIOS chip installed on this motherboard is not removable. To repair or replace a damaged BIOS chip, please send your motherboard to RMA at Supermicro for service.

Question: I think my BIOS is corrupted. How can I recover my BIOS?

Answer: Please see Appendix C-BIOS Recovery for detailed instructions.

3-4 Battery Removal and Installation

Battery Removal

To remove the onboard battery, follow the steps below:

1. Power off your system and unplug your power cable.
2. Locate the onboard battery as shown below.
3. Using a tool such as a pen or a small screwdriver, push the battery lock outwards to unlock it. Once unlocked, the battery will pop out from the holder.
4. Remove the battery.

Proper Battery Disposal

Warning: Please handle used batteries carefully. Do not damage the battery in any way; a damaged battery may release hazardous materials into the environment. Do not discard a used battery in the garbage or a public landfill. Please comply with the regulations set up by your local hazardous waste management agency to dispose of your used battery properly.

Battery Installation

1. To install an onboard battery, follow the steps 1 & 2 above and continue below:
2. Identify the battery's polarity. The positive (+) side should be facing up.
3. Insert the battery into the battery holder and push it down until you hear a click to ensure that the battery is securely locked.

Warning: When replacing a battery, be sure to only replace it with the same type.

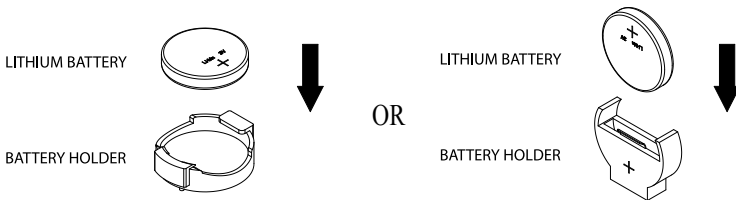

3-5 Returning Merchandise for Service

A receipt or copy of your invoice marked with the date of purchase is required before any warranty service will be rendered. You can obtain service by calling your vendor for a Returned Merchandise Authorization (RMA) number. For faster service, you may also obtain RMA authorizations online (<http://www.supermicro.com/RmaForm/>). When you return the motherboard to the manufacturer, the RMA number should be prominently displayed on the outside of the shipping carton, and mailed prepaid or hand-carried. Shipping and handling charges will be applied for all orders that must be mailed when service is complete.

This warranty only covers normal consumer use and does not cover damages incurred in shipping or from failure due to the alteration, misuse, abuse or improper maintenance of products.

During the warranty period, contact your distributor first for any product problems.

Chapter 4

BIOS

4-1 Introduction

This chapter describes the AMI BIOS setup utility for the X10SBA (-F). The ROM BIOS is stored in a Flash EEPROM and can be easily updated. This chapter describes the basic navigation of the AMI BIOS setup utility screens.



Note: For AMI BIOS recovery, please refer to the UEFI BIOS Recovery Instructions in Appendix C.

Starting BIOS Setup Utility

To enter the AMI BIOS setup utility screens, press the <Delete> key while the system is booting up.



Note: In most cases, the <Delete> key is used to invoke the AMI BIOS setup screen. There are a few cases when other keys are used, such as <F1>, <F2>, etc.

Each main BIOS menu option is described in this manual. The AMI BIOS setup menu screen has two main frames. The left frame displays all the options that can be configured. Grayed-out options cannot be configured. Options in blue can be configured by the user. The right frame displays the key legend. Above the key legend is an area reserved for a text message. When an option is selected in the left frame, it is highlighted in white. Often a text message will accompany it. (**Note:** the AMI BIOS has default text messages built in. Supermicro retains the option to include, omit, or change any of these text messages.)

The AMI BIOS setup utility uses a key-based navigation system called "hot keys." Most of the AMI BIOS setup utility "hot keys" can be used at any time during the setup navigation process. These keys include <F1>, <F4>, <Enter>, <Esc>, arrow keys, etc.



Note: Options printed in **Bold** are default settings.

How To Change the Configuration Data

The configuration data that determines the system parameters may be changed by entering the AMI BIOS setup utility. This setup utility can be accessed by pressing at the appropriate time during system boot.

How to Start the Setup Utility

Normally, the only visible Power-On Self-Test (POST) routine is the memory test. As the memory is being tested, press the <Delete> key to enter the main menu of the AMI BIOS setup utility. From the main menu, you can access the other setup screens. An AMI BIOS identification string is displayed at the left bottom corner of the screen, below the copyright message.

Warning: Do not upgrade the BIOS unless your system has a BIOS-related issue. Flashing the wrong BIOS can cause irreparable damage to the system. In no event shall Supermicro be liable for direct, indirect, special, incidental, or consequential damages arising from a BIOS update. If you have to update the BIOS, do not shut down or reset the system while the BIOS is updating. This is to avoid possible boot failure.

4-2 Main Setup

When you first enter the AMI BIOS setup utility, you will enter the Main setup screen. You can always return to the Main setup screen by selecting the Main tab on the top of the screen. The Main BIOS Setup screen is shown below.

The following Main menu items will be displayed:

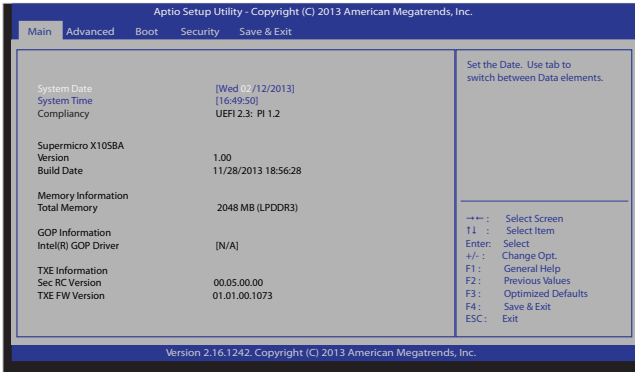

System Date/System Time

Use this option to change the system date and time. Highlight *System Date* or *System Time* using the arrow keys. Enter new values using the keyboard. Press the <Tab> key or the arrow keys to move between fields. The date must be entered in Day MM/DD/YYYY format. The time is entered in HH:MM:SS format.



Note: The time is in the 24-hour format. For example, 5:30 P.M. appears as 17:30:00.

Compliance: This item displays compliance information.

The following BIOS items will also be displayed:

Supermicro X10SBA**Version****Build Date****Memory Information**

Total Memory: This displays the total size of memory available in the system.

GOP Information

Intel® GOP Driver: This displays the information of Intel Graphics onboard driver.

TXE Information**Sec RC Version****TXE FW Version**

4-3 Advanced Setup Configurations

Use the arrow keys to select Advanced Setup and press <Enter> to access the submenu items:

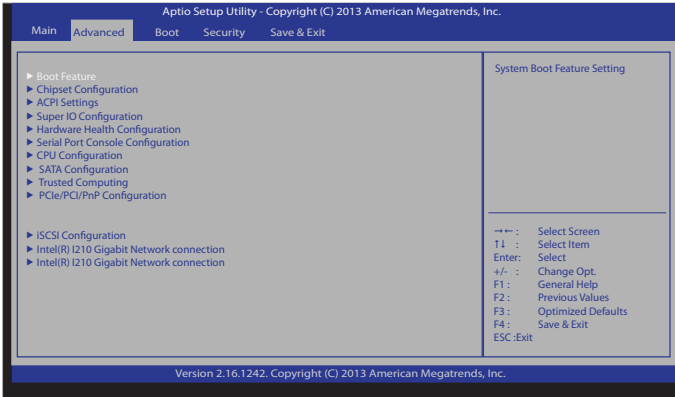

Warning: Take Caution when changing the Advanced settings. An incorrect value, a very high DRAM frequency or an incorrect DRAM timing setting may cause the system to become unstable. When this occurs, restore the setting to the manufacture default setting.

► Boot Feature

Quiet Boot

This feature selects the screen display between POST messages or the OEM logo at bootup. Select Disabled to display the POST messages. Select Enabled to display the OEM logo instead of the normal POST messages. The options are **Enabled** and Disabled.

AddOn ROM Display Mode

This feature sets the display mode for the Option ROM. Select Keep Current to use the current AddOn ROM display setting. Select Force BIOS to use the Option ROM display mode set by the system BIOS. The options are **Force BIOS** and Keep Current.

Bootup Num-Lock

This feature selects the Power-on state for the Numlock key. The options are Off and **On**.

Wait For 'F1' If Error

This feature forces the system to wait until the 'F1' key is pressed if an error occurs. The options are Disabled and **Enabled**.

Interrupt 19 Capture

Interrupt 19 is the software interrupt that handles the boot disk function. When this item is set to Enabled, the ROM BIOS of the host adaptors will "capture" Interrupt 19 at bootup and allow the drives that are attached to these host adaptors to function as bootable disks. If this item is set to Disabled, the ROM BIOS of the host adaptors will not capture Interrupt 19, and the drives attached to these adaptors will not function as bootable devices. The options are **Enabled** and Disabled.

Re-try Boot

If this item is enabled, the BIOS will automatically reboot the system from a specified boot device after its initial boot failure. The options are **Disabled**, Legacy Boot, and EFI Boot.

Power Configuration**Watch Dog Function**

If enabled, the Watch Dog timer will allow the system to reboot when it is inactive for more than 5 minutes. The options are Enabled and **Disabled**.

Power Button Function

This feature controls how the system shuts down when the power button is pressed. Select 4 Seconds Override for the user to power off the system after pressing and holding the power button for 4 seconds or longer. Select Instant Off to instantly power off the system as soon as the user presses the power button. The options are 4 Seconds Override and **Instant Off**.

Restore on AC Power Loss

Use this feature to set the power state after a power outage. Select Power-Off for the system power to remain off after a power loss. Select Power-On for the system power to be turned on after a power loss. Select Last State to allow the system to resume its last power state before a power loss. The options are Power-On, Stay-Off and **Last State**.

EuP Support

Select Enable for EuP Option support to enhance power performance. The options are Enabled and **Disabled**.

► Chipset Configuration

Warning! Setting the wrong values in the following sections may cause the system to malfunction.

► North Bridge

The following North Bridge information will be displayed:

► Graphics Configuration

This item displays the following graphics information:

GOP Configuration

GOP Driver

Select Enabled to enable GOP driver and to load the VBIOS. The options are **Enabled** and Disabled.

Graphics Configuration

Integrated Graphics Device

Select Enabled to support integrated graphics devices. The options are **Enabled** and Disabled.

IGD (Integrated Graphics Device) Turbo Enable

Select Enabled to enable the turbo mode support for integrated graphics devices. The options are **Enabled** and Disabled.

Primary Display

Use this feature to select the graphics device to be used as the primary display. The options are **Onboard** and offboard.

GFX Boost

Select Enabled to boost graphics performance. The options are **Disabled**, and Enabled.

DVMT (Dynamic Video Memory Technology) Pre-Allocated

Dynamic Video Memory Technology (DVMT) allows dynamic allocation of system memory to be used for video devices to ensure best utilization of available system memory based on the DVMT 5.0 platform. The options are **64M**, 96M, 128M, 160M, 192M, 224M, 256M, 288M, 320M, 352M, 384M, 416M, 448M, 480M, and 512M.

DVMT Total Gfx Mem

Use this feature to set the total memory size to be used by the internal graphics devices based on the DVMT 5.0 platform. The options are 128MB, **256MB** and MAX.

Aperture Size

Use this feature to set the Aperture size, which is the size of system memory reserved by the BIOS for graphics device use. The options are 128MB, **256MB** and 512 MB.

GTT Size

Use this feature to set the memory size to be used by the graphics translation table (GTT). The options are 1MB and **2MB**.

Spread Spectrum Clock

If this feature is set to Enabled, the BIOS will monitor the level of electromagnetic interference caused by the components and will attempt to reduce the interference whenever needed. The options are Enabled and **Disabled**.

Memory Information

The information of the following items will display:

- Total Memory
- Memory Frequency
- Memory SODIMM1
- Memory SODIMM2

►South Bridge

The following South Bridge information will be displayed:

►Azalia HD Audio**Audio Configuration****Audio Controller**

Select Enabled to enable the Azalia Audio Controller. The settings are **Enabled** and Disabled.

Azalia HDMI Codec

Select Enabled to enable the internal HDMI CODEC (Coder-Decoder) for Azalia. The settings are **Enabled** and Disabled.

►USB Configuration

Legacy USB Support

This feature enables support for legacy USB devices. Select Auto to disable legacy support if USB devices are not present. Select Disable to have USB devices available only for EFI applications. The options are **Enabled**, Disabled and Auto.

USB 3.0 Support

Select Enabled for USB 3.0 support. The options are Disabled and **Enabled**.

XHCI Hand-Off

This item is a work-around solution for operating systems that do not support XHCI (Extensible Host Controller Interface) hand-off. The XHCI ownership change should be claimed by the XHCI driver. The settings are **Enabled** and Disabled.

EHCI Hand-Off

This item is for operating systems that do not support Enhanced Host Controller Interface (EHCI) hand-off. When this item is enabled, EHCI ownership change will be claimed by the EHCI driver. The settings are Enabled and **Disabled**.

USB Mass Storage Driver Support

Select Enabled for USB mass storage device support. The options are Disabled and **Enabled**.

Port 60/64 Emulation

This feature enables or disables I/O port 60h/64h emulation support. This should be enabled for complete USB keyboard legacy support for the operating systems that do not support Legacy USB devices. The options are Disabled and **Enabled**.

XHCI Mode

Select Enabled to support the operation mode for the XHCI (Extensible Host Controller Interface) controller. The options are Enabled and **Disabled**.

USB Port 0

Select Enabled for USB Port 0 support. The options are **Enabled** and Disabled.

USB Port 1

Select Enabled for USB Port 1 support. The options are **Enabled** and Disabled.

USB Port 2

Select Enabled for USB Port 2 support. The options are **Enabled** and Disabled.

USB Port 3

Select Enabled for USB Port 3 support. The options are **Enabled** and Disabled.

►PCI Express Configuration

This item displays the information of onboard PCI-E slots.

PCI Express Port 0

This item enables or disables the PCI Express Port 0 on the motherboard. The options are **Enabled** and Disabled.

Speed

This feature allows the user to set the PCIe port speed. The options are Auto, **Gen 2** and Gen 1.

High Precision Timer

Select Enabled to activate the High Precision Event Timer (HPET) that produces periodic interrupts at a much higher frequency than a Real-time Clock (RTC) does in synchronizing multimedia streams, providing smooth playback and reducing the dependency on other timestamp calculation devices, such as an x86 RDTSC Instruction embedded in the CPU. The High Performance Event Timer is used to replace the 8254 Programmable Interval Timer. The options are **Enabled** and Disabled.

BIOS Read/Write Protection

If this feature is set to Enabled, BIOS Read/Write Protection will be enabled in the BIOS SPI region which will not allow any data to be read from or written into the SPI region to ensure data integrity in this region. The options are Enabled and **Disabled**.

►ACPI Settings

ACPI Sleep State

This feature selects the ACPI Sleep State that the system will enter into when the suspend button is activated. The options are Suspend Disabled, and **S3 only (Suspend to RAM)**.

High Precision Timer

Select Enabled to activate the High Precision Event Timer (HPET) that produces periodic interrupts at a much higher frequency than a Real-time Clock (RTC) does in synchronizing multimedia streams, providing smooth playback and reducing the de-

pendency on other timestamp calculation devices, such as an x86 RDTSC Instruction embedded in the CPU. The High Performance Event Timer is used to replace the 8254 Programmable Interval Timer. The options are **Enabled** and Disabled.

Boot Timer with HPET Timer (High Precision Event Timer)

Select Enabled to allow the Boot Timer to take the input from the High Precision Time into calculation when calculating time events for the system. The options are Enabled and **Disabled**.

►Super IO Configuration

Super IO Chip NCT5104DSEC

►Serial Port 1 Configuration/Serial Port 2 Configuration/Serial Port 3 Configuration//Serial Port 4 Configuration

Serial Port

Select Enabled to enable the onboard serial port specified by the user. The options are **Enabled** and Disabled.

Device Settings

This item displays the base I/O port address and the Interrupt Request address of a serial port specified by the user.

Change Settings

This feature specifies the base I/O port address and the Interrupt Request address of Serial Port 1, Serial Port 2, Serial Port 3, or Serial Port 4. Select Auto to allow the BIOS to automatically assign the base I/O and IRQ address to a serial port specified.

The options for Serial Port 1 are **Auto**, (IO=3F8h; IRQ=4), (IO=3F0h; IRQ=3, 4, 5, 6, 7, 10, 11, 12), (IO=3E0h; IRQ=3, 4, 5, 6, 7, 10, 11, 12), and (IO=3D0h; IRQ=3, 4, 5, 6, 7, 10, 11, 12).

The options for Serial Port 2 are **Auto**, (IO=2F8h; IRQ=4), (IO=3F0h; IRQ=3, 4, 5, 6, 7, 10, 11, 12), (IO=3E0h; IRQ=3, 4, 5, 6, 7, 10, 11, 12), and (IO=3D0h; IRQ=3, 4, 5, 6, 7, 10, 11, 12).

The options for Serial Port 3 are **Auto**, (IO=3E0h; IRQ=4), (IO=3F0h; IRQ=3, 4, 5, 6, 7, 10, 11, 12), (IO=3E0h; IRQ=3, 4, 5, 6, 7, 10, 11, 12), and (IO=3D0h; IRQ=3, 4, 5, 6, 7, 10, 11, 12).

The options for Serial Port 4 are **Auto**, (IO=2E0h; IRQ=4), (IO=3F0h; IRQ=3, 4, 5, 6, 7, 10, 11, 12), (IO=3E0h; IRQ=3, 4, 5, 6, 7, 10, 11, 12), and (IO=3D0h; IRQ=3, 4, 5, 6, 7, 10, 11, 12).

► Hardware Health Configuration

PC Health Status

Fan Speed Control Mode

This feature allows the user to decide how the system controls the speeds of the onboard fans. The CPU temperature and the fan speed are correlative. When the CPU on-die temperature increases, the fan speed will also increase for effective system cooling. Select "Full Speed" to allow the onboard fans to run at full speed (of 100% Pulse Width Modulation Duty Cycle) for maximum cooling. This setting is recommended for special system configuration or debugging. Select "Standard" for the onboard fans to run at 50% of the Initial PWM Cycle in order to balance the needs between system cooling and power saving. This setting is recommended for regular systems with normal hardware configurations. The options are Full Speed (@100% of PWM Cycle), **Standard** (@50% of PWM Cycle), Heavy I/O, and PUE (Power Usage Efficiency).

The following items will be displayed:

- Peripheral Temperature
- Fan 1 Speed
- Fan 2 Speed
- 3VCC
- AVCC
- VSB3v
- VBAT

►Serial Port Console Redirection

COM0

Use this feature to enable console redirection for the COM0 port. The options are **Enabled** and **Disabled**.

►Console Redirection Settings

This feature allows the user to specify how the host computer will exchange data with the client computer, which is the remote computer used by the user.

Terminal Type

This feature allows the user to select the target terminal emulation type for Console Redirection. Select VT100 to use the ASCII Character set. Select VT100+ to add color and function key support. Select ANSI to use the Extended ASCII Character Set. Select VT-UTF8 to use UTF8 encoding to map Unicode characters into one or more bytes. The options are ANSI, VT100, **VT100+**, and VT-UTF8.

Bits Per second

Use this feature to set the transmission speed for a serial port used in Console Redirection. Make sure that the same speed is used in the host computer and the client computer. A lower transmission speed may be required for long and busy lines. The options are 9600, 19200, 38400, 57600 and **115200** (bits per second).

Data Bits

Use this feature to set the data transmission size for Console Redirection. The options are 7 Bits and **8 Bits**.

Parity

A parity bit can be sent along with regular data bits to detect data transmission errors. Select Even if the parity bit is set to 0, and the number of 1's in data bits is even. Select Odd if the parity bit is set to 0, and the number of 1's in data bits is odd. Select None if you do not want to send a parity bit with your data bits in transmission. Select Mark to add a mark as a parity bit to be sent along with the data bits. Select Space to add a Space as a parity bit to be sent with your data bits. The options are **None**, Even, Odd, Mark and Space.

Stop Bits

A stop bit indicates the end of a serial data packet. Select 1 Stop Bit for standard serial data communication. Select 2 Stop Bits if slower devices are used. The options are **1** and **2**.

Flow Control

This feature allows the user to set the flow control for Console Redirection to prevent data loss caused by buffer overflow. Send a "Stop" signal to stop sending data when the receiving buffer is full. Send a "Start" signal to start sending data when the receiving buffer is empty. The options are **None** and Hardware RTS/CTS.

VT-UTF8 Combo Key Support

Select Enabled to enable VT-UTF8 Combination Key support for ANSI/VT100 terminals. The options are **Enabled** and Disabled.

Recorder Mode

Select Enabled to capture the data displayed on a terminal and send it as text messages to a remote server. The options are **Disabled** and Enabled.

Resolution 100x31

Select Enabled for extended-terminal resolution support. The options are Disabled and **Enabled**.

Legacy OS Redirection Resolution

Use this feature to select the number of rows and columns used in Console Redirection for legacy OS support. The options are **80x24** and 80x25.

Putty KeyPad

This feature selects Function Keys and KeyPad settings for Putty, which is a terminal emulator designed for the Windows OS. The options are **VT100**, LINUX, XTERMR6, SC0, ESCN, and VT400.

Redirection After BIOS Post

Use this feature to enable or disable Legacy Console Redirection after BIOS POST. When this item is set to Bootloader, Legacy Console Redirection is disabled before booting the OS. When set to Always Enable, Legacy Console Redirection remains enabled when booting the OS. The options are **Always Enable** and Bootloader.

Serial Port for Out-of-Band Management/Windows Emergency Management Services (EMS)

The submenu allows the user to configure Console Redirection settings to support Out-of-Band Serial Port management.

Console Redirection (for EMS)

Select Enabled to use a COM port selected by the user for Console Redirection. The options are Enabled and **Disabled**.

► Console Redirection Settings (for EMS)

This feature allows the user to specify how the host computer will exchange data with the client computer, which is the remote computer used by the user.

Out-of-Band Management Port

The feature selects a serial port used by the Microsoft Windows Emergency Management Services (EMS) to communicate with a remote server. The default setting is **COM0**.

Terminal Type

This feature allows the user to select the target terminal emulation type for Console Redirection. Select VT100 to use the ASCII character set. Select VT100+ to add color and function key support. Select ANSI to use the extended ASCII character set. Select VT-UTF8 to use UTF8 encoding to map Unicode characters into one or more bytes. The options are ANSI, VT100, VT100+, and **VT-UTF8**.

Bits Per Second

This item sets the transmission speed for a serial port used in Console Redirection. Make sure that the same speed is used in the host computer and the client computer. A lower transmission speed may be required for long and busy lines. The options are 9600, 19200, 57600, and **115200** (bits per second).

Flow Control

This feature allows the user to set the flow control for Console Redirection to prevent data loss caused by buffer overflow. Send a "Stop" signal to stop sending data when the receiving buffer is full. Send a "Start" signal to start sending data when the receiving buffer is empty. The options are **None**, Hardware RTS/CTS, and Software Xon/Xoff.

Data Bits, Parity, Stop Bits

The status of each item above is displayed.

►CPU Configuration

►Socket 0 CPU Configuration

The following CPU information will be displayed:

- Type of CPU
- CPU Signature
- Microcode Patch
- Max (Maximum) CPU Speed
- Min (Minimum) CPU Speed
- Processor Cores
- Intel HT(Hyper-Threading) Technology
- Intel VT-x (Virtualization) Technology
- L1 Data Cache
- L1 Code Cache
- L2 Cache
- L3 Cache

64-bit: This item indicates whether 64-bit is supported by the processor.

Active Processor Cores

This feature determines how many CPU cores will be activated for each CPU. When all is selected, all cores in the CPU will be activated. (Please refer to Intel's web site for more information.) The options are **All**, and 1.

Limit CPUID Maximum

Select Enabled to set the maximum CPU ID value and to boot a legacy OS that cannot support processors with extended CPUID functions. The options are Enabled and **Disabled** (for the Windows OS).

Execute Disable Bit (Available if supported by the OS & the CPU)

Set to Enabled to enable the Execute Disable Bit to allow the processor to designate areas in the system memory where an application code can execute and where it

cannot, thus preventing a worm or a virus from flooding illegal codes to overwhelm the processor or damage the system during an attack. The default is **Enabled**. (Refer to Intel and Microsoft Web Sites for more information.)

Hardware Prefetcher (Available when supported by the CPU)

If set to Enabled, the hardware prefetcher will prefetch streams of data and instructions from the main memory to the L2 cache to improve CPU performance. The options are Disabled and **Enabled**.

Adjacent Cache Line Prefetch (Available when supported by the CPU)

Select Enabled for the CPU to prefetch both cache lines for 128 bytes as comprised. Select Disabled for the CPU to prefetch both cache lines for 64 bytes. The options are Disabled and **Enabled**.



Note: If there is any change to this setting, you will need to power off and reboot the system for the change to take effect. Please refer to Intel's web site for detailed information.

Intel® Virtualization Technology (Available when supported by the CPU)

Select Enabled to use the Intel Virtualization Technology to allow one platform to run multiple operating systems and applications in independent partitions, creating multiple "virtual" systems in one physical computer. The options are **Enabled** and Disabled.

Power Technology

This feature allows the user to configure power management settings. The options are Disabled, **Energy Efficiency**, and Custom.

►SATA Configuration

When this submenu is selected, the AMI BIOS automatically detects the presence of the SATA Devices and displays the following items:

Serial-ATA (SATA)

Select Enabled to enable onboard SATA support. The options are **Enabled** and Disabled.

SATA Test Mode Selection

Select Enabled to support SATA Test Mode Selection. The options are Enabled, and **Disabled**.

SATA Mode (Available when the item: Serial-ATA is enabled)

This item selects the mode for the installed SATA drives. The options are IDE Mode, and **AHCI Mode**.

If the item above -SATA Mode Select is set to AHCI, the following items are displayed:

Serial-ATA Port 0/ Serial-ATA Port 1

Select Enabled to enable a SATA port specified by the user. The options are **Enabled** and Disabled.

If the item above - SATA Mode Select is set to IDE, the following items are displayed:

Serial-ATA Port 0/ Serial-ATA Port 1

Select Enabled to enable a SATA port specified by the user. The options are **Enabled** and Disabled.

► Trusted Computing (Available when a TPM device is detected by the BIOS)**Configuration****Security Device Support**

If this feature and the TPM jumper on the motherboard are both set to Enabled, onboard security devices will be enabled for TPM support to enhance data integrity and network security. Please reboot the system for a change on this setting to take effect. The options are Enabled and **Disabled**.

TPM State

Select Enabled to use TPM (Trusted Platform Module) settings to enhance system data security. Please reboot your system for any change on the TPM state to take effect. The options are Disabled and **Enabled**.

Pending Operation

Use this item to schedule a TPM-related operation to be performed by a security device for system data integrity. Your system will reboot to carry out a pending TPM operation. The options are **None**, Enable Take Ownership, Disable Take Ownership, and TPM Clear.



Note: Your system will reboot to carry out a pending TPM operation.

Current Status Information

This item displays the status of the TPM support on this motherboard.

►PCIe/PCI/PnP Configuration

This feature allows the user to set the PCI/PnP configurations for the following items:

VGA Palette Snoop

Select Enabled to support VGA palette register snooping which will allow the PCI cards that do not contain their own VGA color palette to examine the video cards palette and mimic it for proper color display. The options are **Disabled** and Enabled.

Above 4G Decoding

Select Enabled for 64-bit devices to be decoded above the 4GB address space. If 64bit PCI decoding is supported by the system. The options are **Disabled** and Enabled.

Marvell SATA Controller

Select Enabled to support the onboard Marvell SATA controller to use PEX8605 Port 3. The options are **Enabled** and Disabled.

Onboard LAN1/Onboard LAN2

Select Enabled to enable a LAN port specified by the user. The options are **Enabled** and Disabled.

Option ROM Execution Policy

Video OPROM

This feature controls how the system executes UEFI (Unified Extensible Firmware Interface), and Legacy Video OPROM. Select Legacy Only to boot the system using a legacy video device installed on the motherboard. The options are Do Not Launch, UEFI Only and **Legacy Only**.

Storage OPROM

This feature controls how the system executes UEFI (Unified Extensible Firmware Interface), and Legacy Storage OPROM. Select Legacy Only to boot the system using a legacy storage device installed on the motherboard. The options are Do Not Launch, UEFI Only and **Legacy Only**.

Other PCI Device ROM

This feature selects a PCI device OPROM to launch for system boot if this device is not a network, mass storage, or video device. The options are UEFI Only and **Legacy Only**.

Slot1 PCI-E 2.0 x2 (in x8) OPROM

Use this feature to enable or disable PCI-Express slot Option ROM support to boot the computer using a device installed on the slot specified by the user. The options are Disabled, **Legacy**, EFI, and EFI and Legacy.

Onboard LAN1 Option ROM/Onboard LAN2 Option ROM

Select iSCSI to use the iSCSI Option ROM to boot the computer using an iSCSI device installed in a LAN port specified. Select PXE (Preboot Execution Environment) to boot the computer using a PXE device installed in a LAN port specified. Select Disabled to prevent system boot using a device installed in a LAN port. The options for Onboard LAN1 Option ROM are Disabled, **PXE** and iSCSI. The options for Onboard LAN2 Option ROM are **Disabled**, and PXE.

Network Stack

Select Enabled to enable PXE (Preboot Execution Environment) or UEFI (Unified Extensible Firmware Interface) for network stack support. The options are Enabled and **Disabled**.

Ipv4 PXE Support (Available when Network Stack is set to Enabled)

Select Enabled to enable Ipv4 PXE (Preboot Execution Environment) for boot support. If this feature is set to Disabled, Ipv4 PXE boot option will not be supported. The options are **Enabled** and Disabled.

►iSCSi Configuration

iSCSI Initiator Name

This feature allows the user to enter the unique name of the iSCSI Initiator in IQN format. Once the name of the iSCSI Initiator is entered into the system, configure the proper settings for the following items.

►Add an Attempt

►Delete Attempts

►Change Attempt order

►Intel®I210 Gigabit Network Connection--00:25:90:90..

PORT CONFIGURATION MENU

►NIC Configuration

Link Speed

This feature allows the user to set the Network Interface Connection speed for a LAN port specified by the user. The options are **Auto Negotiated**, 10 Mbps Half, 10 Mbps Full, 100 Mbps Half, and 10 Mbps Full.

Wake On LAN

Select Enabled for Wake_On_LAN support, which will allow the system to "wake up" when an onboard LAN device receives an incoming signal. The options are **Enabled** and Disabled.

Blink LEDs

This feature indicates the LAN ports that are connected to the network using blinking LED indicators.

PORT CONFIGURATION INFORMATION

The following port configuration information will be displayed:

UEFI Driver:

Adapter PBA:

Chip Type:

PCI Device ID:

Bus: Device: Function:

Link Status

MAC Address:

Virtual MAC Address:

4-4 Security Settings

This menu allows the user to configure the following security settings for the system.

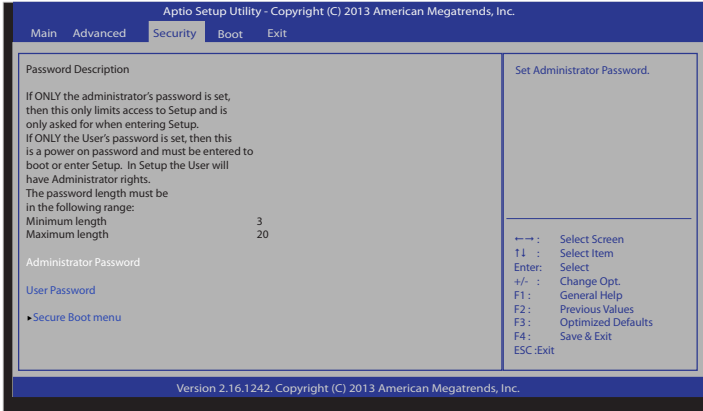

Administrator Password

Use this feature to set the administrator password which is required to enter the BIOS setup utility. The length of the password should be from 3 characters to 20 characters long.

User Password

Use this feature to set a user password which is required to log into the system and to enter the BIOS setup utility. The length of the password should be from 3 characters to 20 characters long.

► Secure Boot Menu

Secure Boot

Select Enable for secure boot support to ensure system security at bootup. The options are Enabled and **Disabled**.

Secure Boot Mode

This feature allows the user to select the desired secure boot mode for the system. The options are Standard and **Custom**.

►Key Management**Default Keys Provision**

Select Enable to install all manufacture defaults for the following system security settings. The options are **Disabled** and Enabled.

►Delete All Secure Boot Variables

This feature allows the user to delete all secure boot settings previous stored in the system.

►Save All Secure Boot Variables

This feature allows the user to save the secure boot settings specified by the user.

Enroll All Factory Default Keys

This feature allows the user to store security-related boot data in a file of the same named in the system root folder of your computer.

Platform Key (PK)**►Delete PK**

Select <Yes> to confirm deletion of the Platform Key (PK) from the NVRAM (Non-Volatile RAM).

►Set New Key

Select <Yes> to load the manufacture_default platform keys for your system. Select No to load the default settings from other sources.

Key Exchange Key (KEK)**►Delete KEK (Key Exchange Key)**

Select <Yes> to confirm deletion of the KEK from the NVRAM (Non-Volatile RAM)..

►Set New KEK (Key Exchange Key)

Select <Yes> to confirm that a new KEK will be set in the NVRAM (Non-Volatile RAM)..

►Append KEK (Key Exchange Key)

Select <Yes> to load the new KEK from the manufacture defaults. Select <No> to load the new KEK from other sources.

Authorized Signatures

▶Delete DB (DataBase)

Select <Yes> to confirm deletion of a database from the NVRAM (Non-Volatile RAM).

▶Set New DB (DataBase)

Select <Yes> to confirm that a new database will be set in the NVRAM (Non-Volatile RAM).

▶Append DB (DataBase)

Select <Yes> to load the new database from the manufacture defaults. Select <No> to load the new database from other sources

Authorized TimeStamps

▶Delete DBT (DataBase Timer)

Select <Yes> to confirm deletion of the database timer from the NVRAM (Non-Volatile RAM).

▶Set New DBT (DataBase Timer)

Select <Yes> to confirm that the new database timer will be set in the NVRAM (Non-Volatile RAM).

▶Append DBT (DataBase Timer)

Select <Yes> to load the new database timer from the manufacture defaults. Select <No> to load the new database timer from other sources

Forbidden Signatures

▶Delete DBX

Select <Yes> to confirm deletion of the DBX files from the Non-Volatile RAM (NVRAM).

▶Set New DBX

Select <Yes> to confirm that the new DBX files will be downloaded to the Non-Volatile RAM (NVRAM).

▶Append DBX (DataBase Timer)

Select <Yes> to load the new DBX files from the manufacture defaults. Select <No> to load the new DBX files from other sources.

4-5 Boot Settings

Use this feature to configure Boot Settings:

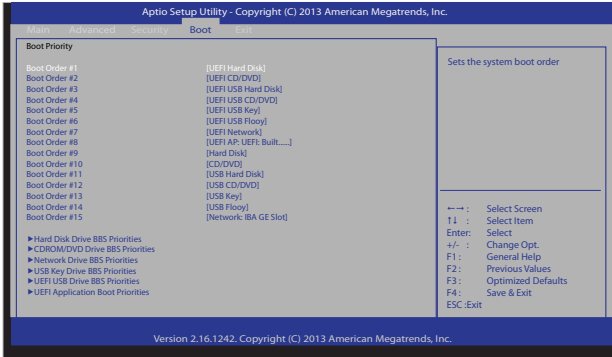

Set Boot Priority

This option prioritizes the order of bootable devices that the system to boot from. Press [ENTER] on each entry from top to bottom to select devices.

- Boot Order #1
- Boot Order #2
- Boot Order #3
- Boot Order #4
- Boot Order #5
- Boot Order #6
- Boot Order #7
- Boot Order #8
- Boot Order #9

▶ **Hard Disk Drive BBS Priorities**

- Boot Order #1

▶ **CDROM/DVD Drive BBS Priorities**

- Boot Order #1

▶ **Network Drive BBS Priorities**

- Boot Order #1

▶ **USB Key Drive BBS Priorities**

- Boot Order #1

▶ **UEFI USB Key Drive BBS Priorities**

- Boot Order #1

▶ **UEFI Application Boot Priorities**

- Boot Order #1

4-6 Save & Exit

Select the Exit tab from the BIOS setup utility screen to enter the Exit BIOS Setup screen.

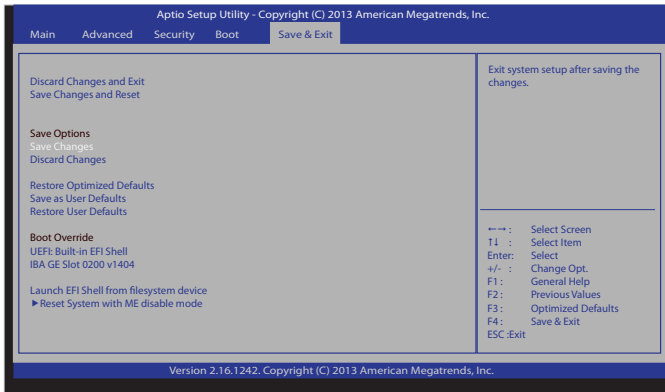

Discard Changes and Exit

Select this option to quit the BIOS Setup without making any permanent changes to the system configuration, and reboot the computer. Select Discard Changes and Exit from the Exit menu and press <Enter>.

Save Changes and Reset

When you have completed the system configuration changes, select this option to leave the BIOS setup utility and reboot the computer for the new system configuration parameters can take effect. Select Save Changes and Exit from the Exit menu and press <Enter>.

Save Options

Save Changes

When you have completed the system configuration changes, select this option to save all changes made. This will not reset (reboot) the system.

Discard Changes

Select this option and press <Enter> to discard all the changes and return to the AMI BIOS Utility Program.

Restore Defaults

To set this feature, select Restore Defaults from the Exit menu and press <Enter>. These are factory settings designed for maximum system performance but not for maximum stability.

Save As User Defaults

To set this feature, select Save as User Defaults from the Exit menu and press <Enter>. This enables the user to save any changes to the BIOS setup for future use.

Restore User Defaults

To set this feature, select Restore User Defaults from the Exit menu and press <Enter>. Use this feature to retrieve user-defined settings that were saved previously.

Boot Override

This feature allows the user to override the Boot Option Priorities sequence in the Boot menu, and immediately boot the system with another device specified by the user. This is a one-time override.

UEFI: Built-in EFI Shell

IBA GE Slot 0200 v1404

Launch EFI Shell from filesystem device

Select this item and press <Enter> launch EFI Shell for your computer.

Reset System with ME Disable Mode

Select this item and press <Enter> to reset your system when your system is in Manufacture (ME) Disabled mode.

Appendix A

BIOS Error Beep Codes

During the POST (Power-On Self-Test) routines, which are performed each time the system is powered on, errors may occur.

Non-fatal errors are those which, in most cases, allow the system to continue with bootup. The error messages normally appear on the screen.

Fatal errors will not allow the system to continue to bootup. If a fatal error occurs, you should consult with your system manufacturer for possible repairs.

These fatal errors are usually communicated through a series of audible beeps. The numbers on the fatal error list correspond to the number of beeps for the corresponding error.

A-1 BIOS Error Beep Codes

BIOS Error Beep Codes		
Beep Code/LED	Error Message	Description
1 beep	Refresh	Circuits have been reset. (Ready to power up)
5 short beeps + 1 long beep	Memory error	No memory detected in the system
5 beeps	Display memory read/write error	Video adapter missing or with faulty memory
OH LED On	System OH	System Overheat

Notes

Appendix B

Software Installation Instructions

B-1 Installing Drivers

After you've installed the Windows Operating System, a screen as shown below will appear. You are ready to install software programs and drivers that have not yet been installed. To install these software programs and drivers, click the icons to the right of these items. (**Note:** To install the Windows Operating System, please refer to the instructions posted on our website at <http://www.supermicro.com/support/manuals/>.)

SUPERMICRO®

Drivers & Tools

**Intel® Celeron®
Processor
J1900 (SoC)**

X10SBA/-L



Driver/Tool Installation Display Screen



Note 1: Click the icons showing a hand writing on the paper to view the readme files for each item. Click on a computer icon to the right of an item to install this item (from top to the bottom), one at a time. After installing each item, you must reboot the system before proceeding with the next item on the list. The bottom icon with a CD on it allows you to view the entire contents of the CD.

Note 2: When making a storage driver diskette by booting into a Driver CD, please set the SATA Configuration to "Compatible Mode" and configure SATA as IDE in the BIOS Setup. After making the driver diskette, be sure to change the SATA settings back to your original settings.

B-2 Configuring SuperDoctor 5

The Supermicro SuperDoctor[®] 5 is a program that functions in a command-line or web-based interface in Windows and Linux operating systems. The program monitors system health information such as CPU temperature, system voltages, system power consumption, fan speed, and provides alerts via email or Simple Network Management Protocol (SNMP).

SuperDoctor 5 comes in local and remote management versions and can be used with Nagios to maximize your system monitoring needs. With SuperDoctor 5 Management Server (SSM Server), you can remotely control power on/off and reset chassis intrusion for multiple systems with SuperDoctor 5 or IPMI. SD5 Management Server monitors HTTP, FTP, and SMTP services to optimize the efficiency of your operation.

 **Note:** The default User Name and Password for SuperDoctor 5 is admin / admin.

SuperDoctor[®] 5 Interface Display Screen (Health Information)

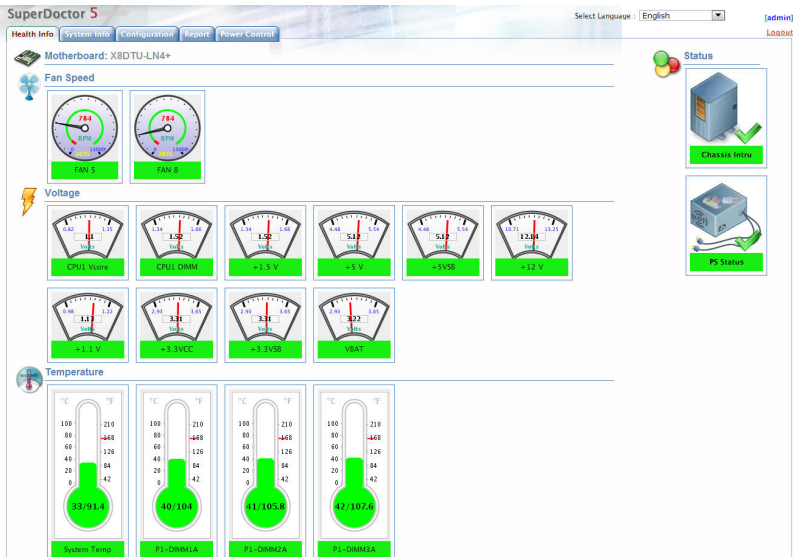

 **Note:** The SuperDoctor 5 program and User's Manual can be downloaded from the Supermicro web site at http://www.supermicro.com/products/nfo/sms_sd5.cfm. For Linux, we still recommend that you use SuperDoctor II, this version is also available for download at the link above.

Appendix C

UEFI BIOS Recovery Instructions

Warning: Do not upgrade the BIOS unless your system has a BIOS-related issue. Flashing the wrong BIOS can cause irreparable damage to the system. In no event shall Supermicro be liable for direct, indirect, special, incidental, or consequential damages arising from a BIOS update. If you need to update the BIOS, do not shut down or reset the system while the BIOS is updating to avoid possible boot failure.

C-1 An Overview to the UEFI BIOS

The Unified Extensible Firmware Interface (UEFI) specification provides a software-based interface between the operating system and the platform firmware in the pre-boot environment. The UEFI specification supports an architecture-independent mechanism for add-on card initialization to allow the UEFI OS loader, which is stored in the add-on card, to boot up the system. UEFI offers a clean, hand-off control to a computer system at bootup.

C-2 How to Recover the UEFI BIOS Image (-the Main BIOS Block)

A UEFI BIOS flash chip consists of a recovery BIOS block, which consists of two boot blocks and a main BIOS block (a main BIOS image). The boot block contains critical BIOS codes, including memory detection and recovery codes for the user to flash a new BIOS image if the original main BIOS image is corrupted. When the system power is on, the boot block codes execute first. Once it is completed, the main BIOS code will continue with system initialization and bootup.



Note: Follow the BIOS Recovery instructions below for BIOS recovery when the main BIOS block crashes. However, when the BIOS Boot block crashes, you will need to follow the procedures in Appendix A.

C-3 To Recover the Main BIOS Block Using a USB-Attached Device

This feature allows the user to recover a BIOS image using a USB-attached device without additional utilities used. A USB flash device such as a USB Flash Drive, or a USB CD/DVD ROM/RW device can be used for this purpose. However, a USB Hard Disk drive cannot be used for BIOS recovery at this time.

To perform UEFI BIOS recovery using a USB-attached device, follow the instructions below.

1. Using a different machine, copy the "Super.ROM" binary image file into the disc Root "\" Directory of a USB device or a writeable CD/DVD.



Note: If you cannot locate the "Super.ROM" file in your driver disk, visit our website at www.supermicro.com to download the BIOS image into a USB flash device and rename it to "Super ROM" for BIOS recovery use.

2. Insert the USB device that contains the new BIOS image ("Super.ROM") into your USB drive and power on the system
3. While powering on the system, keep pressing <Ctrl> and <Home> simultaneously on your keyboard until you hear two short beeps. This may take from a few seconds to one minute.
4. After locating the new BIOS binary image, the system will enter the BIOS Recovery menu as shown below.



Note: At this point, you may decide if you want to start with BIOS Recovery. If you decide to proceed with BIOS Recovery, follow the procedures below.

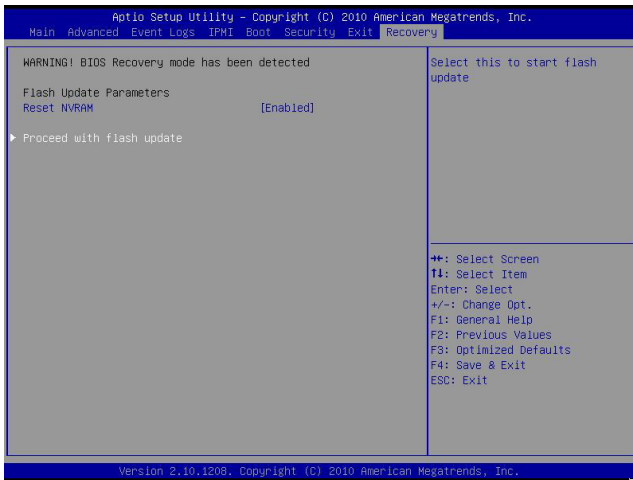

5. When the screen as shown above displays, using the arrow key, select the item- "Proceed with flash update" and press the <Enter> key. You will see the progress of BIOS Recovery as shown in the screen below.



Note: Do not interrupt the process of BIOS flashing until it is completed.

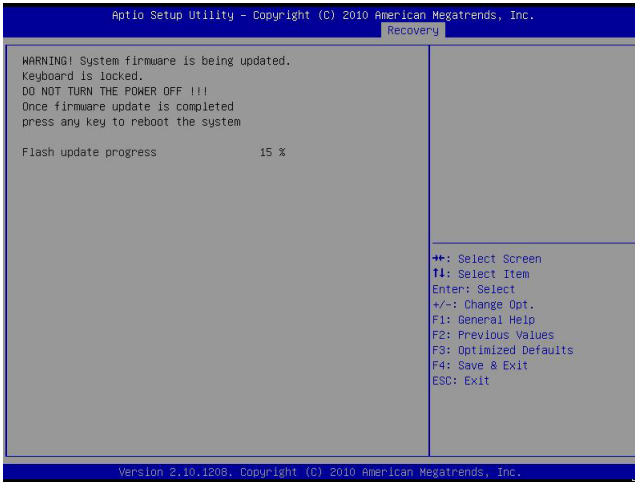

- After the process of BIOS Recovery is complete, press any key to reboot the system.

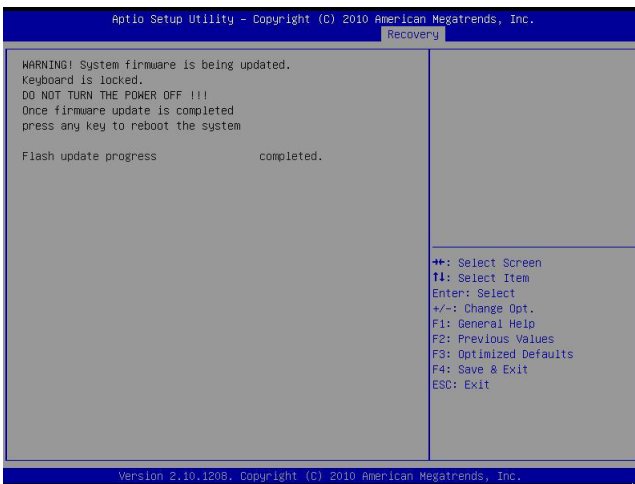

- Using a different system, extract the BIOS package into a bootable USB flash drive.
- When a DOS prompt appears, enter `AMI.BAT BIOSname.###` at the prompt.



Note: Do not interrupt this process until BIOS flashing is completed.

9. After seeing the message that BIOS update is completed, unplug the AC power cable from the power supply to clear CMOS, and then plug the AC power cable in the power supply again to power on the system.
10. Press continuously to enter the BIOS Setup utility.
11. Press <F3> to load default settings.
12. After loading default settings, press <F4> to save the settings and exit the BIOS Setup utility.

Appendix D

Dual Boot Block

D-1 Introduction

This motherboard supports the Dual Boot Block feature, which is the last-ditch mechanism to recover the BIOS boot block. This section provides an introduction to the feature.

BIOS Boot Block

A BIOS boot block is the minimum BIOS loader required to enable necessary hardware components for the BIOS crisis recovery flash that will update the main BIOS block. An on-call BIOS boot-block corruption may occur due to a software tool issue (see image below) or an unexpected power outage during BIOS updates.

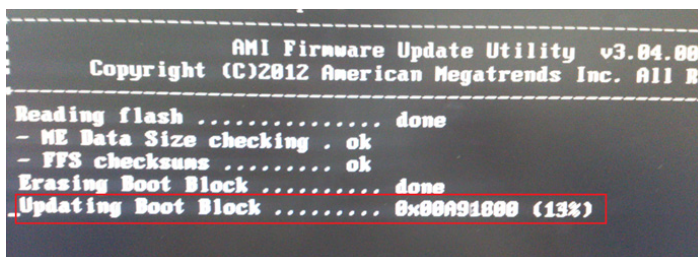

```
-----  
                AMI Firmware Update Utility v3.04.00  
                Copyright (C)2012 American Megatrends Inc. All Rights Reserved  
-----  
Reading flash ..... done  
- ME Data Size checking . ok  
- FFS checksums ..... ok  
Erasing Boot Block ..... done  
Updating Boot Block ..... 6x88A91800 (13%)
```

BIOS Boot Block Corruption Occurrence

When a BIOS boot block is corrupted due to an unexpected power outage or a software tool malfunctioning during BIOS updates, you can still reboot the system by closing pins 2 and 3 using a cap on Jumper JBR1. When JBR1 is set to pins 2 and 3, the system will boot from a backup boot block pre-loaded in the BIOS by the manufacturer.

D-2 Steps to Reboot the System by Using Jumper JBR1

1. Power down the system.
2. Close pins 2-3 on Jumper JBR1, and power on the system.
3. Follow the BIOS recovery SOP listed in the previous chapter (Appendix C).
4. After completing the steps above, power down the system.
5. Close pins 1-2 on Jumper JBR1, and power on the system.

(Disclaimer Continued)

The products sold by Supermicro are not intended for and will not be used in life support systems, medical equipment, nuclear facilities or systems, aircraft, aircraft devices, aircraft/emergency communication devices or other critical systems whose failure to perform be reasonably expected to result in significant injury or loss of life or catastrophic property damage. Accordingly, Supermicro disclaims any and all liability, and should buyer use or sell such products for use in such ultra-hazardous applications, it does so entirely at its own risk. Furthermore, buyer agrees to fully indemnify, defend and hold Supermicro harmless for and against any and all claims, demands, actions, litigation, and proceedings of any kind arising out of or related to such ultra-hazardous use or sale.