

LP-173

Pico-ITX

User's Manual

2014/09/02

Version:1.1

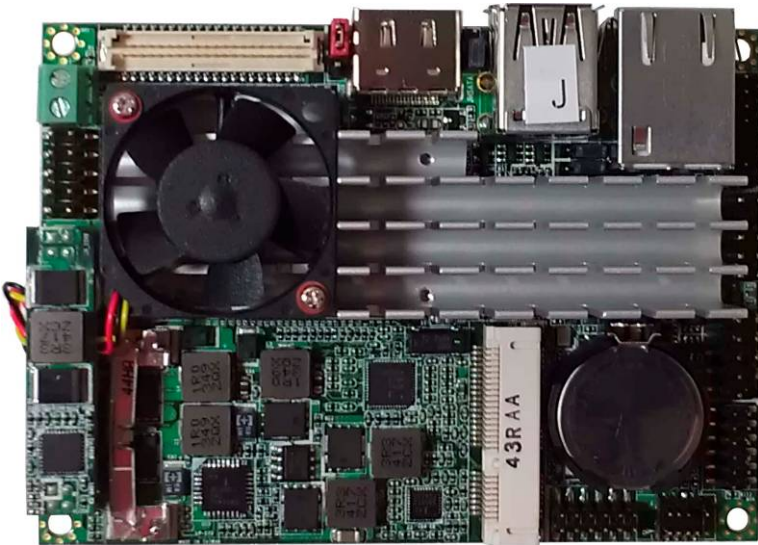

Copyright

Copyright 2012. All rights reserved. This document is copyrighted and all rights are reserved. The information in this document is subject to change without prior notice to make improvements to the products.

This document contains proprietary information and protected by copyright. No part of this document may be reproduced, copied, or translated in any form or any means without prior written permission of the manufacturer.

All trademarks and/or registered trademarks contains in this document are property of their respective owners.

Disclaimer

The company shall not be liable for any incidental or consequential damages resulting from the performance or use of this product.

The company does not issue a warranty of any kind, express or implied, including without limitation implied warranties of merchantability or fitness for a particular purpose.

The company has the right to revise the manual or include changes in the specifications of the product described within it at any time without notice and without obligation to notify any person of such revision or changes.

Trademark

All trademarks are the property of their respective holders.

Any questions please visit our website at <http://www.commell.com.tw>

Packing List:

Please check the package content before you starting using the board.

Hardware:

LP-173 Pico-ITX Miniboard x 1

Cable Kit:

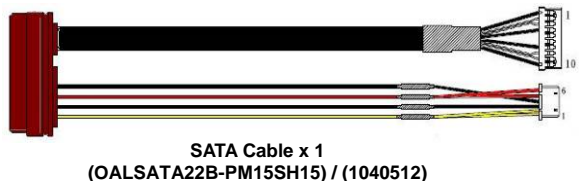
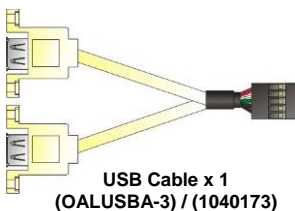



RS232 Cable x 1
(OALE5-BKU2-H14NB) / (1040379)



DC_IN Power Cable x 1
(OALDC-B) / (1040513)

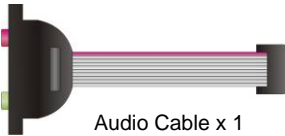

Audio Cable x 1
(OALPJ-HDUNB) / (1040123)



PS/2 Keyboard & Mouse Cable x 1
(OALPS2/KM) / (1040131)



CRT cable without bracket x 1
(OALVGA-SNB-7) / (1040557)

Printed Matters:

Driver CD x 1 (Including User's Manual)

Index

Chapter 1 <Introduction>	5
1.1 <Product Overview>.....	5
1.2 <Product Specification>	6
1.3 <Mechanical Drawing>	7
1.4 <Block Diagram>	8
Chapter 2 <Hardware Setup>	9
2.1 <Connector Location>	9
2.2 <Jumper Reference>.....	10

2.3 <Connector Reference>	10
2.3.1 <Internal Connector>	10
2.3.2 <External Connector>	10
2.4 <Memory Setup>	11
2.5 <CMOS & ATX Setup>	11
2.6 <SATA Interface>	12
2.7 <LAN Interface>	12
2.8 <Onboard Display Interface>	12
2.8.1 <Analog VGA Interface>	12
2.8.2 <CN_LVDS>	13
2.9 <Onboard Audio Interface>	16
2.10 <USB 3.0 and USB 2.0Interface>	17
2.11 <Serial Port Jumper Setting >	19
2.12 <Power & FAN Connector >	20
2.12.1 <Power Input>	20
2.12.2 <Power Output>	21
2.12.3 <Fan Connector>	21
2.13 <Indicator and Switch>	22
2.14 < PCIE Mini Card >	23
Chapter 3 <BIOS Setup>	24
Appendix A <I/O Port Pin Assignment>	25
A.1 <SATA Port>	25
A.2 <LAN Port>	25
A.3 <LPC Port>	26
A.4 <GPIO Port>	26
Appendix B <Flash BIOS>	27
B.1 BIOS Auto Flash Tool	27
B.2 Flash Method	27
Appendix C <Programming GPIO's>	28

Appendix D <Programming Watchdog Timer > 29
Contact Information..... 31

Chapter 1 <Introduction>

1.1 <Product Overview>

The LP-173 motherboard is design based on Intel® Celeron® Processor J1900 / N2930 and Intel® Atom Processor E3845, delivering outstanding compute, graphical, and media performance while operating in an extended range of thermal conditions. The SoC bases on the Silvermont microarchitecture, utilizing Intel's industry-leading 22nm process technology with 3-D Tri-Gate transistors, which deliver significant improvements in computational performance and energy efficiency.

New features for Intel® Celeron® and Atom Processor

The Intel® Celeron® Processor J1900 / N2930 and Intel® Atom E3845 Processor supports graphics, media performance, flexibility and more enhanced security that is suitable for a variety of intelligent systems the ideal choice.

Outstanding integration of I/O interfaces

Supports display interfaces with graphics processing, camera interfaces with image processing, audio with digital signal processing, multiple storage types, and legacy embedded I/O. Provides interface expansion capabilities through industry-standard high-bandwidth interfaces such as PCI Express* Gen 2.0, Hi-speed USB 2.0, and USB 3.0 connectivity.

All in One multimedia solution

Based on Intel® J1900 / N2920 /E3845 SoC, the board provides high performance onboard graphics, CRT, 24-bit dual channel LVDS interface, DVI and 2 channels High Definition Audio, to meet the very requirement of the multimedia application.

Flexible Extension Interface

The board provides one PCIe mini slot

1.2 <Product Specification>

General Specification	
Form Factor	PICO-ITX miniboard
CPU	Intel® Processor J1900/N2930/E3845, package type FCBGA1170
Memory	1 x DDR3L (support 1.35V) 1066/1333 SO-DIMM up to 8GB
Watchdog Timer	System reset programmable watchdog timer with 1 ~ 255 sec./min. of timeout value
Real Time Clock	Chipset integrated RTC with onboard lithium battery
Serial ATA	1 x serial ATA interface with 300MB/s(3Gb/s) transfer rate
VGA Interface	Intel® Clear Video integrated HD Graphics Technology
LVDS Interface	1 x Onboard 24-bit dual channel LVDS connector with +3.3V/+5V supply
Audio Interface	Realtek ALC262 High Definition Audio Codec
LAN Interface	1 x Intel® I210 Gigabit LAN
GPIO interface	Onboard programmable 8-bit Digital I/O interface.
Extended Interface	1 x PCIE Mini card or mSATA
Internal I/O Port	2 x RS232, 1 x GPIO, 1 x Audio connector, 1 x CRT, 1 x LVDS, 1 x LPC, 2 x USB 2.0(EHCI) and 1 x SATAII
External I/O Port	1 x DVI port, 1 x RJ45 LAN port, 1 x USB 3.0(XHCI)/2.0(EHCI) port, 1 x USB 2.0(EHCI) port.
Power Requirement	6~27V DC Input
Dimension	100mm x 72mm
Temperature	Operating within 0~60 °C (for LP-173J and LP-173N serial) Operating within -40~75 °C (for LP-173E serial)
Ordering Code	
LP-173J	Intel Celeron Processor J1900 (2M Cache, 2.42GHz), DVI, LVDS, CRT, Gigabit LAN, USB3.0 & 2.0, Serial Port, SATAII, Audio, PCIE Mini card or mSATA, GPIO, LPC
LP-173N	Intel Celeron Processor N2930 (2M Cache, 2.16GHz), DVI, LVDS, CRT, Gigabit LAN, USB3.0 & 2.0, Serial Port, SATAII, Audio, PCIE Mini card or mSATA, GPIO, LPC
LP-173E	Intel Atom Processor E3845 (2M Cache, 1.91GHz), DVI, LVDS, CRT, Gigabit LAN, USB3.0 & 2.0, Serial Port, SATAII, Audio, PCIE Mini card or mSATA, GPIO, LPC

The specifications may be different as the actual production.

For further product information please visit the website at

TU<http://www.commell.com.tw>

1.3 <Mechanical Drawing>

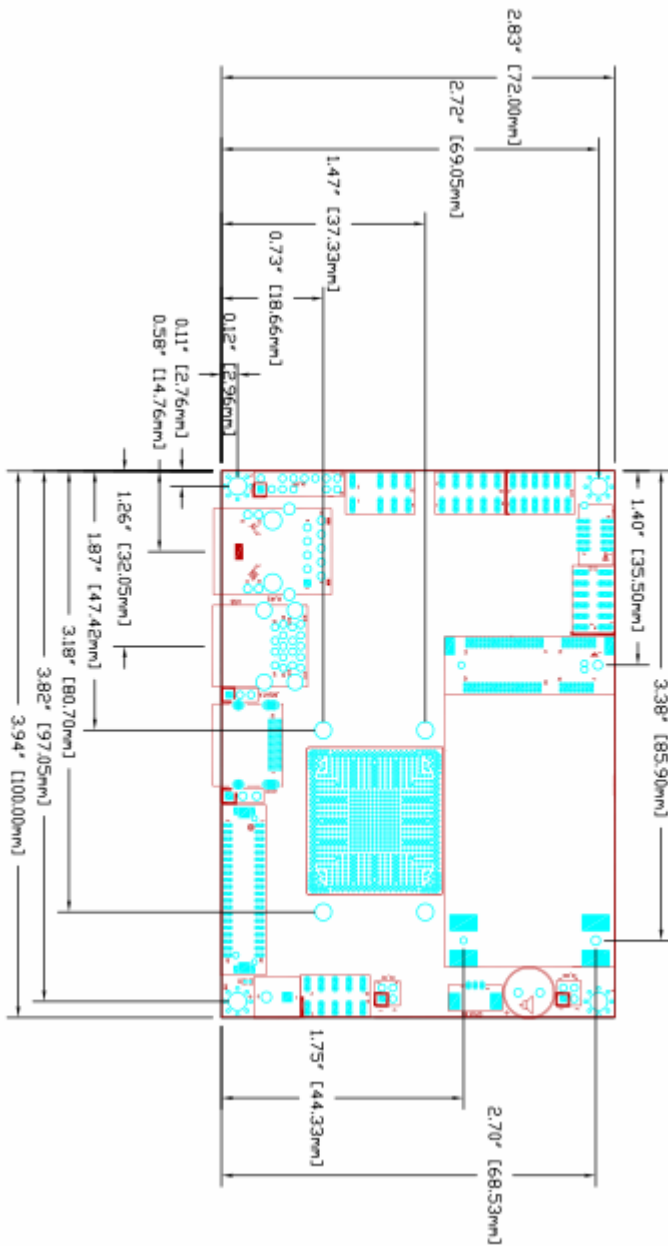

1.4 <Block Diagram>

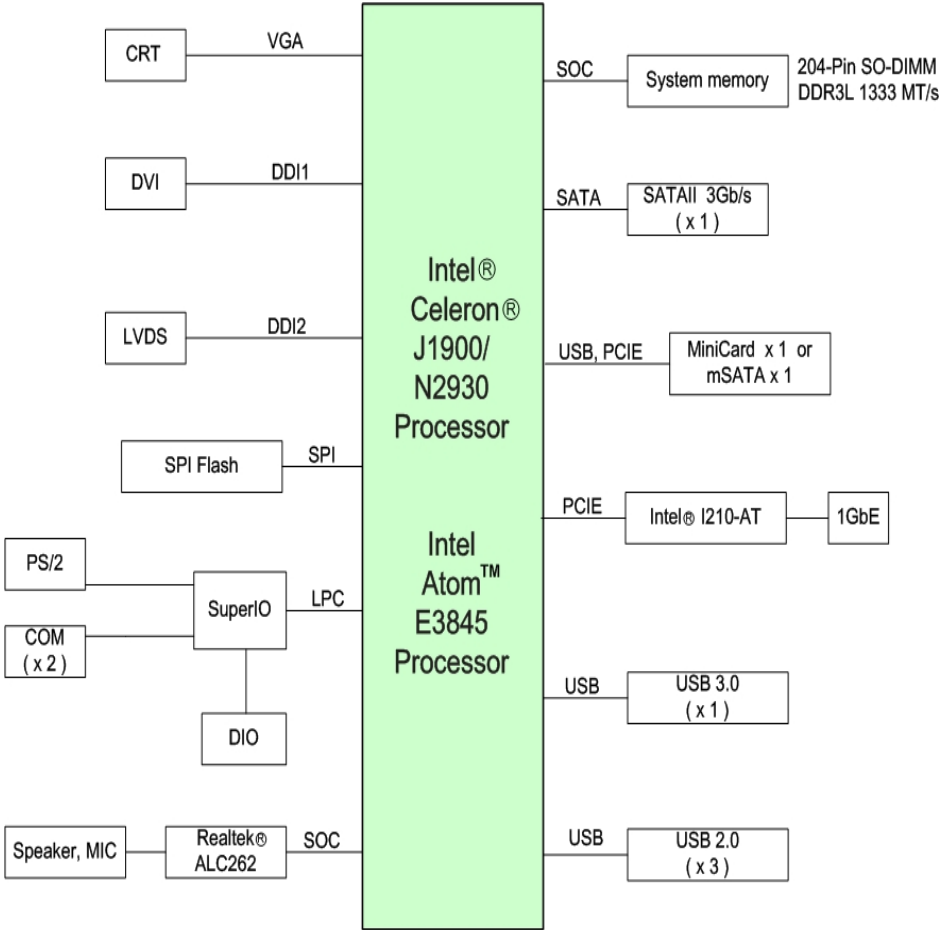

Chapter 2 <Hardware Setup>

2.1 <Connector Location>

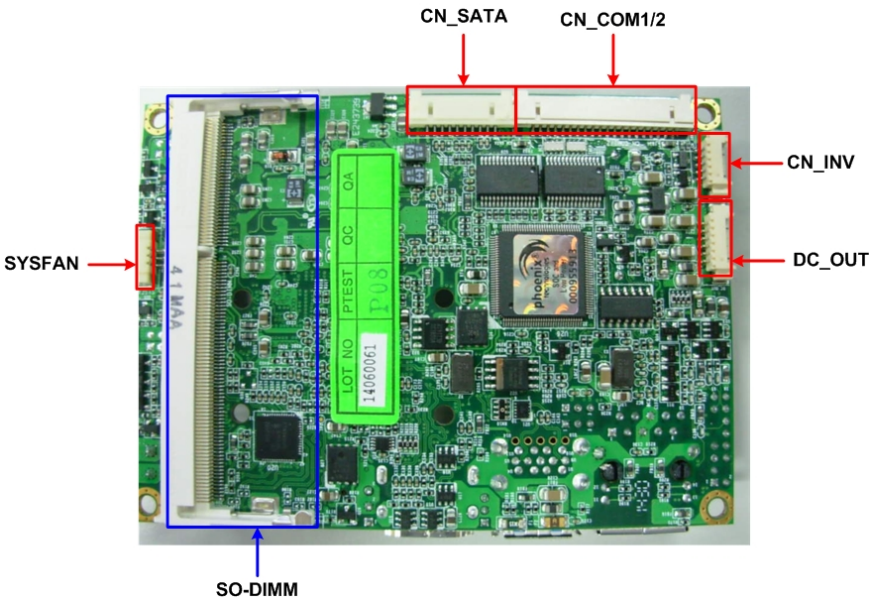
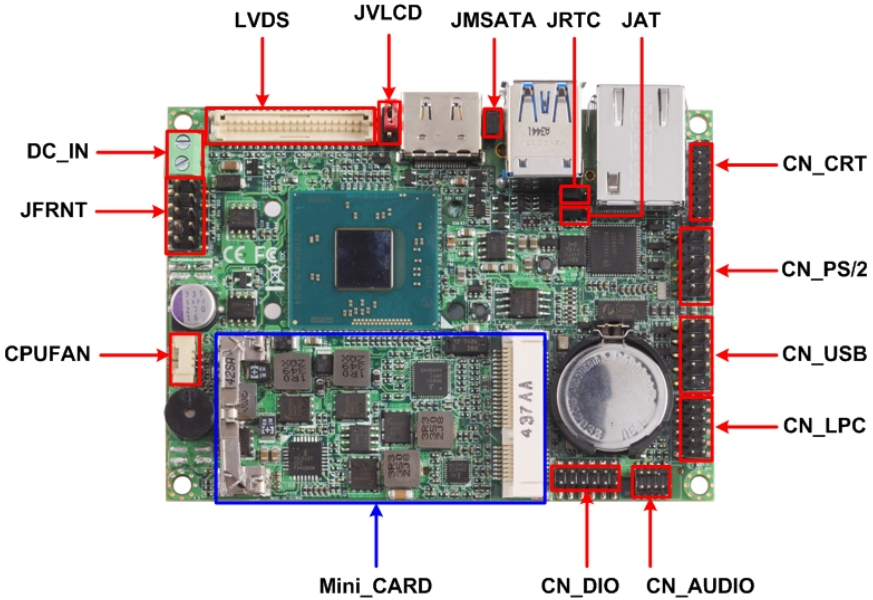

2.2 <Jumper Reference>

Jumper	Function
JRTC	CMOS Operating/Clear Setting
JAT	AT/ATX Mode Setting
JVLCD	LCD Panel Voltage Setting
JMSATA	Mini Card1 mSATA Setting

2.3 <Connector Reference>

2.3.1 <Internal Connector>

Connector	Function	Remark
SO-DIMM	204 -pin DDR3L SO-DIMM SDRAM slot	
CN_SATA	10-pin SATA Cable connector	
MINI_CARD	PCIe mini card socket	
CN_INV	5-pin LCD inverter connector	
CN_USB1/2	5 x 2-pin USB connector	
CN_AUDIO	5 x 2-pin audio connector	
CN_LPC	5 x 2-pin header for LPC Port	
CN_COM1/2	10 x 2-pin com connector	
JFRNT	10-pin switch/indicator connector	
CPUFAN	3-pin CPU cooler fan connector	
SYSFAN	3-pin system cooler fan connector	
DC_OUT	6-pin power output connector	
DC_IN	DC input connector	

2.3.2 <External Connector>

Connector	Function	Remark
DVI	19-pin HDMI connector	
USB 1/2	USB 2.0 and USB 3.0 connector	
RJ45	RJ45 LAN connector	

2.4 <Memory Setup>

The board provide 204-pin DDR3L SO-DIMM to support 1066/1333MHz up to 8GB. Support Non-ECC, unbuffered memory only

2.5 <CMOS & ATX Setup>

The board's data of CMOS can be setting in BIOS. If the board refuses to boot due to inappropriate CMOS settings, please remove battery to clear (reset) the CMOS to its default values.

Jumper: **JAT**

Type: onboard 3-pin jumper

JAT	Mode
1-2	AT Mode
2-3	ATX Mode

Default setting

Jumper: **JRTC**

Type: onboard 3-pin jumper

JRTC	Mode
1-2	Clear CMOS
2-3	Normal Operation

Default setting

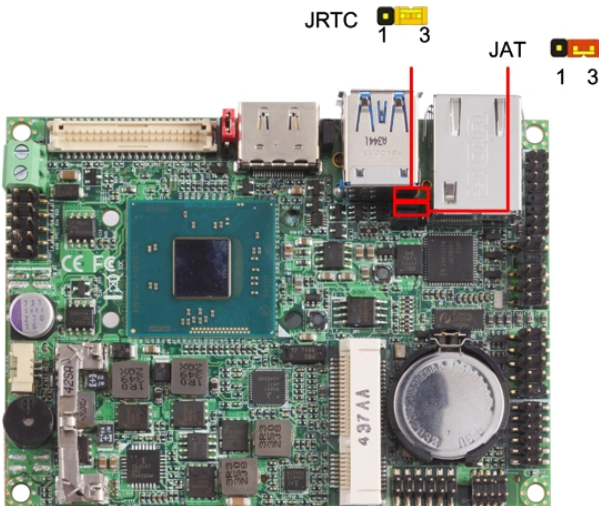

2.6 <SATA Interface>

Based on SOC, the board provides one Serial ATAII interfaces with up to 300MB/s of transfer rate.

2.7 <LAN Interface>

The board integrates with one Intel® I210-AT controller, The Intel Gigabit Ethernet supports triple speed of 10/100/1000Base-T, with IEEE802.3 compliance.

2.8 <Onboard Display Interface>

Based on Intel Processor with built-in I HD Graphic, the board provides one DVI connector on real external I/O port, and LVDS interface with 5-pin LCD backlight inverter connector. The board provides dual display function with clone mode and extended desktop mode for CRT, DVI and LVDS.

2.8.1 <Analog VGA Interface>

Please connect your CRT or LCD monitor to the onboard CRT connector .

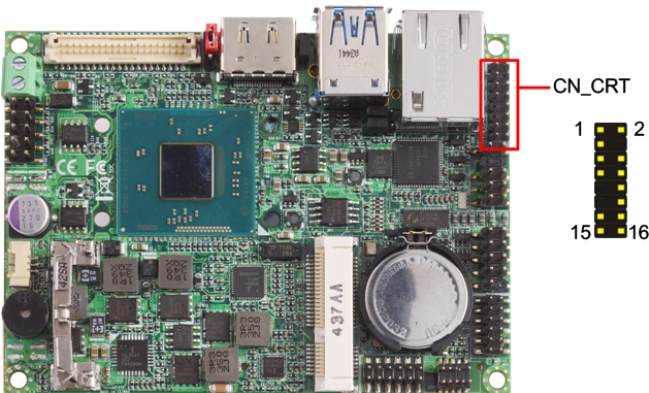

Connector: **CN_CRT**

Type: onboard 16-pin connector for CN_CRT connector pitch 2.00mm

Pin	Signal	Pin	Signal
1	BR	2	BG
3	BB	4	NC

5	-CRTATCH	6	IOGND1
7	IOGND1	8	IOGND1
9	NC	10	-CRTATCH
11	NC	12	5VCD A
13	5HSYNC	14	5VSYNC
15	5VCLK	16	NC

2.8.2 <CN_LVDS>

The board provides one 20-pin LVDS connector for 18 bit or 24bit single channel panel, with one LCD backlight inverter connector and one jumper for panel voltage setting.

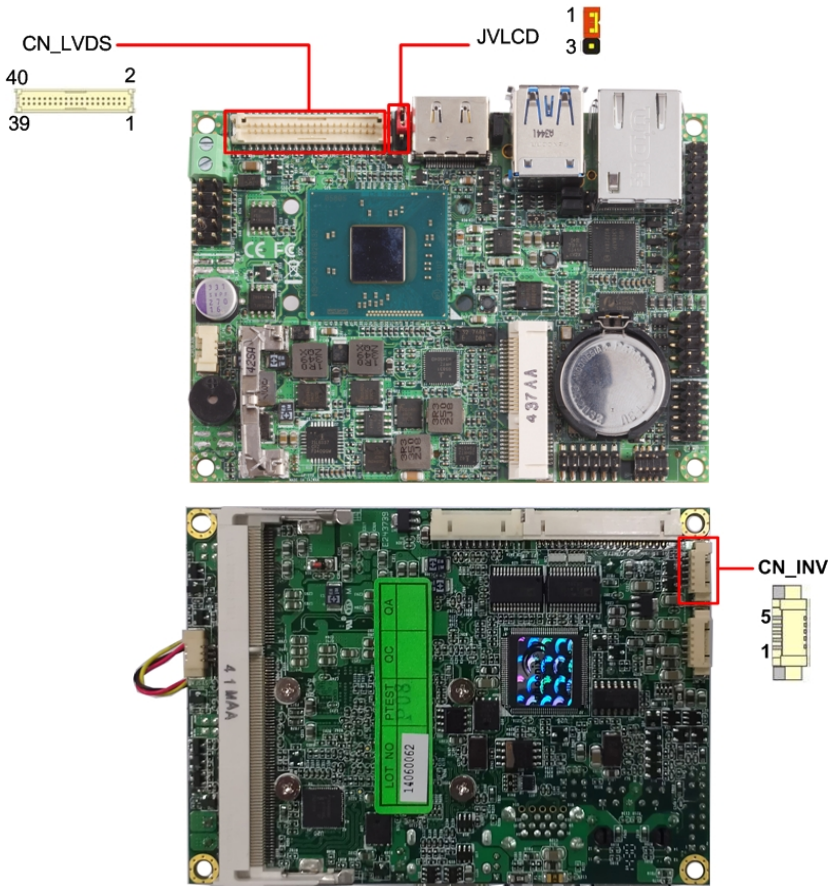

Connector: **CN_INV**

Type: 5-pin Inverter power connector

Connector model: **molex_53261-5pin** or compatible

Pin	Description
1	+12V
2	CTLBKL
3	+5V
4	GND
5	Enable

Jumper: **JVLCD**

Type: 3-pin Power select jumper

Pin	Description
1-2	+3.3V
2-3	+5V

Default setting

Connector: **CN_LVDS** Type: onboard 20-pin connector for LVDS connector

Type: onboard 40-pin connector for LVDS connector

Connector model: **HIROSE DF13-40DP-1.25V**

Pin	Signal	Pin	Signal
2	LCDVCC	1	LCDVCC
4	GND	3	GND
6	ATX0-	5	BTX0-
8	ATX0+	7	BTX0+
10	GND	9	GND
12	ATX1-	11	BTX1-
14	ATX1+	13	BTX1+
16	GND	15	GND
18	ATX2-	17	BTX2-
20	ATX2+	19	BTX2+
22	GND	21	GND
24	ACLK-	23	BTX3-
26	ACLK+	25	BTX3+
28	GND	27	GND
30	ATX3-	29	BCLK-
32	ATX3+	31	BCLK+
34	GND	33	GND
36	DDCPCLK	35	SMBCKL
38	DDCPDATA	37	SMBDATA
40	N/C	39	SPDIFO

To setup the LCD, you need the component below:

1. A panel with LVDS interfaces.

2. An inverter for panel's backlight power.
3. A LCD cable and an inverter cable.

For the cables, please follow the pin assignment of the connector to make a cable, because every panel has its own pin assignment, so we do not provide a standard cable; please find a local cable manufacture to make cables.

LCD Installation Guide:

1. Preparing the LP-173, LCD panel and the backlight inverter



2. You would need a LVDS type cable.



3. To connect all of the devices well.

After setup the devices well, you need to select the LCD panel type in the BIOS.

The panel type mapping is list below:

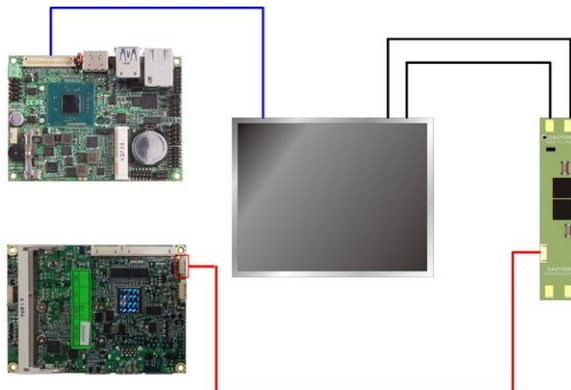

BIOS panel type selection form (BIOS Version:1.0)			
Single / Dual channel		Single / Dual channel	
NO.	Output format	NO.	Output format
1	640 x 480	9	1680 x 1050
2	800 x 600	10	1920 x 1200
3	1024 x 768	11	1440 x 900
4	1280 x 1024	12	1600 x 900
5	1400 x 1050	13	1024 x 768
6	1400 x 1050	14	1280 x 800
7	1600 x 1200	15	1920 x 1080
8	1366 x 768		

2.9 <Onboard Audio Interface>

The board provides the onboard high definition audio with Realtek ALC262

Connector: CN_AUDIO

Type: 10-pin (2 x 5) 1.27mm x 2.54mm-pitch header

Pin	Description	Pin	Description
1	MIC2_L	2	AGND
3	MIC2_R	4	AVCC
5	FP_OUT_R	6	MIC2_JD
7	SENSE_B	8	N/C
9	FP_OUT_L	10	LINE2_JD

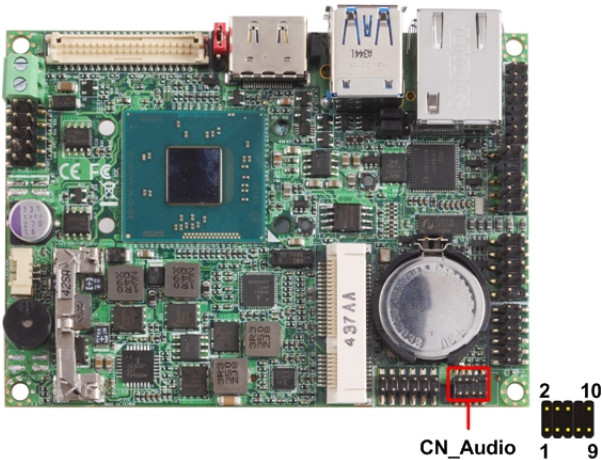

2.10 <USB 3.0 and USB 2.0Interface>

LP-173 integrates 1 x USB3.0 and 3 x USB2.0, The specifications are listed below:

Interface	USB3.0	USB2.0
Transfer Rate	Up to 5Gb/s	Up to 480Mb/s
Voltage	5V	5V

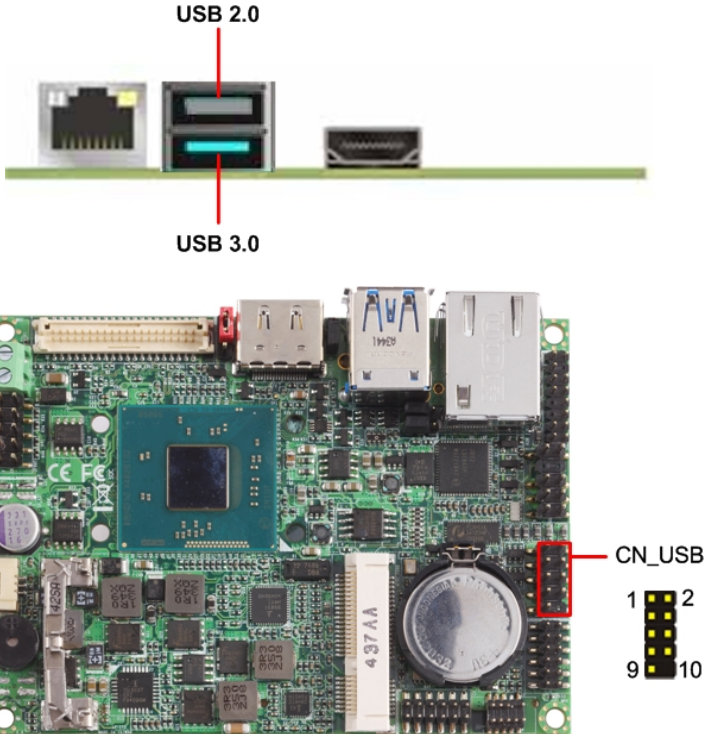

Connector: **CN_USB**

Type: 10-pin (5 x 2) header for USB Port **(USB2.0)**

Pin	Description	Pin	Description
1	VCC	2	VCC
3	Data0-	4	Data1-
5	Data0+	6	Data1+
7	Ground	8	Ground
9	Ground	10	N/C

The USB3.0 port need to Install USB 3.0 eXtensible Host Controller Driver and

enable xHCI Mode.

USB 3.0 eXtensible Host Controller Driver install

- Step1.** Copy the USB 3.0 driver from “Driver CD” to the local hard driver directory,
- Step2.** Configure default BIOS, click Advanced > South Cluster Configuration > USB Configuration, disable “EHCI Mode”.

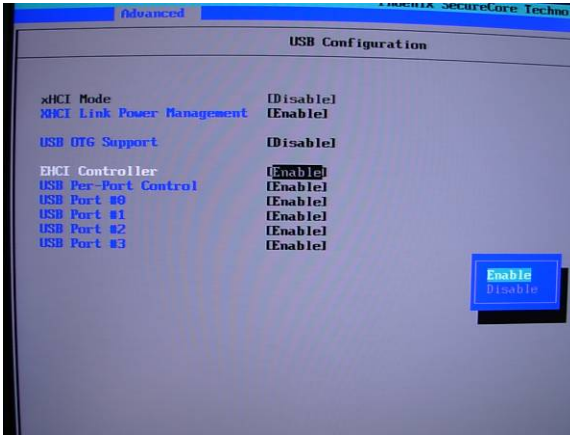

- Step3.** enable “xHCI Mode” and push “F10” to save configuration. Restart your computer.

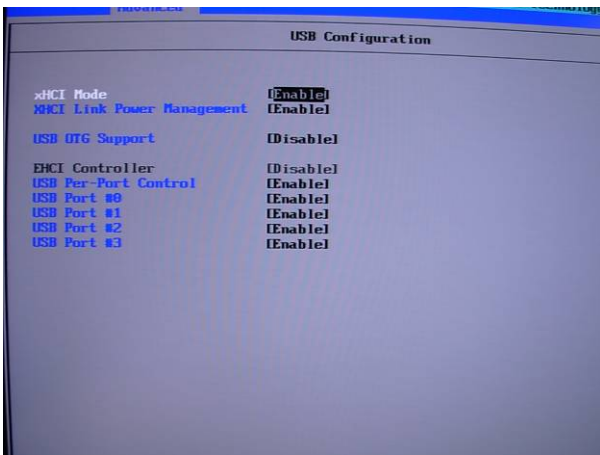

- Step4.** If you enable xHCI Mode , USB 2.0 and USB 3.0 ports can't use without drive. We recommend that you connect PS/2 mouse / keyboard installing

USB 3.0 driver.

Step5. Double click the “Setup.exe” from the directory. Click “Next” to continue.

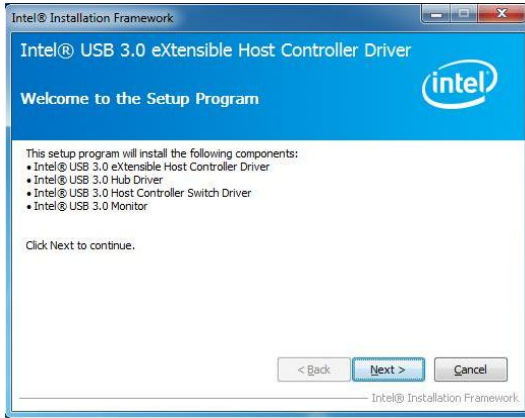

Step6. Lastly, the “Setup Complete” screen appears so click “Finish” to restart your computer.



2.11 <Serial Port Jumper Setting >

The board provides two RS232 serial ports

Connector: **CN_COM1/2**

Type: 20-pin (5 x 2) 1.27mm x 2.54mm-pitch header for COM1/2

Pin	Description	Pin	Description
1	MDCD1-	2	MSIN1-

3	MSO1-	4	MDTR1-
5	N/C	6	MDSR1-
7	MRTS1-	8	MCTS1-
9	MRI1-	10	N/C
11	MDCD2-	12	MSIN2-
13	MSO2-	14	MDTR2-
15	GND	16	MDSR2-
17	MRTS2-	18	MCTS2-
19	MRI2-	20	N/C

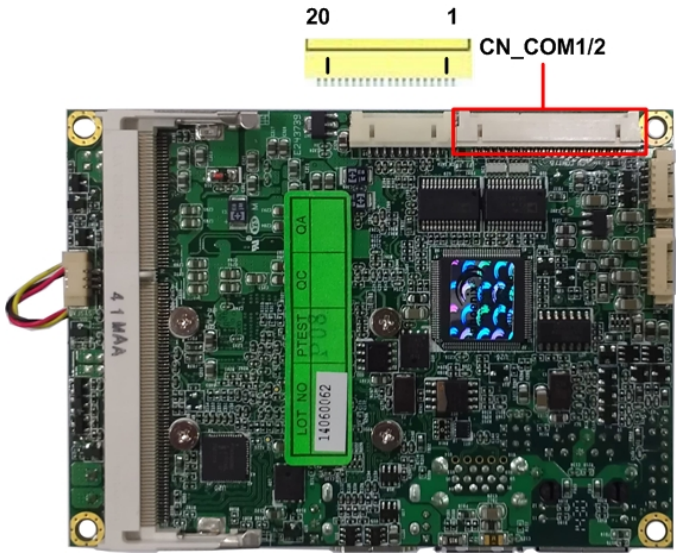

2.12 <Power & FAN Connector >

The board requires DC input with 2-pin header, the input voltage range is from 5V for the input current, please take a reference of the power consumption report on appendix.

2.12.1 <Power Input>

Connector: DC_IN

Type: 2-pin header

Pin	Description	Pin	Description
1	Ground	2	+6V ~ +27V

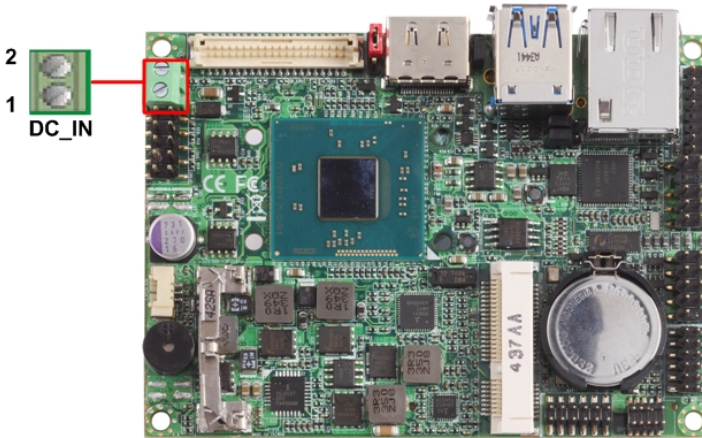

2.12.2 <Power Output>

Connector: **DC_OUT**

Type: 6-pin connector for **+12V** and **+5V**

Pin	Description	Pin	Description	Pin	Description
1	+12V	2	+12V	3	Ground
4	Ground	5	+5V	6	+5V



2.12.3 <Fan Connector>

Connector: **SYSFAN**

Type: 3-pin fan wafer connector

Pin	Description	Pin	Description	Pin	Description
1	Ground	2	+12V	3	SYSFAN

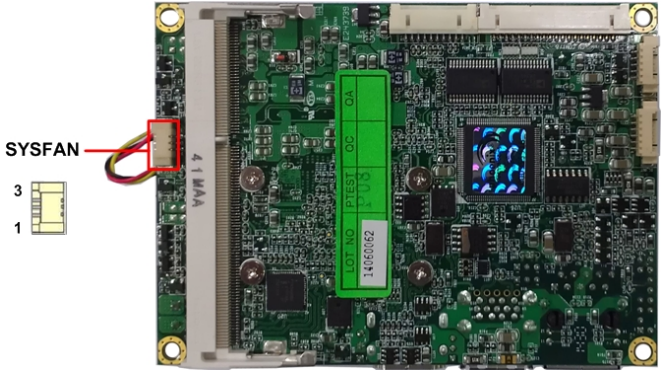

Connector: **CPUFAN**
 Type: 3-pin fan wafer connector

Pin	Description	Pin	Description	Pin	Description
1	Ground	2	+12V	3	CPUFAN

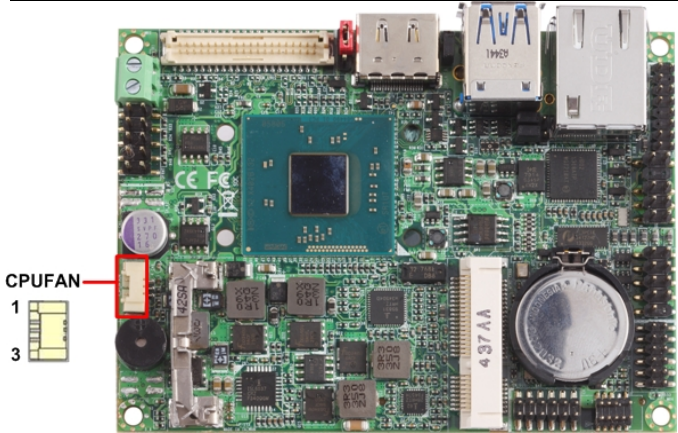

2.13 <Indicator and Switch>

The **JFRNT** provides front control panel of the board, such as power button, reset and beeper, etc. Please check well before you connecting the cables on the chassis.

Connector: **JFRNT**
 Type: onboard 10-pin (2 x 5) 2.54-pitch header

Function	Signal	PIN		Signal
Power	PWRBT-	1	2	PWRBT+
Speaker	SPK-	3	4	SPK+
HDD LED	HLED-	5	6	HLED+
Power LED	GND	7	8	PWLED+
Reset	Reset-	9	10	GND

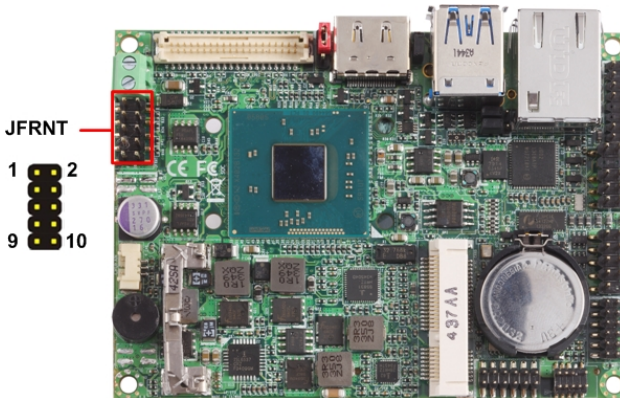

2.14 < PCIE Mini Card >

The board provides one PCIE mini card socket

Jumper: **JMSATA**

Type: onboard 3-pin header

MINI_CARD Mode	JMSATA
Supply mSATA	1-2
MINI_CARD	2-3

Default setting

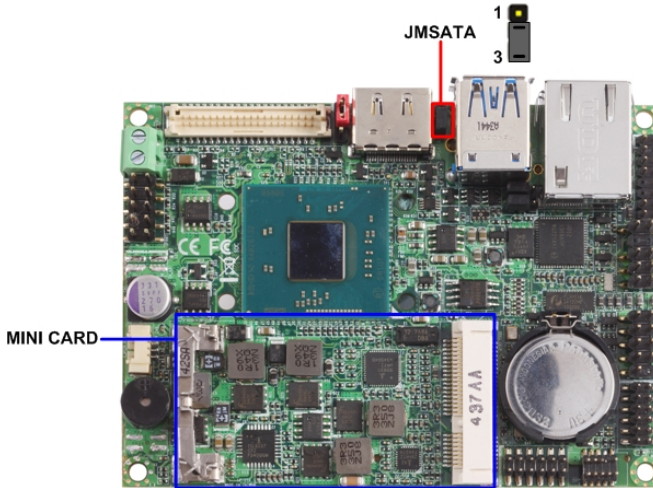

Chapter 3 <BIOS Setup>

The motherboard uses the Phoenix BIOS for the system configuration. The Phoenix BIOS in the single board computer is a customized version of the industrial standard BIOS for IBM PC AT-compatible computers. It supports Intel® x86 and compatible CPU architecture based processors and computers. The BIOS provides critical low-level support for the system central processing, memory and I/O sub-systems.

The BIOS setup program of the single board computer let the customers modify the basic configuration setting. The settings are stored in a dedicated battery-backed memory, NVRAM, retains the information when the power is turned off. If the battery runs out of the power, then the settings of BIOS will come back to the default setting.

The BIOS section of the manual is subject to change without notice and is provided here for reference purpose only. The settings and configurations of the BIOS are current at the time of print, and therefore they may not be exactly the same as that displayed on your screen.

To activate CMOS Setup program, press key immediately after you turn on the system. The following message “Press DEL to enter SETUP” should appear in the lower left hand corner of your screen. When you enter the CMOS Setup Utility, the Main Menu will be displayed as **Figure** You can use arrow keys to select your function, press <Enter> key to accept the selection and enter the sub-menu.

Figure CMOS Setup Utility Main Screen



Appendix A <I/O Port Pin Assignment>

A.1 <SATA Port>

Connector: **SATA**

Type: 10-pin header for SATA Port

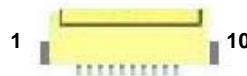

Pin	Description	Pin	Description
1	Ground	2	TXP
3	TXN	4	Ground
5	N/C	6	N/C
7	Ground	8	RXN
9	RXP	10	Ground

A.2 <LAN Port>

Connector: **RJ45**

Type: RJ45 connector with LED on rear panel

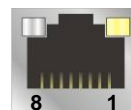

Pin	1	2	3	4	5	6	7	8
Description	TRD0+	TRD0-	TRD1+	TRD2+	TRD2-	TRD1-	TRD3+	TRD3-

A.3 <LPC Port>

Connector: **CN_LPC**

Type: 10-pin header for LPC Port

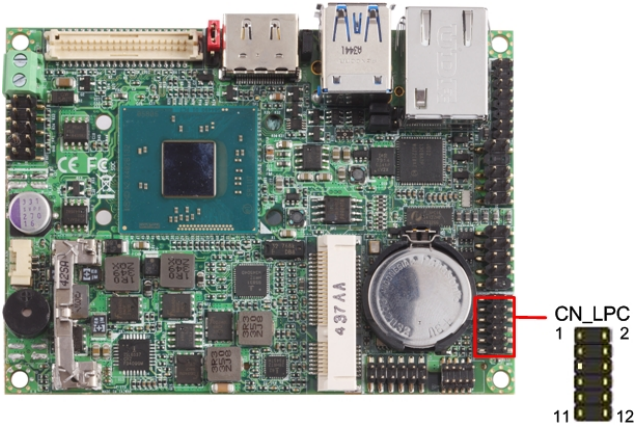

Pin	Description	Pin	Description
1	LPC_CLK	2	RESET-
3	LFRAME-	4	LAD3
5	LAD2	6	LAD1
7	LAD0	8	+3.3V
9	Ground	10	Ground

A.4 <GPIO Port>

Connector: **CN_DIO**

Type: 12-pin (6 x 2) header (pitch = 2.0mm)

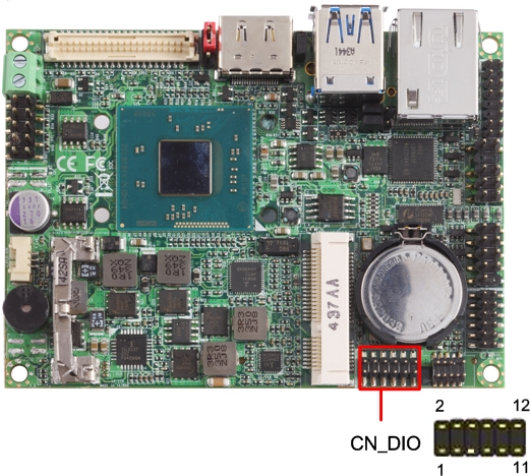

Pin	Description	Pin	Description
1	Ground	2	Ground
3	GP10	4	GP14
5	GP11	6	GP15
7	GP12	8	GP16
9	GP13	10	GP17
11	5V	12	12V

Appendix B <Flash BIOS>

B.1 BIOS Auto Flash Tool

The board is based on Phoenix BIOS and can be updated easily by the BIOS auto flash tool. You can download the tool online at the address below:

<http://www.phoenix.com/en/home/>

http://www.commell.com.tw/Support/Support_SBC.htm

B.2 Flash Method

- 1.Extract the zip file(re-flash tool and BIOS file) to root of the USB flash drive.
- 2.Insert your USB flash drive in USB port of the board and power on the system.
3. Boot to EFI-Shell mode (**UEFI Boot Enable, Legacy Boot Disable**)

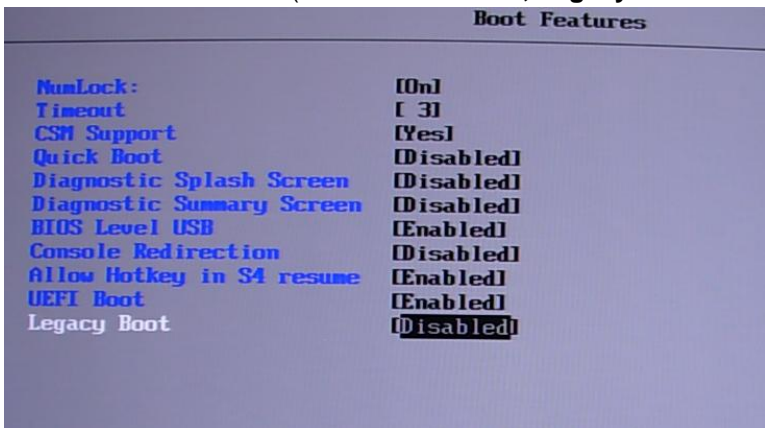

then input the “fs0:” command to switch to the root of the USB flash drive.

```

Device mapping table
fs0 :Removable HardDisk - Alias hd31a0d0b blk0
      Acpi (PNP0A03,0)/Pci (1D10)/Usb (0,0)/Usb (3,0)/HD (Part1,Sig0001624F)
blk0 :Removable HardDisk - Alias hd31a0d0b fs0
      Acpi (PNP0A03,0)/Pci (1D10)/Usb (0,0)/Usb (3,0)/HD (Part1,Sig0001624F)
blk1 :HardDisk - Alias (null)
      Acpi (PNP0A03,0)/Pci (1310)/Sata (0,0,0)/HD (Part1,SigD002A069)
blk2 :HardDisk - Alias (null)
      Acpi (PNP0A03,0)/Pci (1310)/Sata (0,0,0)/HD (Part2,SigD002A069)
blk3 :HardDisk - Alias (null)
      Acpi (PNP0A03,0)/Pci (1310)/Sata (0,0,0)/HD (Part3,SigD002A069)
blk4 :BlockDevice - Alias (null)
      Acpi (PNP0A03,0)/Pci (1310)/Sata (0,0,0)
blk5 :Removable BlockDevice - Alias (null)
      Acpi (PNP0A03,0)/Pci (1D10)/Usb (0,0)/Usb (3,0)

Press ESC in 1 seconds to skip startup.nsh, any other key to continue.
hell> fs0:

```

4. Type the " **fpt64.efi -y -f xxx.bin**" command to start flash BIOS processes. (xxx.bin means the BIOS file that you want to update)
5. When it finished all update processes, restart the system.

Any question about the BIOS re-flash please contact your distributors or visit the web-site at below:

<http://www.comnell.com.tw/support/support.htm>

Appendix C <Programming GPIO's>

The GPIO' can be programmed with the MSDOS debug program using simple IN/OUT commands. The following lines show an example how to do this. (The GPIO is **open drain**)

```

GPIO0.....GPIO7  bit0.....bit7
-o 4E 87           ;enter configuration
-o 4E 87
-o 4E 07
-o 4F 07           ;enale GPIO function
-o 4E 30
-o 4F 10           ;enable GPIO configuration
-o 4E F0

```

- o 4F xx ;set GPIO as input/output; set '1' for input,'0'for output
- o 4E F1
- o 4F xx ;if set GPIO's as output,in this register its value can be set

Optional :

- o 4E F2
- o 4F xx ; Data inversion register ; '1' inverts the current valus of the bits , '0' leaves them as they are
- o 4E 30
- o 4F 01 ; active GPIO's

For further information, please refer to NCT6106D datasheet.

Appendix D <Programming Watchdog Timer >

The watchdog timer makes the system auto-reset while it stops to work for a period.

The integrated watchdog timer can be setup as system reset mode by program.

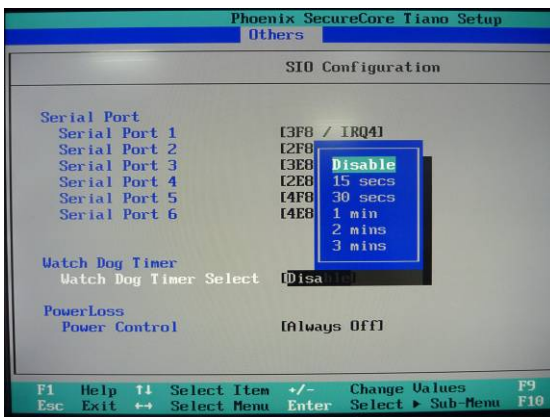

Timeout Value Range

- 1 to 255

- Second or Minute

Program Sample

The integrated Watchdog Timer can be set up by programming.

-O 4E 87 Enter configuration

-O 4E 87

-O 4E 07 Logic Device Enable

-O 4F 08

-O 4E 30 WDT Enable

-O 4F 01

-O 4E F0 Set as Second*

-O 4F 00

-O 4E F1

-O 4F 0A Set reset time 10 Sec

You can select Timer setting in the BIOS, after setting the time options, the system will reset according to the period of your selection.

Contact Information

Any advice or comment about our products and service, or anything we can help you please don't hesitate to contact with us. We will do our best to support you for your products, projects and business.

Taiwan Commate Computer Inc.

Address	19F., No.94, Sec. 1, Xintai 5 th Rd., Xizhi Dist., New Taipei City 22102, Taiwan
TEL	+886-2-26963909
FAX	+886-2-26963911
Website	http://www.commell.com.tw
E-Mail	info@commell.com.tw (General Information) tech@commell.com.tw (Technical Support)
Facebook	https://www.facebook.com/pages/Taiwan-Commate-Computer-Inc/547993955271899

Commell is our trademark of industrial PC division