

LP-175

Pico-ITX Motherboard

User's Manual

Edition 1.0
2016/09/07

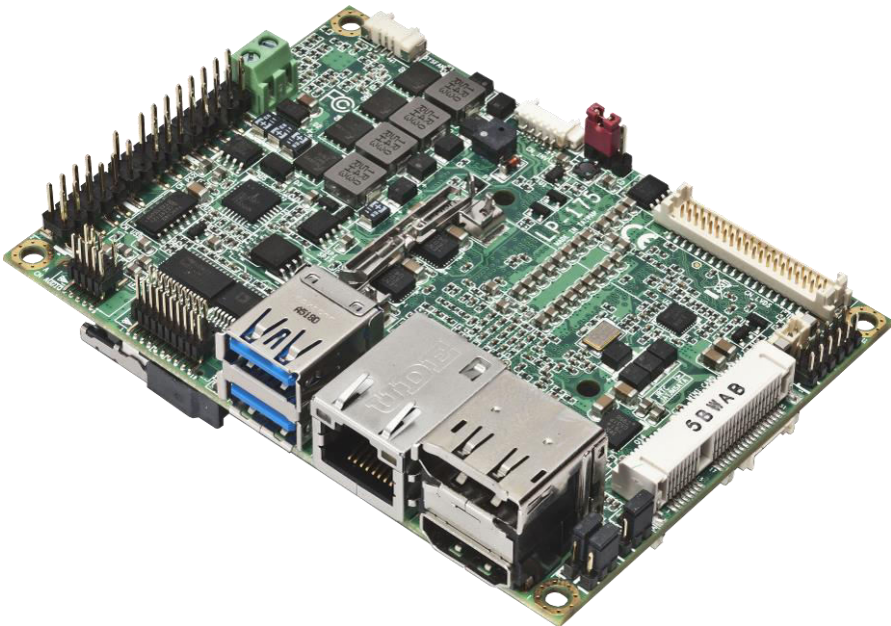

Copyright

Copyright 2016, all rights reserved. This document is copyrighted and all rights are reserved. The information in this document is subject to change without prior notice to make improvements to the products.

This document contains proprietary information and protected by copyright. No part of this document may be reproduced, copied, or translated in any form or any means without prior written permission of the manufacturer.

All trademarks and/or registered trademarks contains in this document are property of their respective owners.

Disclaimer

The company shall not be liable for any incidental or consequential damages resulting from the performance or use of this product.

The company does not issue a warranty of any kind, express or implied, including without limitation implied warranties of merchantability or fitness for a particular purpose.

The company has the right to revise the manual or include changes in the specifications of the product described within it at any time without notice and without obligation to notify any person of such revision or changes.

Trademark

All trademarks are the property of their respective holders.

Any questions please visit our website at <http://www.commell.com.tw>

Packing List:

Please check the package content before you starting using the board.



1 x LP-175 Pico-ITX Motherboard
(include Heat Spreader)



1 x SATA & SATA Power Cable
(OALSATA22B-PM15SH15 / 1040512)



1 x PS/2 Keyboard & Mouse cable
(OALPS2/KM / 1040131)



1 xDC Input Power Cable
(OALDC-B / 1040513)



1 x Audio cable
(OALPJ-HDUNB / 1040123)

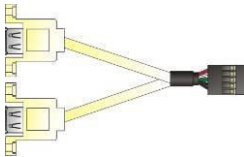

1 xUSB2.0 Cable
(OALUSBA-3 / 1040173)

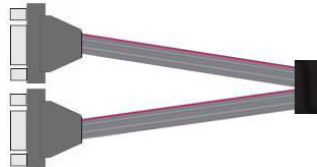

1 x Dual COM Cable
(OALES-BKU2NB / 1040090)

Printed Matters:

Driver CD x 1 (Including User's Manual)

Index

Chapter 1 <Introduction>	4
1.1 <Product Overview>	4
1.2 <Product Specification>	5
1.3 <Mechanical Drawing>	6
1.4 <Block Diagram>	10
Chapter 2 <Hardware setup>	11
2.1 <Connector Location and Reference>	11
2.1.1 <Internal connectors list>	12
2.1.2 <External connectors list>	12
2.2 <Jumper Location and Reference>	13
2.2.1 <Jumper list>	13
2.2.2 <Clear CMOS and Power on type selection>	13
2.3 <Installing the Memory>	14
2.4 <I/O interface>	15
2.4.1 <Serial ATA interface>	15
2.4.2 <Ethernet interface>	15
2.4.3 <Display interface>	16
2.4.4 <Serial Port interface>	18
2.4.5 <USB interface>	18
2.4.6 <Audio interface>	19
2.4.7 <Expansion slot>	20
2.4.8 <Front panel switch and indicator>	20
2.4.9 <Other interface>	21
2.5 <Power supply>	22
2.5.1 <Power input>	22
2.5.2 <Power output>	22
Appendix A <Flash BIOS>	23
Appendix B <Win7 Installation Notes>	24
Appendix C <LCD Panel Type select>	25
Appendix D <Programmable Watch Dog Timer>	26
Contact information	27

Chapter 1 <Introduction>

1.1 <Product Overview>

LV-175 is Pico-ITX Motherboard which supports 6th Generation Intel® Core™ U-series i7, i5, i3, Celeron Mobile Processor with Sunrise Point PCH-LP, integrated HD Graphics, DDR4 memory, Realtek High Definition Audio, Intel Gigabit LAN, Serial ATA3 with AHCI function for a system.

Intel Skylake-U Processor with Sunrise Point PCH-LP

The 6th Generation Intel® Core™ U-series processor family is the next generation, multi-core mobile processor built on 14 nanometer process with MCP technology.

The Skylake-U has a lower TDP 15W and 28W, it provides new HD Graphics (GT2 and GT3 GPU) support triple display at the same time, maximum supported is up to 32GB of DDR4 and DDR3L, better performance, flexibility and more enhanced security that is suitable for a variety of intelligent systems the ideal choice.

All in One multimedia solution

The board provides high performance onboard graphics, 24-bit dual channel LVDS interface, DisplayPort and VGA choosable, HDMI, and High Definition Audio, to meet the very requirement of the multimedia application.

Flexible Expansion Interface

The board provides one MiniPCIe and support mSATA.

1.2 <Product Specification>

System

Processor	Intel® Skylake Core™ i7, i5, i3, Celeron U-series Processor FCBGA1356 with MCP
Chipset	Sunrise Point-LP
Memory	1 x DDR4 SO-DIMM 1866/2133 MHz up to 16GB Support Non-ECC memory
Watchdog Timer	Generates a system reset with internal timer for 1min/s ~ 255min/s
Real Time Clock	Chipset integrated RTC with onboard lithium battery
Expansion	1 x MiniPCIe (support mSATA)

Graphics

Chipset	Intel® 6th Gen integrated HD Graphics
Display Interface	1 x HDMI, 1 x DisplayPort/VGA, 1 x LVDS

LAN

Chip	1 x Intel® I219-LM Gigabit PHY LAN (Support iAMT11.0)
------	---

I/O

Serial ATA	1 x SATA3
Audio	Realtek ALC262 HD Audio
Internal I/O	1 x SATA3, 2 x RS232, 2 x USB2.0, 1 x LVDS, 1 x LPC, 1 x SMBUS, 1 x LCD inverter, 1 x Audio, 1 x DC Out, 1 x PS/2, 1 x VGA for optional
Rear I/O	1 x DisplayPort for optional, 1 x HDMI, 2 x USB3.0, 1 x LAN

Mechanical & Environmental

Power Requirement	DC 5V
Size	100mm x 72mm (L x W)
Temperature	Operating within 0°C~60°C (32°F~140°F) Storage within -20°C~80°C (-4°F~176°F)
Relative Humidity	10%~90%, non-condensing

Note1: If you need to change DisplayPort to VGA, it requires Commell ADP-3355 DP to VGA module, but

LP-175T series not attached ADP-3355 and DisplayPort I/O not retain..

Note1: If you need a wider power input, please refer Commell DC-DC3-5V power module.(input voltage 5~35V)

1.3 <Mechanical Drawing>

Positive

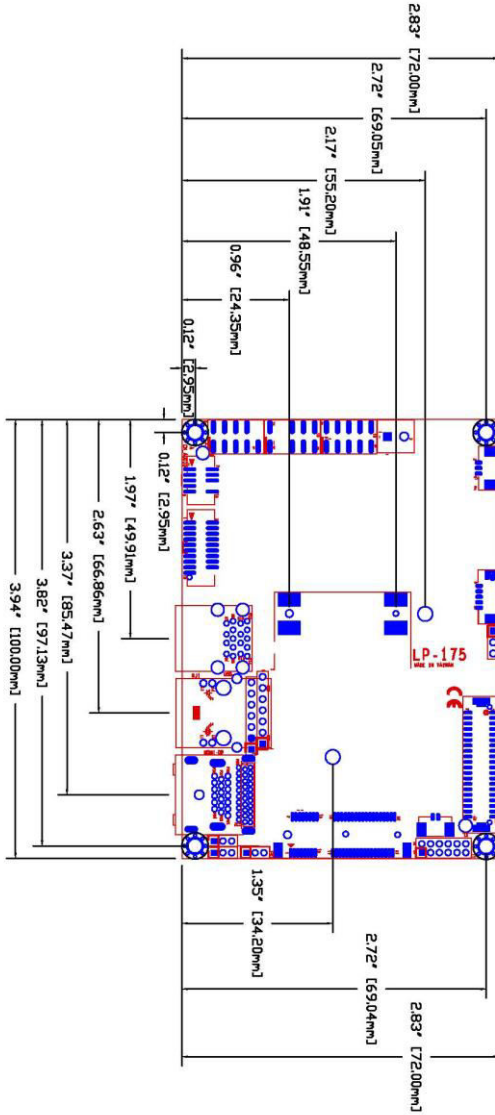

Back

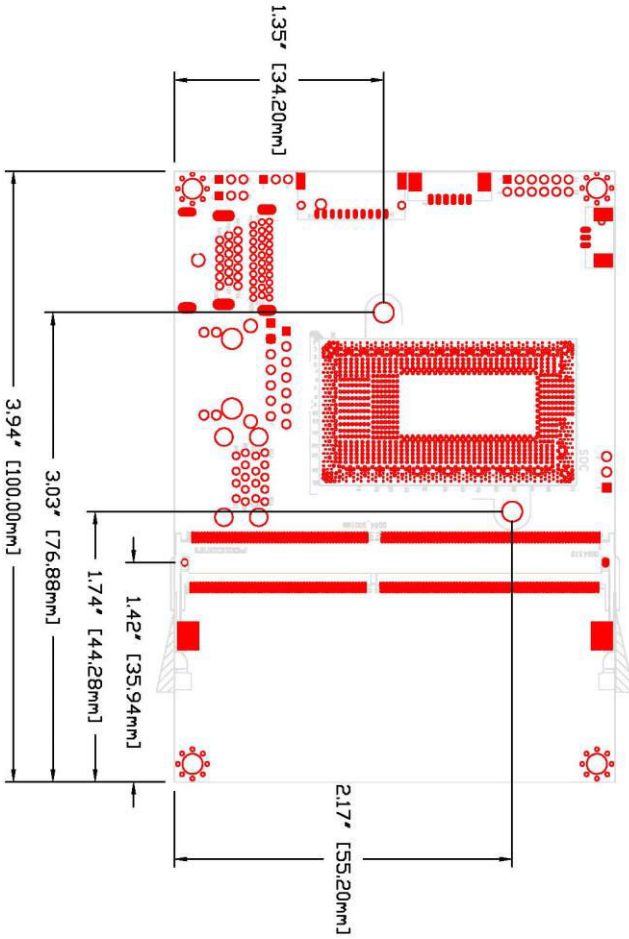

LP-175P

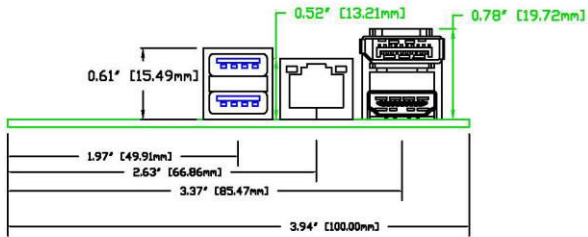

LP-175T

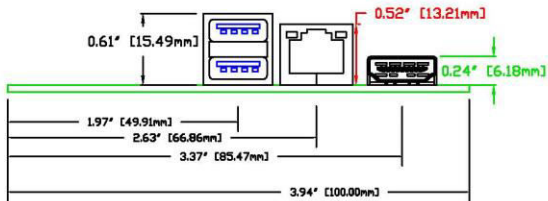

1.4 <Block Diagram>

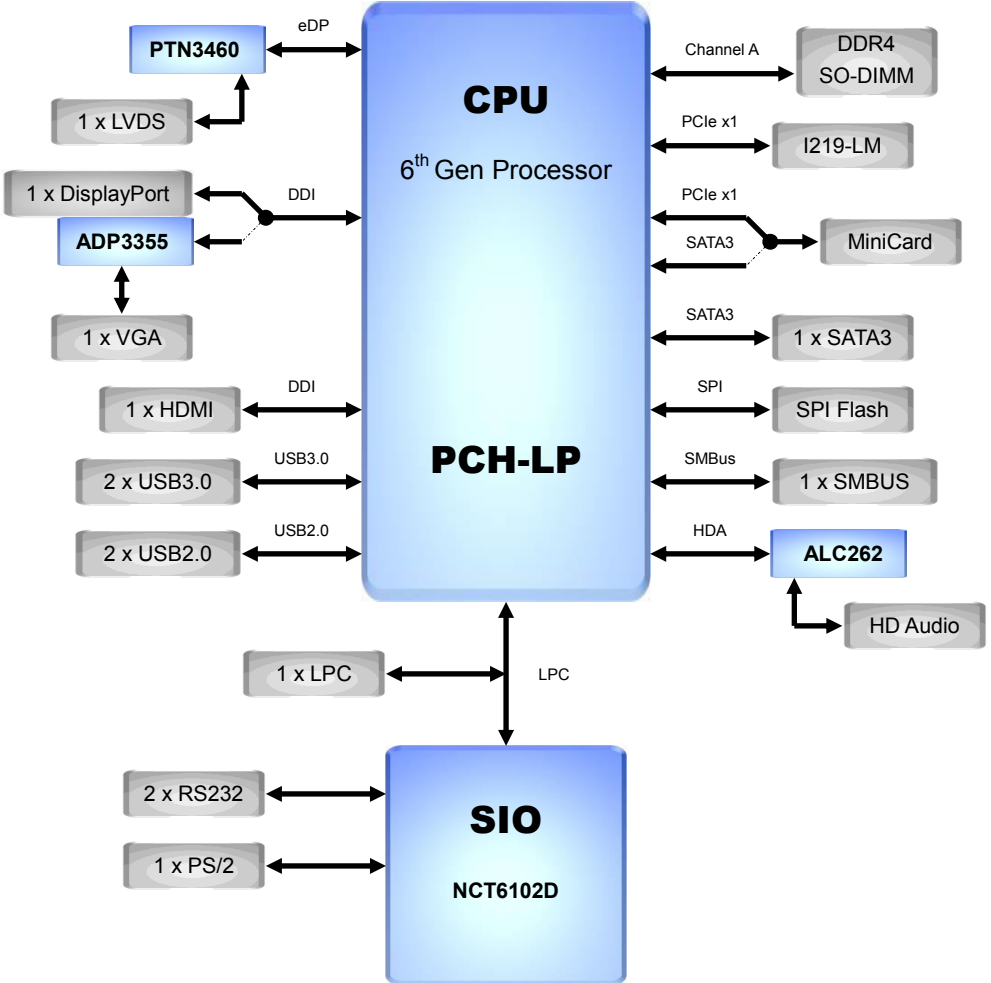

Chapter 2 <Hardware setup>

2.1 <Connector Location and Reference>

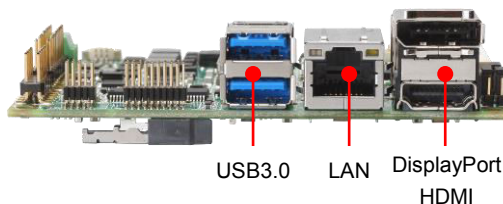
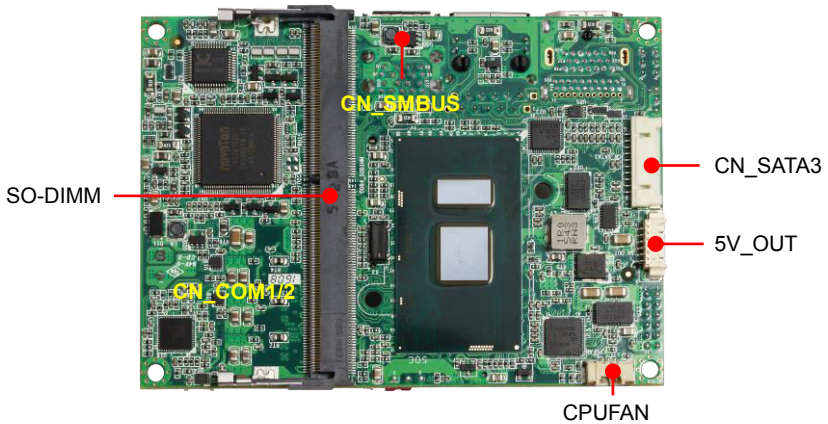
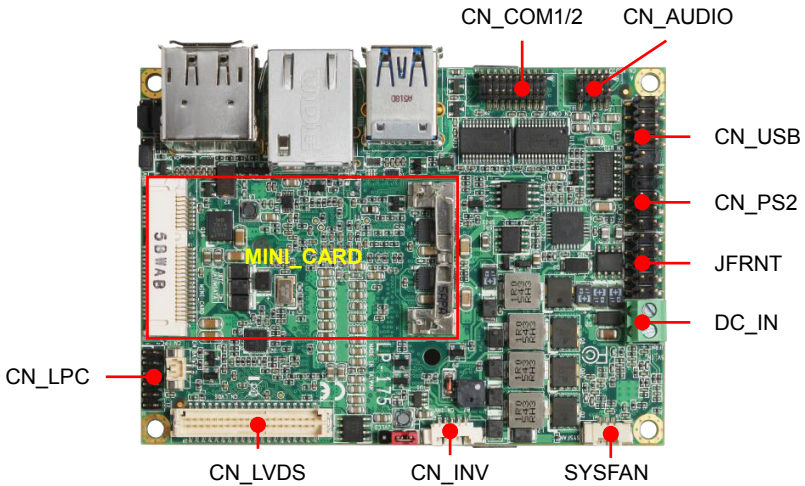

2.1.1 <Internal connectors list>

Connector	Function
SO-DIMM	260-pin DDR4 SO-DIMM slot
CN_SATA3	10-pin Serial ATA3 connector
CN_AUDIO	5 x 2-pin audio pin header
CN_LPC	6 x 2-pin LPC pin header
CN_LVDS	20 x 2-pin LVDS connector
CN_INV	5-pin LCD inverter connector
CN_COM1/2	20-pin RS232 connector
CN_USB	5 x 2-pin USB2.0 pin header
CN_DP	10 x 2-pin DP to VGA module connector
CN_PS2	5 x 2-pin PS/2 pin header
CPUFAN	3-pin CPU fan connector
SYSFAN	3-pin system fan connector
JFRNT	5 x 2-pin front panel switch/indicator pin header
MINI_CARD	52-pin MiniPCIe card slot
5V_OUT	6-pin 5V SATA Power connector
DC_IN	2-pin power input Terminal Block

2.1.2 <External connectors list>

Connector	Function
HDMI	HDMI connector
DisplayPort	DisplayPort connector for optional
USB	2 x USB3.0 connector
LAN	RJ45 connector

2.2 <Jumper Location and Reference>

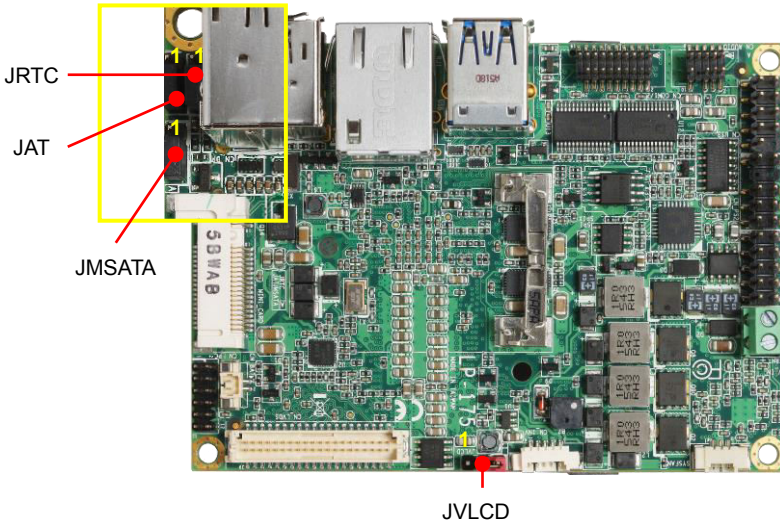

2.2.1 <Jumper list>

Jumper	Function
JAT	Power mode select
JRTC	CMOS Normal/Clear Setting
JVLCD	Panel Voltage Setting
JMSATA	MiniCard mSATA Setting

2.2.2 <Clear CMOS and Power on type selection>

JRTC: Clear CMOS data jumper

Jumper settings	Function
1-2	Clear CMOS
2-3	Normal (Default)

JAT: AT/ATX mode select jumper

Jumper settings	Function
1-2	AT mode
2-3	ATX mode (Default)

2.3 <Installing the Memory>

In the process, the board must be powered off.

1. Put the memory tilt into the slot. Note the Memory notch key aligned slot key.
2. Then press down till lock into the mounting notch.

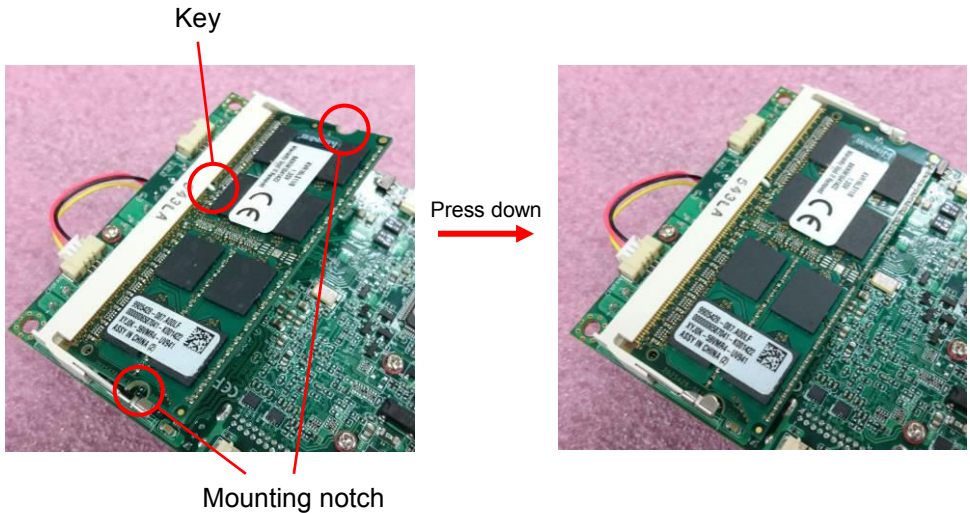

3. To remove the memory, push outward on both sides of the latch.

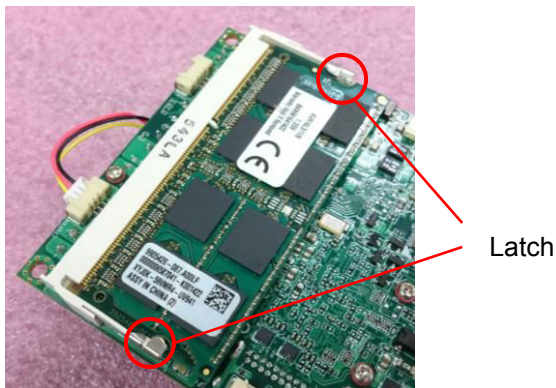

2.4 <I/O interface>

2.4.1 <Serial ATA interface>

CN_SATA3: SATA3 10-pin connector

Pin	Signal
1	GND
2	TX+
3	TX-
4	GND
5	NC
6	NC
7	GND
8	RX-
9	RX+
10	GND

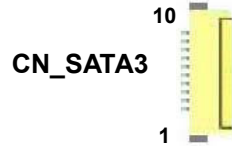

2.4.2 <Ethernet interface>

The board provide I219-LM Gigabit Ethernet which supports WOL on rear I/O.

It supports Intel® AMT 11.0 feature on I219-LM.

(Note that the CPU must support vPro technology, ex: [i5-6300U](#))

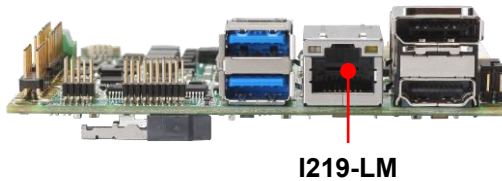

2.4.3 <Display interface>

Based on the 6th Gen CPU with built-in HD Graphics, the DisplayPort resolution up to **3840x2160 @ 60Hz** or **4096x2304 @ 60Hz**, the HDMI up to **4096x2304 @ 24Hz** and LVDS up to **1920x1200 @ 60Hz** support 18/24-bit color depth and dual channel. About select LCD Panel Type in BIOS, please refer [Appendix C](#).

The built-in HD Graphics support triple display function with clone mode and extended mode.

- Note: 1. The HDMI-DP dual layer connector can be changed HDMI & CN_DP to use VGA module.
2. LP-175T series has a CRT, it's no need install extra driver. Here is ADP-3355 Setup manual [Link](#).

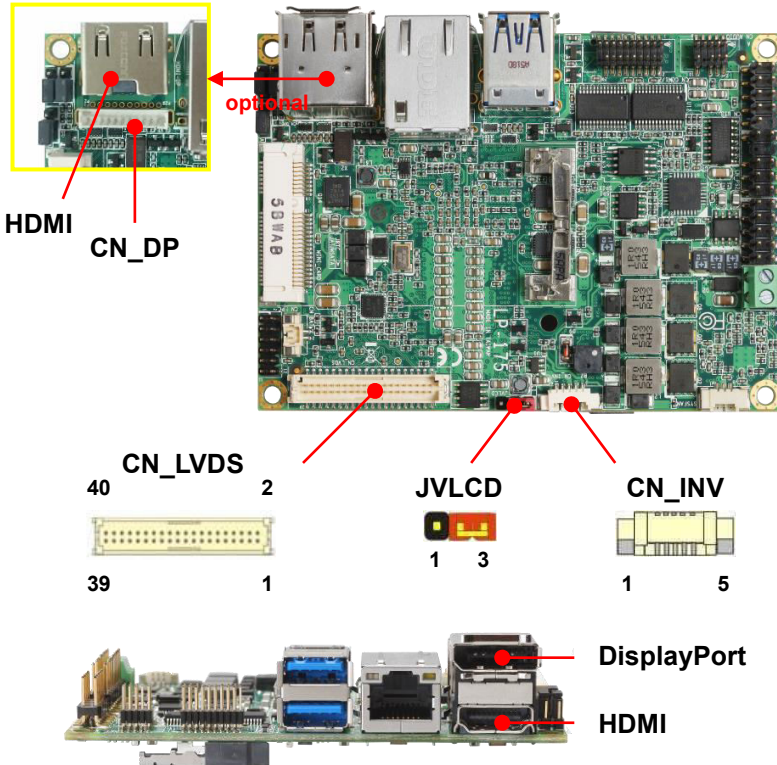

CN_LVDS: LVDS 40-pin connector (Model: HIROSE DF13-40DP-1.25V compatible)

Pin	Signal	Pin	Signal
2	Set by JVLCD	1	Set by JVLCD
4	Detect (Active low)	3	GND
6	A_LVDS_0-	5	B_LVDS_0-
8	A_LVDS_0+	7	B_LVDS_0+
10	GND	9	GND
12	A_LVDS_1-	11	B_LVDS_1-
14	A_LVDS_1+	13	B_LVDS_1+
16	GND	15	GND
18	A_LVDS_2-	17	B_LVDS_2-
20	A_LVDS_2+	19	B_LVDS_2+
22	GND	21	GND
24	A_LVDS_CLK-	23	B_LVDS_3-
26	A_LVDS_CLK+	25	B_LVDS_3+
28	GND	27	GND
30	A_LVDS_3-	29	B_LVDS_CLK-
32	A_LVDS_3+	31	B_LVDS_CLK+
34	GND	33	GND
36	LVDS_DDCSCL	35	NC
38	LVDS_DDCSDA	37	NC
40	NC	39	NC

Note: Pin4 only need to be connected to GND

CN_INV: LVDS 5-pin Backlight power connector

Pin	Signal
1	3.3V
2	Backlight Control
3	5VSB
4	GND
5	Enable Backlight

JVLCD: LVDS panel power select jumper

Jumper settings	Function
1-2	3.3V (Default)
2-3	5V

2.4.4 <Serial Port interface>

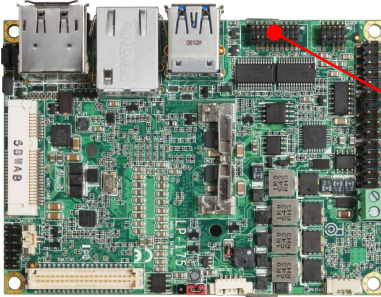
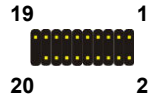
CN_COM1/2

CN_COM1/2: RS232 20-pin header (Pitch 1.27mm x 2.54mm)

Pin	Signal	Pin	Signal
1	DCD1	2	RXD1
3	TXD1	4	DTR1
5	GND	6	DSR1
7	RTS1	8	CTS1
9	RI1	10	NC
11	DCD2	12	RXD2
13	TXD2	14	DTR2
15	GND	16	DSR2
17	RTS2	18	CTS2
19	RI2	20	Key

2.4.5 <USB interface>

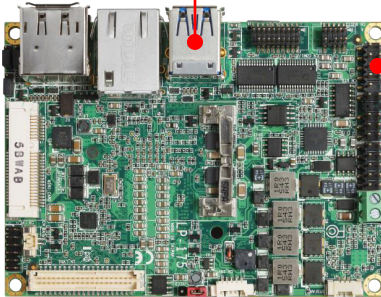
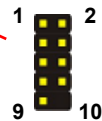
USB3.0

CN_USB

CN_USB: Front panel USB2.0 10-pin header (Pitch 2.54mm)

Pin	Signal	Pin	Signal
1	5VSB	2	5VSB
3	DATA0-	4	DATA1-
5	DATA0+	6	DATA1+
7	GND	8	GND
9	GND	10	Key

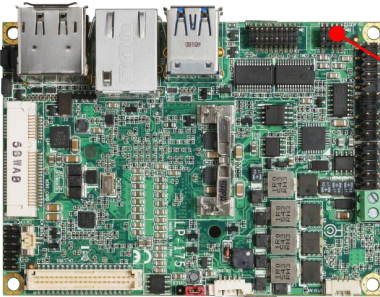
2.4.6 <Audio interface>



CN_AUDIO



CN_AUDIO: Front panel audio 10-pin header (Pitch 1.27mm x 2.54mm)

Pin	Signal	Pin	Signal
1	MIC_L	2	GND
3	MIC_R	4	NC
5	FP_OUT_R	6	MIC_DETECT
7	SENSE	8	Key
9	FP_OUT_L	10	FP_OUT_DETECT

2.4.7 <Expansion slot>

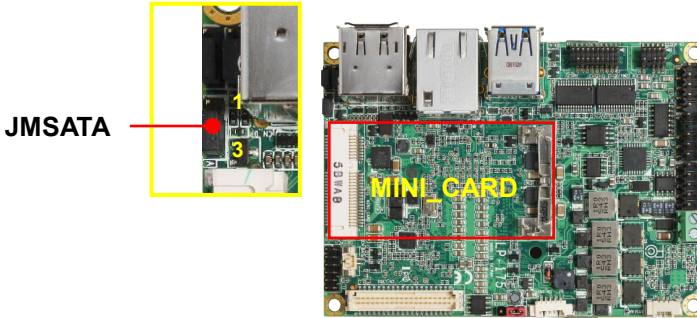

MINI_CARD have some special design to compatible our MiniPCIe card (ex: MPX-574D2, MPX-210D2 etc) and support mSATA set by JMSATA

JMSATA: Setting MINI_CARD to support PCIe/mSATA

Jumper settings	Function
1-2	Support mSATA
2-3	Normal operation (Default)

2.4.8 <Front panel switch and indicator>

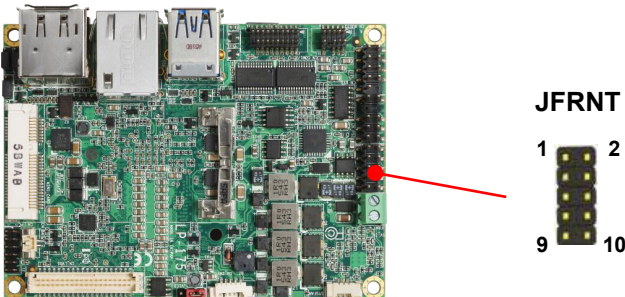

JFRNT: Front panel switch and indicator 14-pin header (Pitch 2.54mm)

Pin	Signal	Pin	Signal
1	Power_ON-	2	Power_ON+
3	Speaker-	4	Speaker+
5	HDD_LED-	6	HDD_LED+
7	Power_LED-	8	Power_LED+
9	Reset+	10	Reset-

2.4.9 <Other interface>

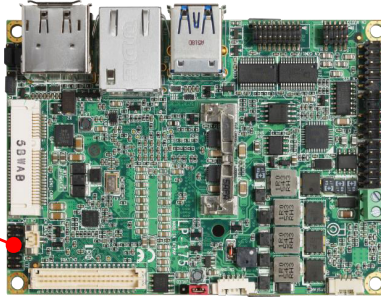
CN_LPC

CN_LPC: LPC 12-pin header (Pitch 2.00mm)

Pin	Signal	Pin	Signal
1	CLK	2	RST
3	-LFRAME	4	LAD3
5	LAD2	6	LAD1
7	LAD0	8	3.3V
9	SERIRQ	10	GND
11	3.3VSB	12	NC

Note: Support TPM module.

CPUFAN: CPU cooler fan 3-pin connector

Pin	1	2	3
Signal	GND	5V	Sensor

SYSFAN: System cooler fan 3-pin connector

Pin	1	2	3
Signal	GND	5V	Sensor

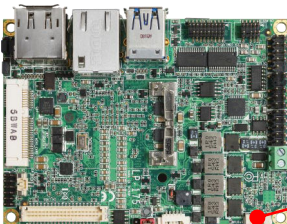
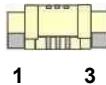
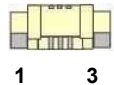
SYSFAN

CPUFAN

2.5 <Power supply>

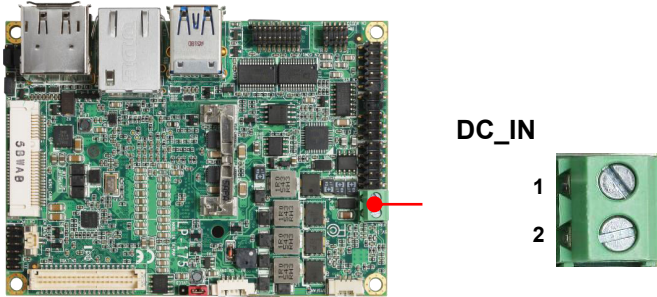
2.5.1 <Power input>



Only supports 5V power input.

DC_IN: Terminal Block 2-pin power connector

Pin	Signal	Pin	Signal
1	GND	2	Power in

2.5.2 <Power output>

DC_OUT: SATA power 6-pin connector

Pin	Signal
1	NC
2	NC
3	GND
4	GND
5	5V
6	5V

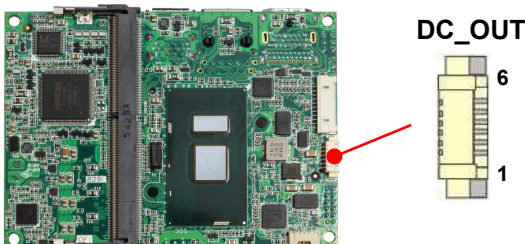

Appendix A <Flash BIOS>

A.1 <Flash tool>

The board is based on Phoenix BIOS and can be updated easily by the BIOS auto flash tool. You can download the tool online at the address below:

[LP-175 reflash tool](#)

The tool's file name is "fpt.exe", it's the utility that can write the data into the BIOS flash chip and update the BIOS.

A.2 <Flash BIOS process>

1. Please make a bootable UFD which can boot into DOS environment.
2. Unzip the flash tool and copy it into bootable UFD.
3. Add a bin file to the same folder..
4. Power on the system and flash the BIOS under the DOS environment.
(Command: fpt -savemac -f xxx.bin)
5. Power off the system and then power on.

Appendix B <Win7 Installation Notes>

B.1 <ME driver>

Before installing, it need to install Microsoft Hotfix KB2685611 first for Win7 32/64 bit. More information please refer

<https://www.microsoft.com/en-us/download/details.aspx?id=38423>

B.2 <USB3.0 driver>

The Skylake platform removed EHCI host controller, therefore, before install new Win7 OS, need to embed the USB3.0 driver to Win7 installation image file, for more information, please refer Intel document.

Appendix C <LCD Panel Type select>

According to your panel, it needs to select the correct resolution in the BIOS. If there is no fit for your panel type, please provide feedback for us to make an OEM model.

BIOS panel type selection form (BIOS Version:1.0)			
Single / Dual channel		Single / Dual channel	
NO.	Type	NO.	Type
1	640 x 480	9	1680 x 1050
2	800 x 600	10	1920 x 1200
3	1024 x 768	11	1440 x 900
4	1280 x 1024	12	1600 x 900
5	1400 x 1050 Reduced Blanking	13	1024 x 768
6	1400 x 1050 non-Reduced Blanking	14	1280 x 800
7	1600 x 1200	15	1920 x 1080
8	1366 x 768	16	OEM Keep (Ver 1.0)

Appendix D <Programmable Watch Dog Timer>

Timeout value range

1 to 255 Minute and Second

Program sample

Watchdog timer setup as system reset with 5 second of timeout

```
-o 4E 87      ;enter configuration
-o 4E 87
-o 4E 07
-o 4F 08      ;select Logical Device
-o 4E 30
-o 4F 01      ;activate WDTO# function
-o 4E F5
-o 4F 00      ;set "00" is second mode, set "04" is minute mode
-o 4E F6
-o 4F 05      ;00h: Timeout Disable
                ;01h: Timeout occurs after 1 minute only
                ;02h: Timeout occurs after 2 second/minute
                ;03h: Timeout occurs after 3 second/minute
                ;
                ;FFh: Timeout occurs after 255 second/minute
                (The deviation is approx 1 second.)
```

For further information, please refer to Nuvoton NCT6106D datasheet

Contact information

Any advice or comment about our products and service, or anything we can help you please don't hesitate to contact with us. We will do our best to support you for your products, projects and business.

Taiwan Commate computer Inc.

Address	19F., NO.94, Sec. 1, Xintai 5 th Rd., Xizhi Dist., New Taipei City 22102, Taiwan.
TEL	+886-2-26963909
FAX	+886-2-26963911
Website	www.commell.com.tw
E-mail	info@commell.com.tw (General information) tech@commell.com.tw (Technical Support)

Commell is a brand name of Taiwan Commate computer Inc.