



User's Manual

3300020

This Page is Intentionally Left Blank.

ESD Precautions

Integrated circuits on computer boards are sensitive to static electricity. To avoid damaging chips from electrostatic discharge, observe the following precautions:

- „ Do not remove boards or integrated circuits from their anti-static packaging until you are ready to install them.
- „ Before handling a board or integrated circuit, touch an unpainted portion of the system unit chassis for a few seconds. This helps to discharge any static electricity on your body.
- „ Wear a wrist-grounding strap, available from most electronic component stores, when handling boards and components.

Trademarks Acknowledgments

MS-DOS and Windows '95 are trademarks of Microsoft Corporation.

AWARD is a trademark of Award Software. Inc.

IBM, PC/AT, PS/2, VGA are trademarks of International Business Machines Corporation.

Intel and Pentium are trademarks of Intel Corporation.

Winbond is a trademark of Winbond Electronics Corp.

SMI is a trademark of Silicon Motion Inc.

Other brand names and trademarks are the properties and registered brands of their respective owners.

Table of Contents

Chapter 1 Introduction.....	1
1.1 Specifications	2
1.2 Utilities Supported.....	4
Chapter 2 Jumpers and Connectors.....	5
2.1 Board Layout and Fixing Holes.....	5
2.2 Placement.....	6
2.3 Jumper Settings.....	7
2.3.1 Audio Output Select Jumper: JP1	8
2.3.2 CMOS Clear Jumper: JP2	8
2.3.3 Watchdog Enable: JP3.....	8
2.3.4 CompactFlash Setting: JP4	8
2.3.5 VCCM of CN7/CN17 Voltage: JP5.....	8
2.3.6 Compact Flash Power: JP6	8
2.3.7 PCI-X Slot VIO power: JP14	9
2.3.8 VCCM of CN5/CN6 Voltage: JP15.....	9
2.3.9 COM1~COM4 Mode for Power:	9
2.3.10 COM2 Mode Select for Type:.....	10
2.3.11 CompactFlash Setting: JP4	10
2.4 Connectors.....	11
Chapter 3 Hardware Description.....	13
3.1 Microprocessors.....	13
3.2 BIOS.....	13
3.3 System Memory	13
3.4 I/O Port Address Map	14
3.5 Interrupt Controller	15
3.6 IDE Interface Connector	16

3.7 Display Interface	18
3.7.1 Graphic Controller	18
3.7.2 Features.....	18
3.7.3 VGA/Flat Panel Connectors.....	19
3.8 Floppy Disk Controller	21
3.9 Parallel Port Interface.....	22
3.10 Serial Port Interface.....	23
3.10.1 Serial Ports IRQ Selection.....	23
3.10.2 Serial Ports Power Selection	23
3.11 Real Time Clock and CMOS RAM.....	24
3.12 Keyboard and PS/2 Mouse Connector.....	25
3.13 USB Connector	26
3.14 Ethernet RJ-45 Connector	26
3.15 CPU and System Fan Connectors.....	27
3.16 PC/104+ Connectors.....	27
3.17 PICMG compliant PCI-X Connector	29
3.18 Audio Connector.....	34
3.19 Compact Flash™ Socket (CN26).....	34
3.20 Pin Assignments of Other Connectors.....	36
Chapter 4 Award BIOS Utility	39
4.1 Entering Setup	39
4.2 Control Keys	40
4.3 Getting Help	41
4.4 The Main Menu.....	42
4.5 Standard CMOS Setup Menu	43
4.6 Advanced BIOS Features.....	46
4.7 Advanced Chipset Features	51
4.8 Integrated Peripherals.....	53
4.9 Power Management Setup	58
4.10 PnP/PCI Configuration Setup	63
4.11 PC Health Status.....	65
4.12 Frequency/Voltage Control.....	66

4.13 Load Fail-Safe Defaults	67
4.14 Load Optimized Defaults.....	68
4.15 Set Supervisor/User Password	69
4.16 Save & Exit Setup	70
4.17 Exit Without Saving.....	71
Appendix A Watchdog Timer	73
Appendix B Serial ATA Setup Information.....	79

Chapter 1

Introduction



The **3300020A** is an Intel® Pentium® M/Celeron™ M CPU equipped Petit board with graphics, Fast Ethernet and audio interface. Designed with the space-limited applications in mind, the **3300020A** is practically the finest embedded Pentium® M board that exists. Using a standardized format conforming to the size of a 5.25" CD-ROM drive, **3300020 Series** adapt an Intel® low power consumption Pentium® M microprocessors. To simplify system integration, it packs provisions such as super I/Os, XVGA, LCD, Ethernet, solid state disk, all on a single board. Unique embedded features such as 4 serial ports (3 x RS-232, 1 x RS-232/422/485) with +5V/12V power capability and that allow adoption of an extensive array of PC peripherals. The industrial-grade construction of **3300020 series** allows your system to endure the continuous operation in hostile environments where stability and reliability are basic requirements. System dependability of **3300020 series** are enhanced by its built-in watchdog timer, a special industrial feature not commonly seen on other motherboards.

Designed for the professional embedded developers, the Pentium® M embedded board **3300020 Series** is virtually the ultimate one-step solution for embedded system applications.

1.1 Specifications

- z CPU: Intel® Pentium® M and Celeron® M
- z System Chipset: Intel® 855GME/852GM + 6300ESB
- z Bus Clock: 400 MHz
- z BIOS:
 - „ Phoenix-Award BIOS, Y2K compliant
 - „ 4Mbit Flash, DMI, Plug and Play
 - „ SmartView for multiple LCD type selection, display mode option and application extension features
 - „ RPL/PXE Ethernet Boot ROM
 - „ “Load Optimized Default” to backup customized Setting in the BIOS flash chip to prevent from CMOS battery fail
- z System Memory:
 - „ One 184-pin DIMM socket
 - „ 200/266/333MHz ECC/non-ECC DDR SDRAM supported
 - „ Maximum SDRAM of up to 1GB
- z L2 Cache: integrated in CPU
- z Onboard IDE:
 - „ 4 channels up to 6 devices (2 parallel ATA-100 and 2 serial ATA-150)
 - „ RATA-100 as PIO Mode 0-4, DMA Mode 0-2 and Ultra DMA/33/66/100
- z Onboard Serial ATA:
 - „ Independent DMA operation on two ports.
 - „ Data transfer rate up to 150 Mbyte/s
 - „ Alternate Device IDE and RAID Class Code option for support of Soft RAID.
- z Compact Flash Socket:
 - „ IDE1 support Compact Flash type-II Socket jumper selectable as Master or Slave and DMA mode supported
 - „ Power is 5V (default) or 3.3V (Option).

- z Onboard Multi I/O:
 - „ One floppy port supporting up to two devices (LS-120 & ZIP Bootable)
 - „ One SPP/EPP/ECP parallel port; supports LS-120
 - „ Four 16550 UART-compatible serial ports with +5V/+12V power output in Pin 1 or Pin 9 via DIP jumper setting.
 - 3 x RS-232
 - 1 x RS-232/422/485 and selectable via jumper setting and auto flow control supported
 - „ 1 x IrDA for wireless communication
- z USB Interface: 4 USB ports with fuse protection and complies with USB Spec. Rev. 2.0
- z Real Time Clock: Integrate Intel® 6300ESB
- z Watchdog Timer:
 - „ Integrate Intel® 6300ESB
 - „ Up to 1024 levels as Reset/SMI features
- z Board Unique ID:
 - „ Dallas DS2401 board unique ID supported for customized application
- z Hardware Monitoring:
 - „ Integrate Winbond W83627HF Super I/O.
 - „ Monitoring for CPU/System temperatures, System Voltage and Chassis/CPU Fan speeds
- z Graphics/Streaming:
 - „ Integrate Intel® 855GME/852GM GMCH
 - „ Unified Memory Architecture shares system memory up to 256MB
 - „ Single display mode maximum resolutions:
 - < CRT: 1600 x 1200
 - < LVDS LCD: 1280 x 1024
 - „ DualView display mode:
 - < CRT: 1600 x 1200
 - < LVDS LCD: 1280 x 1024
 - „ LCD backlight control supported
 - „ Optional Dual LVDS LCD via Chrontel CH7305 converter

- z Ethernet:
 - „ Realtek 8100C PCI Bus 10/100M Base-T
 - „ Wake On LAN (via ATX power supply)
 - „ Equipped with RJ-45 interface
 - „ Optional with Realtek RTL8110S for 10/100/1000Base-T
 - z Audio:
 - „ Realtek ALC202A AC'97 codec audio
 - „ Amplify for speaker-out with 2.5W for each channel
 - „ MIC-in, Line-in, Line-out/Speaker-out (jumper selectable)
 - z Expansion Slots:
 - „ One 32-bit PC/104 Plus connector for 3 Masters and 1 slave expansion
 - „ One PCI-X slot for default 2 PCI-X expansion (optional up to 4 masters support)
 - „ One Mini-PCI type-III Socket
 - z Power Management: ACPI (Advanced Configuration and Power Interface)
 - z Form Factor: 5.25" CD-ROM drive form factor
 - z Dimensions: 203.20 x 146.05 mm²
- NOTE: *Specifications are subject to change without notice.*

1.2 Utilities Supported

- z Chipset Driver
- z Ethernet Driver
- z VGA Drivers
- z Audio Drivers

Jumpers and Connectors

2.1 Board Layout and Fixing Holes

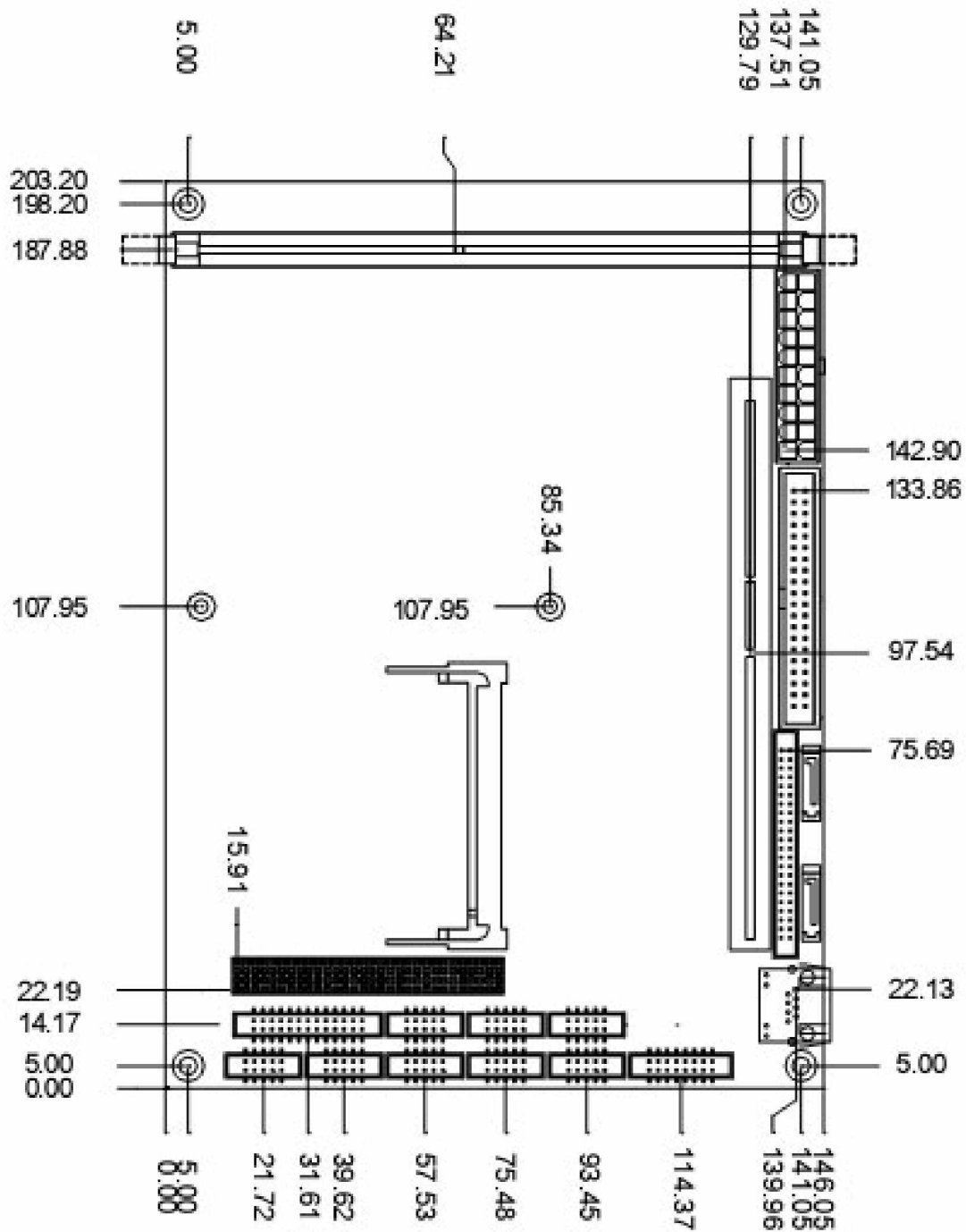

2.2 Placement

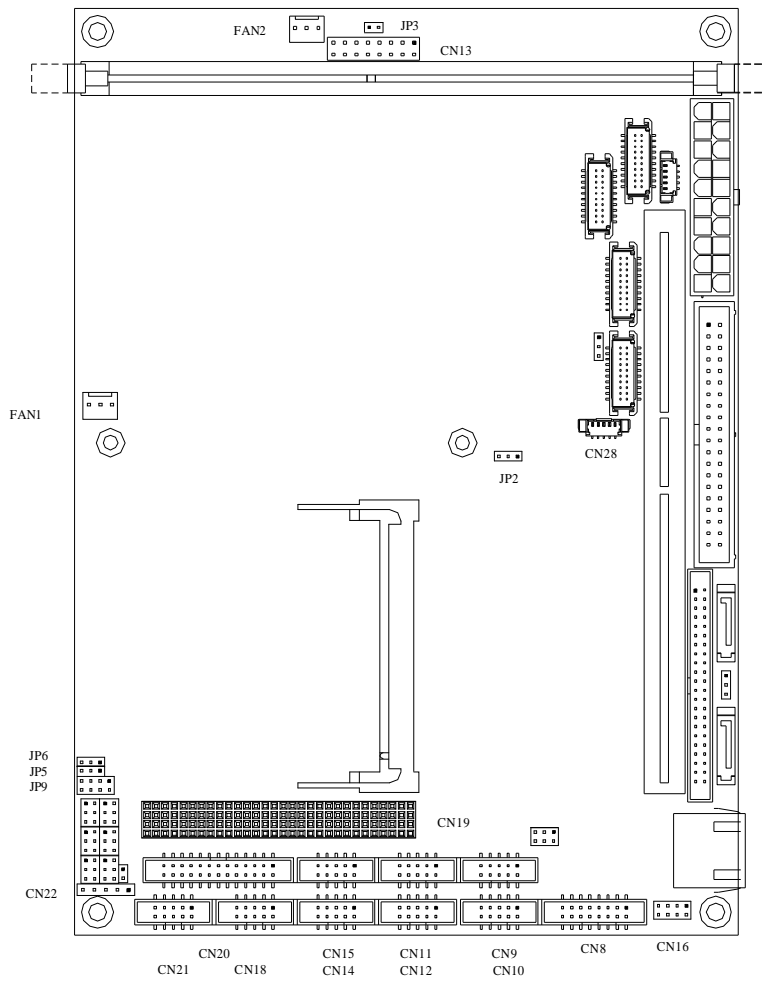

2.3 Jumper Settings

The **3300020 Series** is configured to match the needs of your application with the proper jumper settings. The table below is a summary of all the jumpers and their corresponding functions onboard the **3300020 Series**. The succeeding tables show the correct jumper settings for the onboard devices.

Jumper	Default Setting		Jumper Setting
JP1	Audio Line Out/Speaker Out: Line Out		Short 1-3, 2-4
JP2	Clear CMOS Setting: Normal		Short 1-2
JP3	Watchdog Trigger : Disabled		Open
JP4	Compact Flash Setting: Slave		Open
JP5	VCCM of CN7/CN17 Voltage select:3.3V		Short 1-2
JP6	Compact Flash Power Select: 3.3V		Short 1-2
JP7	COM3 Mode Select	CN21 Pin 1: DCD	Short 3-5
		CN21 Pin 8: RI	Short 4-6
JP8	COM1 Mode Select	CN14 Pin 1: DCD	Short 3-5
		CN14 Pin 8: RI	Short 4-6
JP9	COM2 Mode Select: RS-232		Short 1-2
JP10	COM2 Mode Select: RS-232		Short 3-5,4-6
JP11	COM2 Mode Select: RS-232		Short 3-5,4-6
JP12	COM4 Mode Select	CN15 Pin 1: DCD	Short 7-9
		CN15 Pin 8: RI	Short 8-10
JP13	COM2 Mode Select	CN18 Pin 1: DCD	Short 7-9
		CN18 Pin 8: RI	Short 8-10
JP14	PCI Slot VIO Select: 3.3V		Short 1-2
JP15	VCCM of CN5/CN6 Voltage select:3.3V		Short 1-2

2.3.1 Audio Output Select Jumper: JP1

Options	Settings
Line Out	Short 1-3, 2-4 (default)
Speaker Out	Short 3-5, 4-6

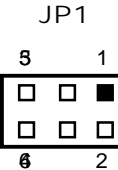

2.3.2 CMOS Clear Jumper: JP2

Options	Settings
Normal	Short 1-2 (default)
Clear CMOS	Short 2-3

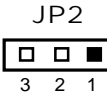

2.3.3 Watchdog Enable: JP3

Options	Settings
Disable	Open
Enable	Short



2.3.4 CompactFlash Setting: JP4

Options	Settings
Slave	Open
Master	Short



2.3.5 VCCM of CN7/CN17 Voltage: JP5

Options	Settings
3.3V	Short 1-2
5V	Short 2-3

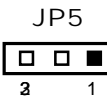

2.3.6 Compact Flash Power: JP6

Options	Settings
3.3V	Short 1-2
5V	Short 2-3

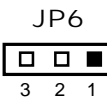

2.3.7 PCI-X Slot VIO power: JP14

Options	Settings
3.3V	Short 1-2
5V	Short 2-3

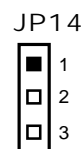

2.3.8 VCCM of CN5/CN6 Voltage: JP15

Options	Settings
3.3V	Short 1-2
5V	Short 2-3

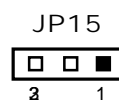

2.3.9 COM1~COM4 Mode for Power:

COM1(CN14)	JP8
Pin 1=5V	Short 1-3
*Pin 1=DCD	Short 3-5
Pin 8=12V	Short 2-4
*Pin 8=RI	Short 4-6

COM2(CN18)	JP13
Pin 1=5V	Short 1-3
*Pin 1=DCD	Short 3-5
Pin 8=12V	Short 2-4
*Pin 8=RI	Short 4-6

COM3(CN21)	JP7
Pin 1=5V	Short 1-3
*Pin 1=DCD	Short 3-5
Pin 8=12V	Short 2-4
*Pin 8=RI	Short 4-6

COM4(CN15)	JP12
Pin 1=5V	Short 1-3
*Pin 1=DCD	Short 3-5
Pin 8=12V	Short 2-4
*Pin 8=RI	Short 4-6

*: **Default settings**

JP7/8/12/13

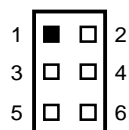

2.3.10 COM2 Mode Select for Type:

COM2	JP9	JP10	JP11
RS-232 (default)	1-2	3-5, 4-6	3-5, 4-6
RS-422	3-4, 7-8	1-3, 2-4	1-3, 2-4
RS-485	5-6, 7-8	1-3, 2-4	1-3, 2-4



2.3.11 CompactFlash Setting: JP4

Options	Settings
Slave	Open(default)
Master	Short 1-2

2.4 Connectors

The connectors allow the CPU card to connect with other parts of the system. Some problems encountered by your system may be a result from loose or improper connections. Ensure that all connectors are in place and firmly attached. The following table lists the function of each connector on the **3300020 Series**. Their corresponding pin assignments are described in Chapter 3.

Connectors	Label	Connectors	Label
ATX Power Connector	CN1	LAN LED Connector	CN16
40-pin IDE2 Connector	CN2	Ch2 of LVDS1 Connector	CN17
44-pin IDE1 Connector	CN3	COM2 Connector	CN18
LAN Connector	CN4	PC104 Plus Connector	CN19
Ch1 of LVDS2 Connector	CN5	LPT1 Connector	CN20
Ch2 of LVDS2 Connector	CN6	COM3 Connector	CN21
Ch1 of LVDS1 Connector	CN7	IR Connector	CN22
VGA Connector	CN8	SATA0 Connector	CN23
Audio connector	CN9	SATA1 Connector	CN24
K/B & M/S Connector	CN10	FDD Connector	CN25
USB2/3 Connector	CN11	Compact Flash Socket	CN26
USB0/1 Connector	CN12	Inverter Connector for LVDS1	CN27
Front Panel Bezel Connector	CN13	Inverter Connector for LVDS2	CN28
COM1 Connector	CN14	Mini-PCI Socket	J1
COM4 Connector	CN15	PCI-X Slot	PCI1

This page does not contain any information.

Chapter 3

Hardware Description

3.1 Microprocessors

The **3300020 Series** supports Intel® Celeron™ M and Pentium® M CPUs. Systems based on these CPUs can be operated under Windows 2000/XP and Linux environments. The system performance depends on the microprocessor installed onboard. Make sure all settings are correct for the installed microprocessor to prevent any damage to the CPU.

3.2 BIOS

System BIOS used on the **3300020 Series** is Phoenix-Award Plug and Play BIOS. The **3300020 Series** contains a single 4Mbit Flash.

3.3 System Memory

The **3300020 Series** industrial CPU card supports one 184-pin DDR DIMM socket for a maximum memory of 1GB DDR SDRAMs. The memory module can come in sizes of 64MB, 128MB, 256MB, 512MB and 1GB.

3.4 I/O Port Address Map

The Intel® Pentium® M/Celeron™ M CPU communicates via I/O ports. It has a total of 1KB port addresses available for assignment to other devices via I/O expansion cards.

Address	Devices
000-01F	DMA controller #1
020-03F	Interrupt controller #1
040-05F	Timer
060-06F	Keyboard controller
070-07F	Real time clock, NMI
080-09F	DMA page register
0A0-0BF	Interrupt controller #2
0C0-0DF	DMA controller #2
0F0	Clear math coprocessor busy signal
0F1	Reset math coprocessor
0F8-0FF	Math processor
1F0-1F8	Fixed disk controller
250-25F	HR I/O
300-31F	Prototype card
380-38F	SDLC #2
3A0-3AF	SDLC #1
3B0-3BF	MDA video card (including LPT1)
3C0-3CF	EGA card
3D0-3DF	CGA card
3F0-3F7	Floppy disk controller
3F8-3FF	Serial port #1 (COM1)
3E8-3EF	Serial port #3 (COM3)
2F8-2FF	Serial port #2 (COM2)
2E8-2EF	Serial port #4 (COM4)
3F0-3FF	Super I/O

3.5 Interrupt Controller

The **3300020 Series** is a 100% PC compatible control board. It consists of 16 interrupt request lines. Four out of the sixteen can either be programmable. The mapping list of the 16 interrupt request lines is shown on the following table.

NMI	Parity check error
IRQ0	System timer output
IRQ1	Keyboard
IRQ2	Interrupt rerouting from IRQ8 through IRQ15
IRQ3	Serial port #2
IRQ4	Serial port #1
IRQ5	Reserved
IRQ6	Floppy disk controller
IRQ7	Parallel port #1
IRQ8	Real time clock
IRQ9	Reserved
IRQ10	Serial port #3
IRQ11	Serial port #4
IRQ12	PS/2 Mouse
IRQ13	Math coprocessor
IRQ14	Primary IDE channel
IRQ15	Secondary IDE Channel

3.6 IDE Interface Connector

The built-in 4 channels of IDE (2 parallel ATA-100 and 2 serial ATA-150) support up to 6 IDE devices; master/slave mode for parallel ATA-100 and post write transaction mechanisms with 64-byte buffer, and master data transaction. **CN3** is a 44-pin IDE interface connector for standard 2.5" IDE device. **CN2** is a 40-pin IDE interface connector for standard 3.5" IDE device. **CN23** and **CN24** are the serial ATA-150 IDE interfaces currently support the hard disk drives.

CN3: IDE Connector Pin Assignment

Pin	Description	Pin	Description	Pin	Description
1	Reset #	2	GND	3	Data 7
4	Data 8	5	Data 6	6	Data 9
7	Data 5	8	Data 10	9	Data 4
10	Data 11	11	Data 3	12	Data 12
13	Data 2	14	Data 13	15	Data 1
16	Data 14	17	Data 0	18	Data 15
19	GND	20	No connector	21	No connector
22	GND	23	IOW #	24	GND
25	IOR #	26	GND	27	IOCHRDY
28	No connector	29	No connector	30	GND-Default
31	Interrupt	32	No connector	33	SA1
34	No connector	35	SA0	36	SA2
37	HDC CS0 #	38	HDC CSI #	39	HDD Active #
40	GND	41	Vcc	42	Vcc
43	GND	44	No connector		

CN2: 40-pin IDE Connector Pin Assignment

Pin	Description	Pin	Description	Pin	Description
1	Reset #	2	GND	3	Data 7
4	Data 8	5	Data 6	6	Data 9
7	Data 5	8	Data 10	9	Data 4
10	Data 11	11	Data 3	12	Data 12
13	Data 2	14	Data 13	15	Data 1
16	Data 14	17	Data 0	18	Data 15
19	GND	20	No connector	21	No connector
22	GND	23	IOW #	24	GND
25	IOR #	26	GND	27	IOCHRDY
28	No connector	29	No connector	30	GND-Default
31	Interrupt	32	No connector	33	SA1
34	No connector	35	SA0	36	SA2
37	HDC CS0 #	38	HDC CSI #	39	HDD Active #
40	GND				

CN23/24: 7-pin SATA Connector Pin Assignment

PIN	Description
1	GND
2	TX+
3	TX-
4	GND
5	RX-
6	RX+
7	GND

3.7 Display Interface

3.7.1 Graphic Controller

The 855GME provides a highly integrated graphics accelerator delivering high performance 2D, 3D, and video capabilities. With its interfaces to UMA using a DVMT configuration, an analog display (CRT port), a LVDS port for digital LCD connection and optional second LVDS LCD interface (via Chrontel CH7305 converter), the 855GME can provide a complete graphics solution. The 855GME also provides 2D hardware acceleration for block transfers of data (BLTs). Performing these common tasks in hardware reduces CPU load, and thus improves performance. High bandwidth access to data is provided through the system memory interface. The 855GME uses Tiling architecture to increase system memory efficiency and thus maximize effective rendering bandwidth. The Intel 855GME GMCH improves 3D performance and quality with 3D Zone rendering technology. The Intel 855GME GMCH also supports Video Mixer rendering and Bi-Cubic filtering.

3.7.2 Features

- z The 3300020 adapts Intel 855GME GMCH provides three display ports, one analog and two digital. With these interfaces, the GMCH can support for a progressive scan analog monitor, a dedicated single/dual channel LVDS LCD panel and a converted LVDS LCD interface through DVO channel. Each port can transmit data according to one or more protocols. The data that is sent out the display port is selected from one of the two possible sources, Pipe A or Pipe B.
- z Intel 855GME GMCH has an integrated 350-MHz, 24-bit RAMDAC that can directly drive a progressive scan analog monitor pixel resolution up to 1600x1200 at 85-Hz refresh and up to 2048x1536 at 75-Hz refresh. The Analog display port can be driven by Pipe A or Pipe B.

- z The Intel 855GME GMCH have an integrated dual channel LFP Transmitter interface to support LVDS LCD panel resolutions up to UXGA. The display pipe provides panel up-scaling to fit a smaller source image onto a specific native panel size, as well as provides panning and centering support. The LVDS port is only supported on Pipe B. The LVDS port can only be driven by Pipe B, either independently or simultaneously with the Analog Display port. Spread Spectrum Clocking is supported: center and down spread support of 0.5%, 1%, and 2.5% utilizing an external SSC clock.

3.7.3 VGA/Flat Panel Connectors

The **3300020 Series** has one connector that supports CRT/VGA. **CN8** is a SMD 16 Pin header connector used for the CRT VGA display, and **CN7 & CN17** are Hirose DF-13 20pin connector for LVDS Interface LCD. **CN7** for Channel 1, **CN17** for channel 2. **CN12** is inverter connector for LCD to support the system LCD backlight control with OS and driver independent.

CN8: CRT/VGA Connector Pin Assignment

Pin	Description	Pin	Description
1	RED	2	GND
3	GREEN	4	NC
5	BLUE	6	GND
7	NC	8	DDC_DATA
9	GND	10	GND
11	GND	12	HSYNC
13	GND	14	VSYNC
15	DDC_CLK	16	NC

CN7/CN17: Hirose Connector for LVDS Flat Panel

Pin	Deception	Pin	Deception
1	VCCM	2	VCCM
3	VCCM	4	VCCM
5	D0-	6	D3-
7	D0+	8	D3+
9	GND	10	GND
11	D1-	12	CLK-
13	D1+	14	CLK+
15	GND	16	GND
17	D2-	18	GND
19	D2+	20	GND

CN12: Hirose Connector for Inverter

PIN	Description
1	12VM
2	5V
3	12VM
4	ENAB
5	GND

3.8 Floppy Disk Controller

The **3300020 Series** provides a 26-pin FCC Z.I.F. type connector, **CN25** for support of a single floppy drives. The floppy drive could be any one of the following types: 3.5" 720KB or 1.44MB/2.88MB.

CN25: FDD Connector Pin Assignment

Pin	Description	Pin	Description
1	+5V	14	STEP
2	INDEX	15	GND
3	+5V	16	WDATA
4	DRIVE0	17	GND
5	+5V	18	WGATE
6	DSKCHG	19	GND
7	No connector	20	TRK0
8	READY	21	GND
9	HDOUT	22	WPT
10	MOTOR ON	23	GND
11	No connector	24	RDATA
12	DIR	25	GND
13	HDSEL	26	SIDE0

3.9 Parallel Port Interface

The **3300020 Series** has one onboard parallel port, LPT1. LPT1 has one 26-pin header connector. The onboard **PRN** of **3300020 Series** is a multi-mode parallel port supporting:

- z Standard mode:
IBM PC/XT, PC/AT and PS/2 compatible with bi-directional parallel port
- z Enhanced mode:
Enhance parallel port (EPP) compatible with EPP 1.7 and EPP 1.9 (IEEE 1284 compliant)
- z High speed mode:
Microsoft and Hewlett Packard extended capabilities port (ECP) IEEE 1284 compliant

The address selection of the onboard parallel port, in LPT1 (378H) or disabled, is configured within the BIOS CMOS setup utility.

CN20: Parallel Port Connector Pin Assignment

Pin	Description	Pin	Description
1	Strobe#	14	Auto Form Feed#
2	Data 0	15	Error#
3	Data 1	16	Initialize#
4	Data 2	17	Printer Select In#
5	Data 3	18	GND
6	Data 4	19	GND
7	Data 5	20	GND
8	Data 6	21	GND
9	Data 7	22	GND
10	Acknowledge#	23	GND
11	Busy	24	GND
12	Paper Empty#	25	GND
13	Printer Select	26	No connector

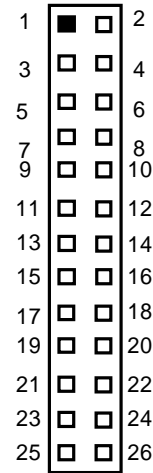

3.10 Serial Port Interface

The **3300020 Series** has four onboard serial ports, **COM1**, **COM2** and **COM3** are RS-232 and **COM2** is RS-232/422/485, jumper selectable with auto flow control features. All four ports feature +5V/12V power capability on DCD and RI, depending on the jumper setting.

3.10.1 Serial Ports IRQ Selection

IRQ for **COM1** and **COM2** are selected on IRQ4 or IRQ3. Both ports can be enabled or disabled via BIOS setting. The IRQ for **COM3** and **COM4** is selected on 10 or 11 by BIOS setting.

3.10.2 Serial Ports Power Selection

The four COM ports have +5V power capability on DCD and +12V power capability for RI, depending on the jumper setting. (See Section 2.3.3). The RS-232 pin assignments are listed on the following table.

CN14, CN18, CN21, CN15:

COM1, COM2, COM3, COM4 Serial Port 10-pin Connector Pin Assignment

Pin	Description	Pin	Description
1	Data Carrier Detect (DCD)	2	Data Set Ready (DSR)
3	Receive Data (RXD)	4	Request to Send (RTS)
5	Transmit Data (TXD)	6	Clear to Send (CTS)
7	Data Terminal Ready (DTR)	8	Ring Indicator (RI)
9	Ground (GND)	10	No connector



The RS-422/485 pin assignments for COM2 are listed below.

Pin #	Signal Name	
	R2-422	RS-485
1	TX-	DATA-
2	No connector	No connector
3	TX+	DATA+
4	No connector	No connector
5	RX+	No connector
6	No connector	No connector
7	RX-	No connector
8	No connector	No connector
9	GND	GND
10	No connector	No connector

3.11 Real Time Clock and CMOS RAM

The **3300020 Series** contains 63000EB Integrated Real Time Clock (RTC) and 128 bytes of CMOS RAM. The CMOS RAM stores the system configuration information entered via the SETUP program. A battery keeps the stored information on the RTC and CMOS RAM active when system power is turned off.

3.12 Keyboard and PS/2 Mouse Connector

The **3300020 Series** provides a keyboard and PS/2 mouse interface. **CN10** is a pin-header connector for keyboard and PS/2 mouse connection.

CN10

Pin	Description	Pin	Description
1	+5V	2	Keyboard Data
3	Keyboard Clock	4	Ground (GND)
5	+5V	6	+5V
7	Mouse Data	8	Mouse Clock
9	Ground (GND)	10	No connector



3.13 USB Connector

The **3300020 Series** features four Universal Serial Bus (USB) connectors as USB 2.0 compliant (480Mbps) that can adapt any USB peripherals, such as monitor, keyboard and mouse etc. The **3300020 Series** has two box-header connectors (**CN11/12**).

CN11/12: USB Connector Pin Assignment

Pin	Description	Pin	Description
1	VCC	2	VCC
3	D0-	4	D1-
5	D0+	6	D1+
7	Ground (GND)	8	Ground (GND)
9	Ground (GND)	10	Ground (GND)

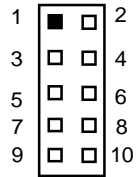

3.14 Ethernet RJ-45 Connector

The RJ-45 connector is used for Ethernet. To connect the **3300020** to a 100/10 Base-T hub, just plug one end of the cable into the **CN4** and connect the other end of the cable to a 1000/100/10-Base-T hub.

CN4: RJ-45 Connector Pin Assignment

Pin	Signal
1	TX+ (Data transmission positive)
2	TX- (Data transmission negative)
3	Rx+ (Data reception positive)
4	RJ45 termination
5	RJ45 termination
6	Rx- (Data reception negative)
7	RJ45 termination
8	RJ45 termination

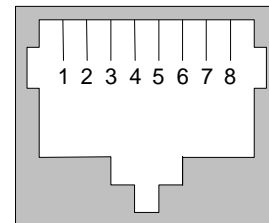

RJ-45

3.15 CPU and System Fan Connectors

FAN1 and **FAN2** are CPU and system fan connectors. Pentium microprocessors require a fan for heat dispensing. The fan connector on **3300020 Series** provides power to the fan.

Pin	Description
1	GND
2	+12V
3	Sensor

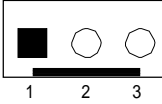

3.16 PC/104+ Connectors

The PC/104+ Plus is an industrial standard. It is a compact form factor with dimensions of 3.6" x 3.8" and is fully compatible with the PCI Bus. The PC/104+ interface are able to adapt off-the-shelf PC/104+ modules, such as sound module, fax modem module and multi-I/O module...etc.

CN19: PC/104+ Bus Pin Assignment

Pin#	Pin Name	Pin#	Pin Name	Pin#	Pin Name	Pin#	Pin Name
A1	N.C	B1	Reserved	C1	+5V	D1	AD0
A2	N.C	B2	AD2	C2	AD1	D2	+5V
A3	AD5	B3	GND	C3	AD4	D3	AD3
A4	C/BE0#	B4	AD7	C4	GND	D4	AD6
A5	GND	B5	AD9	C5	AD8	D5	GND
A6	AD11	B6	N.C	C6	AD10	D6	M66EN
A7	AD14	B7	AD13	C7	GND	D7	AD12
A8	+3.3V	B8	C/BE1#	C8	AD15	D8	+3.3V
A9	SERR#	B9	GND	C9	SB0#	D9	PAR
A10	GND	B10	PERR#	C10	+3.3V	D10	SDONE
A11	STOP*	B11	+3.3V	C11	LOCK#	D11	GND
A12	+3.3V	B12	TRDY#	C12	GND	D12	DEVSEL#
A13	FRAME#	B13	GND	C13	IRDY#	D13	+3.3V
A14	GND	B14	AD16	C14	+3.3V	D14	C/BE2#
A15	AD18	B15	+3.3V	C15	AD17	D15	GND
A16	AD21	B16	AD20	C16	GND	D16	AD19
A17	+3.3V	B17	AD23	C17	AD22	D17	+3.3V
A18	IDSEL0	B18	GND	C18	IDSEL1	D18	IDSEL2
A19	AD24	B19	C/BE3#	C19	N.C.	D19	IDSEL3
A20	GND	B20	AD26	C20	AD25	D20	GND
A21	AD29	B21	+5V	C21	AD28	D21	AD27
A22	+5V	B22	AD30	C22	GND	D22	AD31
A23	REQ0#	B23	GND	C23	REQ1#	D23	N.C.
A24	GND	B24	REQ2#	C24	+5V	D24	GNT0#
A25	GNT1#	B25	N.C	C25	GNT2#	D25	GND
A26	+5V	B26	CLK0	C26	GND	D26	CLK1
A27	CLK2	B27	+5V	C27	CLK3	D27	GND
A28	GND	B28	INTD#	C28	+5V	D28	RST#
A29	+12V	B29	INTA#	C29	INTB#	D29	INTC#
A30	-12V	B30	Reserved	C30	Reserved	D30	GND

3.17 PICMG compliant PCI-X Connector

The **3300020 Series** provides a free PICMG compliant PCI slot for 64-bit/66MHz PCI-X and backward compatible to 32-bit/33MHz PCI device extension.

PCI1: PICMG Slot Connector Pin Assignment

Pin	Signal	Pin	Signal
B1	-12V	A1	Reserved
B2	Reserved	A2	+12V
B3	GND	A3	Reserved
B4	Reserved	A4	Reserved
B5	+5V	A5	+5V
B6	+5V	A6	INTA#
B7	INTB#	A7	INTC#
B8	INTD#	A8	+5V
B9	REQ3#	A9	CLK_C
B10	REQ1#	A10	VIO
B11	GNT3#	A11	CLK_D
B12	GND	A12	GND
B13	GND	A13	GND
B14	CLK_A	A14	GNT1#
B15	GND	A15	RST#
B16	CLK_B	A16	VIO
B17	GND	A17	GNT0#
B18	REQ0#	A18	GND
B19	VIO	A19	REQ2#
B20	AD31	A20	AD30
B21	AD29	A21	+3.3V
B22	GND	A22	AD28
B23	AD27	A23	AD26
B24	AD25	A24	GND
B25	+3.3V	A25	AD24

Continued

Pin	Signal	Pin	Signal
B26	CBE3#	A26	IDSEL
B27	AD23	A27	+3.3V
B28	GND	A28	AD22
B29	AD21	A29	AD20
B30	AD19	A30	GND
B31	+3.3V	A31	AD18
B32	AD17	A32	AD16
B33	CBE2#	A33	+3.3V
B34	GND	A34	FRAME#
B35	IRDY#	A35	GND
B36	+3.3V	A36	TRDY#
B37	DEVSEL#	A37	GND
B38	PCIXCAP	A38	STOP#
B39	LOCK#	A39	+3.3V
B40	PERR#	A40	SDONE
B41	+3.3V	A41	SBO#
B42	SERR#	A42	GND
B43	+3.3V	A43	PAR
B44	CBE1#	A44	AD15
B45	AD14	A45	+3.3V
B46	GND	A46	AD13
B47	AD12	A47	AD11
B48	AD10	A48	GND
B49	M66EN	A49	AD09
B52	AD08	A52	CBE0#
B53	AD07	A53	+3.3V
B54	+3.3V	A54	AD06
B55	AD05	A55	AD04
B56	AD03	A56	GND
B57	GND	A57	AD02
B58	AD01	A58	AD0
B59	VIO	A59	VIO
B60	ACK64#	A60	REQ64#
B61	+5V	A61	+5V

Continued

Pin	Signal	Pin	Signal
B62	+5V	A62	+5V
B63	Reserved	A63	GND
B64	GND	A64	CBE7#
B65	CBE6#	A65	CBE5#
B66	CBE4#	A66	VIO
B67	GND	A67	PAR64
B68	AD63	A68	AD62
B69	AD61	A69	GND
B70	VIO	A70	AD60
B71	AD59	A71	AD58
B72	AD57	A72	GND
B73	GND	A73	AD56
B74	AD55	A74	AD54
B75	AD53	A75	VIO
B76	GND	A76	AD52
B77	AD51	A77	AD50
B78	AD49	A78	GND
B79	VIO	A79	AD48
B80	AD47	A80	AD46
B81	AD45	A81	GND
B82	GND	A82	AD44
B83	AD43	A83	AD42
B84	AD41	A84	VIO
B85	GND	A85	AD40
B86	AD39	A86	AD38
B87	AD37	A87	GND
B88	VIO	A88	AD36
B89	AD35	A89	AD34
B90	AD33	A90	GND
B91	GND	A91	AD32
B92	Reserved	A92	Reserved
B93	Reserved	A93	GND
B94	GND	A94	Reserved

J1: Mini-PCI Connector Pin Assignment

Pin	Signal	Pin	Signal
1	TIP	2	RING
	KEY		KEY
3	LAN_RD+	4	LAN_TD+
5	LAN_RD-	6	LAN_TD-
7	RJ45 termination	8	RJ45 termination
9	RJ45 termination	10	RJ45 termination
11	LAN_LED1+	12	LAN_LED2+
13	LAN_LED1-	14	LAN_LED2-
15	CHGND	16	RESERVED
17	INTB#	18	5V
19	3.3V	20	INTA#
21	RESERVED	22	RESERVED
23	GND	24	3.3VAUX
25	CLK	26	RST#
27	GND	28	3.3V
29	REQ#	30	GNT#
31	3.3V	32	GND
33	AD31	34	PME#
35	AD29	36	RESERVED
37	GND	38	AD30
39	AD27	40	3.3V
41	AD25	42	AD28
43	RESERVED	44	AD26
45	C/BE3#	46	AD24
47	AD23	48	IDSEL
49	GND	50	GND
51	AD21	52	AD22
53	AD19	54	AD20
55	GND	56	PAR
57	AD17	58	AD18
59	C/BE2#	60	AD16
61	IRDY#	62	GND

Continued

Pin	Signal	Pin	Signal
63	3.3V	64	FRAME#
65	CLKRUN#	66	TRDY#
67	SERR#	68	STOP#
69	GND	70	3.3V
71	PERR#	72	DEVSEL#
73	C/BE1#	74	GND
75	AD14	76	AD15
77	GND	78	AD13
79	AD12	80	AD11
81	AD10	82	GND
83	GND	84	AD09
85	AD08	86	C/BE0#
87	AD07	88	3.3V
89	3.3V	90	AD06
91	AD05	92	AD04
93	RESERVED	94	AD02
95	5V	96	AD00
97	5V	98	RESERVED
99	AD01	100	RESERVED
101	GND	102	GND
103	AC_SYNC	104	M66EN
105	AC_SDATA_IN	106	AC_SDATA_OUT
107	AC_BITCLK	108	AC_ID0
109	AC_ID1	110	AC_RST#
111	RESERVED	112	RESERVED
113	RESERVED	114	GND
115	RESERVED	116	RESERVED
117	RESERVED	118	RESERVED
119	RESERVED	120	RESERVED
121	RESERVED	122	RESERVED
123	RESERVED	124	RESERVED

3.18 Audio Connector

The **3300020VEA** supports audio interface. **CN5** is a 10pin-header connector commonly used for the audio.

Pin	Signal	Pin	Signal
1	MIC-IN	2	GND
3	Line In L	4	GND
5	Line In R	6	GND
7	Audio Out L	8	GND
9	Audio Out R	10	GND

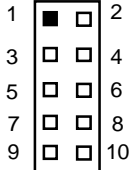

3.19 Compact Flash™ Socket (CN26)

The 3300020 Series is equipped with a Compact Flash disk type-II socket on the solder side and it supports the IDE interface Compact Flash disk card with DMA mode supported. The socket itself is especially designed to prevent any incorrect installation of the Compact Flash disk card.

When installing or removing the Compact Flash disk card, please make sure that the system power is off.

The Compact Flash disk card is defaulted as the C: or D: disk drive in your PC system.

CN26: Compact Flash Socket

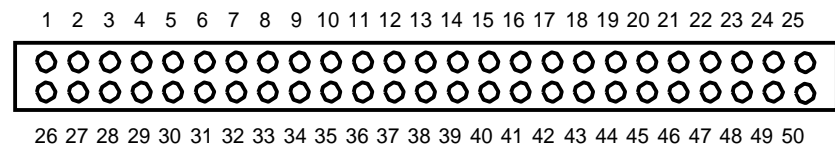

Pin	Description	Pin	Description
1	GND	26	CD1-
2	Data 3	27	Data 11
3	Data 4	28	Data 12
4	Data 5	29	Data 13
5	Data 6	30	Data 14
6	Data 7	31	Data 15
7	CS0#	32	CS1#
8	Address 10	33	VS1#
9	ATASEL	34	IORD#
10	Address 9	35	IOWR#
11	Address 8	36	WE#
12	Address 7	37	INTR
13	VCC	38	VCC
14	Address 6	39	CSEL#
15	Address 5	40	VS2#
16	Address 4	41	RESET#
17	Address 3	42	IORDY#
18	Address 2	43	DMAREQ
19	Address 1	44	DMAACK-
20	Address 0	45	DASP#
21	Data 0	46	PDIAG#
22	Data 1	47	Data 8
23	Data 2	48	Data 9
24	IOCS16#	49	Data 10
25	CD2#	50	GND

3.20 Pin Assignments of Other Connectors

CN1: Power Connector Pin Assignment

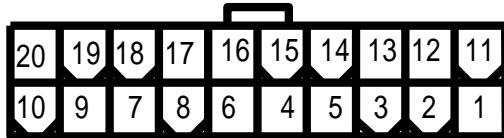

Pin	Description	Pin	Description
1	3.3V	2	3.3V
3	GND	4	5V
5	GND	6	5V
7	GND	8	PW_OK
9	5VSB	10	12V
11	3.3V	12	-12V
13	GND	14	PS_ON
15	GND	16	GND
17	GND	18	-5V
19	5V	20	5V

CN13: Flat Panel Bezel Connector

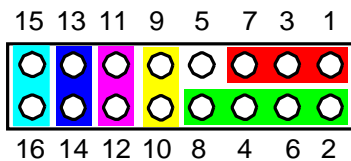

Power LED

This 3-pin connector, designated at **Pins 1** and **5** of **CN13**, connects the system power LED indicator to its respective switch on the case. **Pin 1** is +, and **pin 5** is assigned as -. The Power LED lights up when the system is powered ON.

External Speaker and Internal Buzzer Connector

Pins 2, 4, 6, and 8 of CN13 connect to the case-mounted speaker unit or internal buzzer. **Short pins 4-6** when connecting the CPU card to an internal buzzer. When connecting an external speaker, set these jumpers to **Open** and install the speaker cable on **pin 8 (+)** and **pin 2 (-)**.

ATX Power On/Off Button

This 2-pin connector, designated at **Pins 9 & 10 of CN13**, connects the ATX power button of the front panel to the **3300020** CPU card - allowing user to control the power on/off state of the ATX power supply.

System Reset Switch

Pins 11 & 12 of CN13 connect to the case-mounted reset switch and allow rebooting of your computer instead of turning OFF the power switch. This is a preferred method of rebooting in order to prolong the life of the system's power supply.

HDD Activity LED

This connector extends to the hard drive activity LED on the control panel. This LED will flash when the HDD is being accessed. **Pins 15 & 16 of CN13** connect the hard disk drive and the front panel HDD LED. **Pins 15** is -, and **pin 16** is assigned as +.

Keyboard Lock

Pins 13 and 14 of CN13 are Keyboard Lock setting. Short the **Pins 13 and 14** for Keyboard Lock.

CN22: IrDA Connector Pin Assignment

Pin	Description
1	VCC
2	HIRRX
3	IRRX
4	GND
5	IRTX

CN16: LAN LED Connector Pin Assignment

Pin	Signal	Pin	Signal
1	Active LED-	2	Active LED+
3	Link100 LED-	4	Link 100 LED+
5	Link10 LED-	6	Link 10 LED+
7	Link 1000 LED-	8	Link 1000 LED+

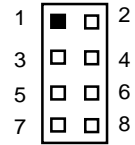

Chapter 4

Award BIOS Utility

The Phoenix-Award BIOS has a built-in Setup program that allows users to modify the basic system configuration. This type of information is stored in a battery-backed RAM (CMOS RAM) that retains the Setup information each time the power is turned off.

4.1 Entering Setup

There are two ways to enter the Setup program. You may either turn ON the computer and press immediately, or press the and/or <Ctrl>, <Alt>, and <Esc> keys simultaneously when the following message appears at the bottom of the screen during POST (Power on Self Test).

TO ENTER SETUP PRESS DEL KEY

If the message disappears before you respond and you still wish to enter Setup, restart the system and try again. This is possible by turning the system power to OFF then to ON, pressing the "RESET" button on the system case, or by simultaneously pressing <Ctrl>, <Alt>, and keys. If you do not press the keys at the correct time and the system does not boot, an error message will be displayed and you will be prompted with the following:

PRESS <F1> TO CONTINUE, <CTRL-ALT-ESC> OR TO ENTER
SETUP

4.2 Control Keys

Up arrow	Moves cursor to the previous item
Down arrow	Moves cursor to the next item
Left arrow	Moves cursor to the item on the left hand
Right arrow	Move to the item in the right hand
Esc key	Main Menu -- Quits and deletes changes into CMOS Status Page Setup Menu and Option Page Setup Menu -- Exits current page and returns to Main Menu
PgUp/"+" key	Increases the numeric value or makes changes
PgDn/"-" key	Decreases the numeric value or makes changes
F1 key	General help, only for Status Page Setup Menu and Option Page Setup Menu
(Shift) F2 key	Change color from total 16 colors. F2 to select color forward, (Shift) F2 to select color backward
F3 key	Reserved
F4 key	Reserved
F5 key	Restores the previous CMOS value from CMOS, only for Option Page Setup Menu
F6 key	Loads the default CMOS value from BIOS default table, only for Option Page Setup Menu
F7 key	Loads the Setup default, only for Option Page Setup Menu
F8 key	Reserved
F9 key	Reserved
F10 key	Saves all the CMOS changes, only for Main Menu

4.3 Getting Help

- z Main Menu
The on-line description of the highlighted setup function is displayed at the bottom of the screen.
- z Status Page Setup Menu/Option Page Setup Menu
Press <F1> to pop up a small help window that describes the appropriate keys to use and the possible selections for the highlighted item. To exit the Help Window press <F1> or <Esc>.

4.4 The Main Menu

Once you enter the Award BIOS CMOS Setup Utility, the Main Menu will appear on the screen. The Main Menu allows you to select from ten setup functions and two exit choices. Use the arrow keys to select the setup function you intend to configure then press <Enter> to accept or enter its sub-menu.

CMOS Setup Utility-Copyright © 2000-2004 Award Software

▶ Standard CMOS Features	▶ Frequency/Voltage Control
▶ Advanced BIOS Features	Load Fail-Safe Defaults
▶ Advanced Chipset Features	Load Optimized Defaults
▶ Integrated Peripherals	Set Supervisor Password
▶ Power Management Setup	Set User Password
▶ PnP/PCI Configurations	Save & Exit Setup
▶ PC Health Status	Exit Without Saving
Esc : Quit F9: Menu in BIOS Ç È Æ Å : Select Item	
F10 : Save & Exit Setup	
F6 : SAVE CMOS TO BIOS F7: LOAD CMOS FROM BIOS	
Time, Date, Hard Disk Type...	

NOTE: *If you find that your computer cannot boot after making and saving system changes with Setup, the Award BIOS, via its built-in override feature, resets your system to the CMOS default settings.*

We strongly recommend that you avoid making any changes to the chipset defaults. These defaults have been carefully chosen by both Award and your system manufacturer to provide the absolute maximum performance and reliability.

4.5 Standard CMOS Setup Menu

The items in Standard CMOS Setup Menu are divided into 10 categories. Each category includes no, one or more than one setup items. Use the arrow keys to highlight the item and then use the <PgUp> or <PgDn> keys to select the value you want in each item.

CMOS Setup Utility-Copyright © 2000-2004 Award Software Standard CMOS Features

Date (mm:dd:yy)	Thu, Jan 10 2002	Item Help
Time (hh:mm:ss)	2 : 31 : 24	Menu Level F
F IDE Primary Master		Change the Day, month, Year and Century
F IDE Primary Slave		
F IDE Secondary Master		
F IDE Secondary Slave		
Drive A	1.44M, 3.5 in.	
Drive B	None	
Video	EGA/VGA	
Halt On	All, But Keyboard	
ÇÈÆÅ : Move Enter: Select +/-/PU/PD: Value F10: Save ESC: Exit F1: General Help F5: Previous Values F6: Fail-Safe Defaults F7: Optimized Defaults		

z Date

The date format is <day>, <date> <month> <year>. Press <F3> to show the calendar.

day	The day of week, from Sun to Sat, determined by the BIOS, is read only
date	The date, from 1 to 31 (or the maximum allowed in the month), can key in the numerical / function key
month	The month, Jan through Dec.
year	The year, depends on the year of BIOS

z Time

The time format is <hour> <minute> <second> accepting either functions key or numerical key. The time is calculated based on the 24-hour military-time clock. For example, 1 p.m. is 13:00:00.

z Primary Master/Primary Slave/Secondary Master/Secondary Slave

The categories identify the types of one channel that have been installed in the computer. There are 45 predefined types and 2 users definable types are for Enhanced IDE BIOS. Type 1 to Type 45 is predefined. Type User is user-definable.

Press <PgUp>/<+> or <PgDn>/<-> to select a numbered hard disk type or type the number and press <Enter>. Note that the specifications of your drive must match with the drive table. The hard disk will not work properly if you enter improper information within this category. If your hard disk drive type does not match or is not listed, you can use Type User to define your own drive type manually.

If you select Type User, related information is asked to be entered to the following items. Enter the information directly from the keyboard and press <Enter>. This information should be provided in the documentation from your hard disk vendor or the system manufacturer.

If the controller of HDD interface is ESDI, select "Type 1".

If the controller of HDD interface is SCSI, select "None".

If the controller of HDD interface is CD-ROM, select "None".

CYLS.	number of cylinders	LANDZONE	landing zone
HEADS	number of heads	SECTORS	number of sectors
PRECOMP	write precom	MODE	HDD access mode

If there is no hard disk drive installed, select NONE and press <Enter>.

z Drive A type/Drive B type

The category identifies the types of floppy disk drive A or drive B installed in the computer.

None	No floppy drive installed
360K, 5.25 in	5.25 inch PC-type standard drive; 360Kb capacity
1.2M, 5.25 in	5.25 inch AT-type high-density drive; 1.2MB capacity
720K, 3.5 in	3.5 inch double-sided drive; 720Kb capacity
1.44M, 3.5 in	3.5 inch double-sided drive; 1.44MB capacity
2.88M, 3.5 in	3.5 inch double-sided drive; 2.88MB capacity

z Halt On

This field determines whether the system will halt if an error is detected during power up.

No errors	The system boot will halt on any error detected. (default)
All errors	Whenever the BIOS detect a non-fatal error, the system will stop and you will be prompted.
All, But Keyboard	The system boot will not stop for a keyboard error; it will stop for all other errors.
All, But Diskette	The system boot will not stop for a disk error; it will stop for all other errors.
All, But Disk/Key	The system boot will not stop for a keyboard or disk error; it will stop for all other errors.

4.6 Advanced BIOS Features

This section allows you to configure and improve your system and allows you to set up some system features according to your preference.

CMOS Setup Utility-Copyright © 2000-2004 Award Software Advanced BIOS Features

CPU Feature	Press Enter	Item Help
Hard Disk Boot Priority	Press Enter	
Virus Warning	Disabled	Menu Level F
CPU L1 & L2 Cache	Enabled	
CPU L2 Cache	Enabled	
Quick Power On Self Test	Enabled	
First Boot Device	HDD-0	
Second Boot Device	Floppy	
Third Boot Device	SCSI	
Boot Other Device	Enabled	
Swap Floppy Drive	Disabled	
Boot Up Floppy Seek	Enabled	
Boot Up NumLock Status	On	
Gate A20 Option	Fast	
Typematic Rate Setting	Disabled	
Typematic Rate (Chars/Sec)	6	
Typematic Delay (Msec)	250	
Security Option	Setup	
APIC Mode	Enabled	
PS/2 Mouse Function Control	Enabled	
OS Select for DRAM >64MB	Non-OS2	
Report No FDD For WIN 95	No	
Full Screen Logo Show	Disabled	
Small Screen Show	Disabled	
Summary Screen Show	Enabled	
Display board ID	Disabled	
␣␣␣␣␣ : Move Enter: Select +/-/PU/PD: Value F10: Save ESC: Exit F1: General Help F5: Previous Values F6: Fail-Safe Defaults F7: Optimized Defaults		

- z Hard Disk Boot Priority
This item can select boot device priority.

- z Virus Warning
This option flashes on the screen. During and after the system boot up, any attempt to write to the boot sector or partition table of the hard disk drive will halt the system with the following message. You can run an anti-virus program to locate the problem. The default setting is “Disabled”.

! WARNING !
Disk boot sector is to be modified
 Type “Y” to accept write or “N” to abort write
 Award Software, Inc.

Enabled	Activates automatically when the system boots up causing a warning message to appear when there is an attempt to access the boot sector or hard disk partition table.
Disabled	No warning message will appear when attempts to access the boot sector or hard disk partition table are made.

NOTE: *This function is only available with DOS and other operating systems that do not trap INT13.*

- z CPU L1 & L2 Cache
These two options speed up memory access. However, it depends on the CPU/chipset design. The default setting is “Enabled”. CPUs with no built-in internal cache will not provide the “CPU Internal Cache” item on the menu.

Enabled	Enable cache
Disabled	Disable cache

- z Quick Power On Self Test
This option speeds up Power on Self Test (POST) after you turn on the system power. If set as Enabled, BIOS will shorten or skip some check items during POST. The default setting is “Enabled”.

Enabled	Enable Quick POST
Disabled	Normal POST

- z First/Second/Third Boot Device
These items allow the selection of the 1st, 2nd, and 3rd devices that the system will search for during its boot-up sequence. The wide range of selection includes Floppy, LS120, ZIP100, HDD0~3, SCSI, and CDROM.
- z Boot Other Device
This item allows the user to enable/disable the boot device not listed on the First/Second/Third boot devices option above. The default setting is **Enabled**.
- z Swap Floppy Drive
This allows you to determine whether to enable Swap Floppy Drive or not. When enabled, the BIOS swap floppy drive assignments so that Drive A becomes Drive B, and Drive B become Drive A. By default, this field is set to *Disabled*.
- z Boot Up Floppy Seek
During POST, BIOS will determine the floppy disk drive type, 40 or 80 tracks, installed in the system. 360Kb type is 40 tracks while 720Kb, 1.2MB and 1.44MB are all 80 tracks. The default value is "Enabled".

Enabled	BIOS searches for floppy disk drive to determine if it is 40 or 80 tracks. Note that BIOS can not tell from 720K, 1.2M or 1.44M drives type as they are all 80 tracks.
Disabled	BIOS will not search for the type of floppy disk drive by track number. There will be no warning message displayed if the drive installed is 360K.

z

z Boot Up NumLock Status

This option enables and disables the number lock function of the keypad. The default value is "On".

On	Keypad functions confine with numbers
Off	Keypad functions convert to special functions (i.e., left/right arrow keys)

z Gate A20 Option

The default value is "Fast".

Normal	The A20 signal is controlled by keyboard controller or chipset hardware.
Fast	Default: Fast. The A20 signal is controlled by Port 92 or chipset specific method.

z Typematic Rate Setting

This determines the typematic rate of the keyboard. The default value is "Disabled".

Enabled	Enable typematic rate and typematic delay programming
Disabled	Disable typematic rate and typematic delay programming. The system BIOS will use default value of these 2 items and the default is controlled by keyboard.

z Typematic Rate (Chars/Sec)

This option refers to the number of characters the keyboard can type per second. The default value is "6".

6	6 characters per second
8	8 characters per second
10	10 characters per second
12	12 characters per second
15	15 characters per second
20	20 characters per second
24	24 characters per second
30	30 characters per second

z Typematic Delay (Msec)

This option sets the display time interval from the first to the second character when holding a key. The default value is "250".

250	250 msec
500	500 msec
750	750 msec
1000	1000 msec

z Security Option

This item allows you to limit access to the system and Setup, or just to Setup. The default value is "Setup".

System	The system will not boot and access to Setup will be denied if the incorrect password is entered at the prompt.
Setup	The system will boot, but access to Setup will be denied if the correct password is not entered at the prompt.

NOTE: *To disable security, select PASSWORD SETTING at Main Menu and then you will be asked to enter password. Do not type anything, just press <Enter> and it will disable security. Once the security is disabled, the system will boot and you can enter Setup freely.*

z OS Select for DRAM >64MB

This segment is specifically created for OS/2 when DRAM is larger than 64MB. If your operating system is OS/2 and DRAM used is larger the 64MB, you have to select "OS 2", otherwise (under non-OS2), default is NON-OS2. The default value is "Non-OS2".

z Report No FDD For Win 95

This option allows Windows 95 to share IRQ6 (assigned to a floppy disk drive) with other peripherals in case the drive does not exist. The default setting is "No".

4.7 Advanced Chipset Features

Since the features in this section are related to the chipset on the CPU board and are completely optimized, you are not recommended to change the default settings in this setup table unless you are well oriented with the chipset features.

CMOS Setup Utility-Copyright © 1984-2001 Award Software Advanced Chipset Features

		Item Help
DRAM Timing	By SPD	
CASs Latency Time	2.5	
Active to Recharge Delay	7	Menu Level f
DRAM RAS# to CAS# Delay	3	
DRAM RAS# Recharge	3	
DRAM Data Integrity Mode	Non-ECC	
MGM Core Frequency	Auto Max 400/333MHz	
System BIOS Cacheable	Enable	
Video BIOS Cacheable	Disabled	
Memory Hole At 15M-16M	Disabled	
Delayed Transaction	Disabled	
Delay Prior to Thermal	16 Min	
AGP Aperture Size (MB)	64	
Init Display First	Onboard	
** On-Chip VGA Setting **		
On-Chip VGA	Enabled	
On-Chip Frame Buffer Size	32MB	
Boot Display	Auto	
Panel Scaling	Auto	
Panel Number	640 x480	
⌂ Æ Å : Move Enter: Select +/-/PU/PD: Value F10: Save ESC: Exit F1: General Help F5: Previous Values F6: Fail-Safe Defaults F7: Optimized Defaults		

- z SDRAM CAS latency Time
You can select CAS latency time in HCLKs 2, 3, or Auto. The board designer should set the values in this field, depending on the DRAM installed. Do not change the values in this field unless you change specifications of the installed DRAM or the installed CPU.
- z DRAM Data Integrity Mode
This option sets the data integrity mode of the DRAM installed in the system. The default setting is "Non-ECC".

- z System BIOS Cacheable
Selecting Enabled allows caching of the system BIOS ROM at F0000h-FFFFFh, resulting in better system performance. However, if any program writes to this memory area, a system error may result. The default value is *“Disabled”*.
- z Video BIOS Cacheable
This item allows you to change the Video BIOS location from ROM to RAM. Video Shadow will increase the video speed.
- z Video RAM Cacheable
Selecting Enabled allows caching of the video BIOS ROM at C0000h to C7FFFh, resulting in better video performance. However, if any program writes to this memory area, a system error may result. The default value is *“Disabled”*.
- z Memory Hole at 15M-16M
You can reserve this area of system memory for ISA adapter ROM. When this area is reserved, it cannot be cached. The user information of peripherals that need to use this area of system memory usually discusses their memory requirements. The default value is *“Disabled”*.
- z Delayed Transaction
The chipset has an embedded 32-bit posted write buffer to support delay transactions cycles. Select *Enabled* to support compliance with PCI specification version 2.1. The options available are *Enabled* and *Disabled*.
- z AGP Aperture Size (MB)
The field sets aperture size of the graphics. The aperture is a portion of the PCI memory address range dedicated for graphics memory address space. Host cycles that hit the aperture range are forwarded to the AGP without any translation. The options available are 4M, 8M, 16M, 32M, 64M, 128M and 256M.

4.8 Integrated Peripherals

This option sets your hard disk configuration, mode and port.

CMOS Setup Utility-Copyright © 1984-2001 Award Software Integrated Peripherals

▶ On Chip IDE Device	Press Enter	
▶ On Board Device	Press Enter	Menu Level f
▶ Superior Device	Press Enter	
Onboard LAN boot ROM	Disable	
ÇÈÆÅ : Move Enter: Select +/-/PU/PD: Value F10: Save ESC: Exit F1: General Help F5: Previous Values F6: Fail-Safe Defaults F7: Optimized Defaults		

CMOS Setup Utility-Copyright © 1984-2001 Award Software On Chip IDE Device

IDE DMA transfer Access	Enabled	
On-Chip Primary PCI IDE	Enabled	Menu Level f
IDE Primary Master PIO	Auto	
IDE Primary Master PIO	Auto	
IDE Primary Master UDMA	Auto	
IDE Primary Master UDMA	Auto	
On-Chip Primary PCI IDE	Enabled	
IDE Secondary Master PIO	Auto	
IDE Secondary Master PIO	Auto	
IDE Secondary Master PIO	Auto	
IDE Secondary Master PIO	Auto	
** On-Chip Serial ATA Setting **		
SATA Mode	IDE	
On-Chip Serial ATA	Auto	
Serial ATA Port0	Primary Master	
Serial ATA Port1	Primary Master	
IDE HDD Block Mode	Enabled	
ÇÈÆÅ : Move Enter: Select +/-/PU/PD: Value F10: Save ESC: Exit F1: General Help F5: Previous Values F6: Fail-Safe Defaults F7: Optimized Defaults		

**CMOS Setup Utility-Copyright © 1984-2001 Award Software
On board Device**

USB Controller	Enable	
USB 2.0 Controller	Enabled	Menu Level f
USB Keyboard Support	Disabled	
USB Mouse Support	Disabled	
AC97 Audio	Auto	
Hance Rapid Watchdog	0	
ÇÈÆÅ : Move Enter: Select +/-/PU/PD: Value F10: Save ESC: Exit F1: General Help F5: Previous Values F6: Fail-Safe Defaults F7: Optimized Defaults BIOS		

**Setup Utility-Copyright © 1984-2001 Award Software Super
IO Device**

Onboard FDC Controller	Enabled	
Onboard Serial Port 1	3F8/IRQ4	Menu Level f
Onboard Serial Port 1	2F8/IRQ3	
UART Mode Select	Normal	
Red, TxD Active	Hi,Lo	
IR Transmission Delay	Enabled	
UR2 Duplex Mode	Half	
Use IR Pins	IR-Rx2Tx2	
Onboard Parallel Port	378/IRQ7	
Parallel Port Mode	SPP	
EPP Mode Select	EEP1.7	
ECP Mode Use DMA	3	
ICH Serial Port 1	3E8	
ICH Serial Port 1 Use IRQ	IRQ10	
ICH Serial Port 2	2E8	
ICH Serial Port 2 Use IRQ	IRQ11	
PWRON after power fail	OFF	
ÇÈÆÅ : Move Enter: Select +/-/PU/PD: Value F10: Save ESC: Exit F1: General Help F5: Previous Values F6: Fail-Safe Defaults F7: Optimized Defaults		

- z IDE Primary/Secondary Master/Slave PIO**
 The four IDE PIO (Programmed Input/Output) fields let you set a PIO mode (0-4) for each of the four IDE devices that the onboard IDE interface supports. Modes 0 through 4 provide successively increased performance. In Auto mode, the system automatically determines the best mode for each device. The options available are Auto, Mode 0, Mode 1, Mode 2, Mode 3, and Mode 4.

- z IDE Primary/Secondary Master/Slave UDMA
Ultra DMA 66/100 implementation is possible only if your IDE hard drive supports it and the operating environment includes a DMA driver (Windows 95 OSR2 or a third-party IDE bus master driver). If your hard drive and your system software support Ultra DMA 33/66/100, select Auto to enable BIOS support. The options available are Auto, Mode 0, Mode 1, and Mode 2.
- z On-Chip Primary/Secondary PCI IDE
The integrated peripheral controller contains an IDE interface with support for two IDE channels. Select Enabled to activate each channel separately. The default value is "Enabled".
NOTE: *Choosing Disabled for these options will automatically remove the IDE Primary Master/Slave PIO and/or IDE Secondary Master/Slave PIO items on the menu.*
- z USB Keyboard Support
Select *Enabled* if your system contains a Universal Serial Bus (USB) controller and you have a USB keyboard.
- z Init Display First
This item allows you to decide to active whether PCI Slot or AGP first. The options available are PCI Slot, AGP.
- z IDE HDD Block Mode
This field allows your hard disk controller to use the fast block mode to transfer data to and from your hard disk drive.
- z POWER ON Function
This option allows users to select the type of power ON sequence for the system to follow. The default value is "Button-Only".

BUTTON-ONLY	Follows the conventional way of turning OFF system power (via power button).
Password	Upon selecting this option, the KB POWER ON Password line appears. Press <Enter> and you'll be prompted to enter and confirm a password of your choice. After setting the password, succeeding attempts to power ON the system will result to null. For system to activate, user must input the password via keyboard then press <Enter>.
Hot KEY	This option is very similar with that of Password. Hot-key combinations range from Ctrl-F1 to Ctrl-F12. User may define this combination from the Hot key Power ON option.

- z Onboard FDC Controller
Select Enabled if your system has a floppy disk controller (FDC) installed on the system board and you wish to use it. If you install and-in FDC or the system has no floppy drive, select Disabled in this field. The options available are Enabled, Disabled.
- z Onboard Serial Port 1/Port 2
Select an address and corresponding interrupt for the first and second serial ports. The options available are 3F8/IRQ4, 2E8/IRQ3, 3E8/IRQ4, 2F8/IRQ3, Disabled, Auto.
- z UART2 Duplex Mode
The second serial port offers these infrared interface modes:
 - ¾ IrDA
 - ¾ ASKIR IrDA-compliant serial infrared port
 - ¾ Normal (default value)

NOTE: *The UART Mode Select will not appear on the menu once you disable the setting of Onboard Serial Port 2.*

When UART Mode Select is set as ASKIR or IrDA, the options RxD, TxD Active and IR Transmission delay will appear.

- z Parallel Port Mode
Select an operating mode for the onboard parallel (printer) port. Select Normal unless your hardware and software require one of the other modes offered in this field. The options available are EPP1.9, ECP, SPP, ECPEPP1.7, and EPP1.7.
- z ECP Mode Use DMA
Select a DMA channel for the parallel port for use during ECP mode.

4.9 Power Management Setup

The Power Management Setup allows you to save energy of your system effectively. It will shut down the hard disk and turn OFF video display after a period of inactivity.

CMOS Setup Utility-Copyright © 1984-2001 Award Software
Power Management Setup

ACPI function	Enabled	Item Help
ACPI Suspend Type	S1(POS)	
Power Management	Min Saving	
PM Control by APM	Yes	Menu Level F
Video Off Method	V/H SYNC+Blank	
Video off After	Standby	
MODEM Use IRQ	3	
Suspend Mode	1 Hour	
HDD Power Down	15 Min	
Soft-Off by PWR-BTTN	Instant-Off	
CPU THRM-Throttling	50.0%	
Wake-up by PCI card	Enabled	
PowerOn by Ring	Enabled	
Wake UP On LAN	Enabled	
USB KB Wake-Up From S3	Disabled	
Resume by Alarm	Disabled	
Date (of Month) Alarm	0	
Time (hh:mm:ss) Alarm	0:0:0	
** Reload Global Timer Events **		
Primary IDE 0	Disabled	
Primary IDE 1	Disabled	
Secondary IDE 0	Disabled	
Secondary IDE 1	Disabled	
FDD,COM,LPT Port	Disabled	
PCI PIRQ[A-D]#	Disabled	
ÇÈÆÅ : Move Enter: Select +/-/PU/PD: Value F10: Save ESC: Exit F1: General Help F5: Previous Values F6: Fail-Safe Defaults F7: Optimized Defaults		

z ACPI Function
 This item allows you to enable/disable the Advanced Configuration and Power Management (ACPI). The options available are Enabled, Disabled.

z Power Management
 This option allows you to select the type (or degree) of power saving for Doze, Standby, and Suspend modes. The table below describes each power management mode:

Max Saving	Maximum power savings. Only Available for SL CPUs. Inactivity period is 1 minute in each mode.
User Define	Sets each mode individually. Select time-out periods in the PM Timers section, following.
Min Saving	Minimum power savings. Inactivity period is 1 hour in each mode (except the hard drive).
Disabled	Default value

z PM Control by APM
 If Advanced Power Management (APM) is installed on your system, selecting Yes gives better power savings. The default value is "Yes".

No	System BIOS will ignore APM when power managing the system
Yes	System BIOS will wait for APM's prompt before it enters any PM mode (i.e., DOZE, STANDBY or SUSPEND). Note: If APM is installed or if there is a task running, even when the timer has timed out, the APM will not prompt the BIOS to put the system into any power saving mode!

NOTE: *If APM is not installed, this option has no effect.*

z Video Off Method

Determines the manner in which the monitor is blanked.

V/H SYNC+Blank	Turns OFF vertical and horizontal synchronization ports and writes blanks to the video buffer
DPMS	Select this option if your monitor supports the Display Power Management Signaling (DPMS) standard of the Video Electronics Standards Association (VESA). Use the software supplied for your video subsystem to select video power management values.
Blank Screen	System only writes blanks to the video buffer.

z Video Off After

As the system moves from lesser to greater power-saving modes, select the mode in which you want the monitor to blank off. The default value is "Standby".

NA	System BIOS will never turn off the screen
Suspend	Screen off when system is in SUSPEND mode
Standby	Screen off when system is in STANDBY mode
Doze	Screen off when system is in DOZE mode

NOTE: *Green monitors detect the V/H SYNC signals to turn off its electron gun*

z Modem Use IRQ

3, 4, 5, 7, 9, 10, 11, NA	For external modem, 3 or 4 will be used for card type modem. It is up to card definition. Default is 3.
---------------------------------	---

z Doze Mode

After the selected period of system inactivity (1 minute to 1 hour), the CPU clock runs at slower speed while all other devices still operate at full speed. The default value is "Disabled".

Disabled	System will never enter doze mode
1/2/4/6/8/10/20/30/ 40 Min/1 Hr	Defines the continuous idle time before the system entering DOZE mode.

z Standby Mode

After the selected period of system inactivity (1 minute to 1 hour), the fixed disk drive and the video shut off while all other devices still operate at full speed. The default value is "Disabled".

Disabled	System will never enter STANDBY mode
1/2/4/6/8/10/20/30/40 Min/1 Hr	Defines the continuous idle time before the system entering STANDBY mode. If any item defined in (J) is enabled & active, STANDBY timer will be reloaded

z Suspend Mode

After the selected period of system inactivity (1 minute to 1 hour), all devices except the CPU shut off. The default value is "Disabled".

Disabled	System will never enter SUSPEND mode
1/2/4/6/8/10/20/30/40 Min/1 Hr	Defines the continuous idle time before the system entering SUSPEND mode. If any item defined in (J) is enabled & active, SUSPEND timer will be reloaded

z HDD Power Down

After the selected period of drive inactivity (1 to 15 minutes), the hard disk drive powers down while all other devices remain active. The default value is "Disabled".

Disabled	HDD's motor will not power OFF.
1/2/3/4/5/6/7/8/9/10/11/12/13/14/15 Min	Defines the continuous HDD idle time before the HDD enters power saving mode (motor OFF)

z Throttle Duty Cycle

When the system enters Doze mode, the CPU clock runs only part of the time. You may select the percent of time that the clock runs. The default value is "62.5%".

z VGA Active Monitor

When Enabled, any video activity restarts the global timer for Standby mode. The default value is "Enabled".

- z Soft-Off by PWR-BTTN
This option only works with systems using an ATX power supply. It also allows the user to define which type of soft power OFF sequence the system will follow. The default value is "*Instant-Off*".

Instant-Off	This option follows the conventional manner systems perform when power is turned OFF. Instant-Off is a soft power OFF sequence requiring only the switching of the power supply button to OFF
Delay 4 Sec.	Upon turning OFF system from the power switch, this option will delay the complete system power OFF sequence by approximately 4 seconds. Within this delay period, system will temporarily enter into Suspend Mode enabling you to restart the system at once.

- z Power On by Ring
This option allows the system to resume or wake up upon detecting any ring signals coming from an installed modem. The default value is "*Enabled*".
- z IRQ 8 Break Suspend
You can turn on or off monitoring of IRQ8 (the Real Time Clock) so it does not awaken the system from Suspend mode. The default value is "*Disabled*".
- z Reload Global Timer Events
When *Enabled*, an event occurring on each device listed below restarts the global time for Standby mode.

4.10 PnP/PCI Configuration Setup

This section describes configuring the PCI bus system. PCI, or Personal Computer Interconnect, is a system which allows I/O devices to operate at speeds nearing the speed the CPU itself uses when communicating with its own special components. This section covers some very technical items and it is strongly recommended that only experienced users should make any changes to the default settings.

CMOS Setup Utility-Copyright © 1984-2001 Award Software PnP/PCI Configurations

Reset Configuration Data	Disabled	Item Help
Resources Controlled By ▶ IRQ Resources	Auto (ESCD) Press Enter	Menu Level f Select Yes if you are using a Plug and play capable operating system select No if you need the BIOS to configure non-boot devices
PCI/VGA Palette Snoop	Disabled	
⤴⤵⤶⤷ : Move Enter: Select +/-/PU/PD: Value F10: Save ESC: Exit F1: General Help F5: Previous Values F6: Fail-Safe Defaults F7: Optimized Defaults		

- z PNP OS Installed
Select Yes if the system operating environment is Plug-and-Play aware (e.g., Windows 95). The default value is "No".
- z Reset Configuration Data
Normally, you leave this field Disabled. Select Enabled to reset Extended System Configuration Data (ESCD) when you exit Setup or if you have installed a new add-on and the system reconfiguration has caused such a serious conflict that the operating system can not boot. The options available are Enabled and Disabled.

z Resources Controlled By

The Award Plug and Play BIOS can automatically configure all the boot and Plug and Play-compatible devices. If you select Auto, all the interrupt request (IRQ), DMA assignment, and Used DMA fields disappear, as the BIOS automatically assigns them. The default value is *“Manual”*.

z IRQ Resources

When resources are controlled manually, assign each system interrupt as one of the following types, depending on the type of device using the interrupt:

1. Legacy ISA Devices compliant with the original PC AT bus specification, requiring a specific interrupt (such as IRQ4 for serial port 1).
2. PCI/ISA PnP Devices compliant with the Plug and Play standard, whether designed for PCI or ISA bus architecture.

The default value is *“PCI/ISA PnP”*.

z DMA Resources

When resources are controlled manually, assign each system DMA channel as one of the following types, depending on the type of device using the interrupt:

1. Legacy ISA Devices compliant with the original PC AT bus specification, requiring a specific DMA channel.
2. PCI/ISA PnP Devices compliant with the Plug and Play standard, whether designed for PCI or ISA bus architecture.

The default value is *“PCI/ISA PnP”*.

z Memory Resources

This sub menu can let you control the memory resource.

z PCI/VGA Palette Snoop

Some non-standard VGA display cards may not show colors properly. This field allows you to set whether MPEG ISA/VESA VGA Cards can work with PCI/VGA or not. When enabled, a PCI/VGA can work with a MPEG ISA/VESA VGA card. When disabled, a PCI/VGA cannot work with a MPEG ISA/VESA Card.

- z Assign IRQ For USB/VGA
Enable/Disable to assign IRQ for USB/VGA.

4.11 PC Health Status

This option configures the PCI bus system. All PCI bus systems on the system use INT#, thus all installed PCI cards must be set to this value.

CMOS Setup Utility-Copyright © 1984-2001 Award Software
PC Health Status

CPU Warning Temperature	Disabled	Item Help
Current GMCH Temperature		Menu Level F
Current CPU Temp.		
Current System Temp.		
Current FAN1 Speed		
Current FAN2 Speed		
Vcore		
VTT		
+3.3V		
+5V		
+12V		
-12V		
-5V		
VBAT (V)		
5VSB (V)		
Shutdown Temperature	Disabled	
<p>␣␣␣␣ : Move Enter: Select +/-/PU/PD: Value F10: Save ESC: Exit F1: General Help F5: Previous Values F6: Fail-Safe Defaults F7: Optimized Defaults</p>		

- z Current CPU Temperature
These read-only fields reflect the functions of the hardware thermal sensor that monitors the chip blocks and system temperatures to ensure the system is stable.
- z Current FAN1/FAN2 Speed
These optional and read-only fields show the current speeds in RPM (revolution per minute) for the CPU fan and chassis fan as monitored by the hardware monitoring IC.

4.12 Frequency/Voltage Control

This option configures the PCI bus system. All PCI bus systems on the system use INT#, thus all installed PCI cards must be set to this value.

CMOS Setup Utility-Copyright © 1984-2001 Award Software Frequency/Voltage Control

Auto Detect DIMM/PCI Clk	Enabled	Item Help
Spread Spectrum	[Disabled]	Menu Level F
ÇÈÆÅ : Move Enter: Select +/-/PU/PD: Value F10: Save ESC: Exit F1: General Help F5: Previous Values F6: Fail-Safe Defaults F7: Optimized Defaults		

- z Auto Detect DIMM/PCI Clk
This item automatically detects the clock speeds of the system memory installed as well as the PCI interface. The options available are Enabled and Disabled. The default setting is **Enabled**.
- z Speed Spectrum
This item directly relates to the EMI performance of the whole system. When enabled, all system clocks run at slower speeds thereby decreasing the electromagnetic interference to the surrounding environment. Disabling this item improves the system performance but simultaneously increase the EMI. The default setting is **Disabled**.

4.13 Load Fail-Safe Defaults

This option allows you to load the troubleshooting default values permanently stored in the BIOS ROM. These default settings are non-optimal and disable all high-performance features.

CMOS Setup Utility-Copyright © Award Software

<ul style="list-style-type: none"> ▾ Standard CMOS Features ▾ Advanced BIOS Features ▾ Advanced Chipset Features ▾ Integrated Peripherals ▾ Power Ma ▾ PnP/PCI C ▾ PC Health Status 	<ul style="list-style-type: none"> ▾ Frequency/Voltage Control Load Fail-Safe Defaults Load Optimized Defaults Set Supervisor Password
<div style="border: 1px solid black; background-color: black; color: white; padding: 5px; display: inline-block;"> Load Fail-Safe Defaults (Y/N)? N </div>	
Exit Without Saving	
Esc : Quit	
F10 : Save & Exit Setup	
Ç È Æ Å : Select Item	
Load Fail-Safe Defaults	

To load BIOS defaults value to CMOS SRAM, enter “Y”. If not, enter “N”.

4.14 Load Optimized Defaults

This option allows you to load the default values to your system configuration. These default settings are optimal and enable all high performance features.

CMOS Setup Utility-Copyright © Award Software

Standard CMOS Features	Frequency/Voltage Control
Advanced BIOS Features	Load Fail-Safe Defaults
Advanced Chipset Features	Load Optimized Defaults
Integrated Peripherals	Set Supervisor Password
Power Man	Load Optimized Defaults (Y/N)? N
PnP/PCI Co	
PC Health Status	Exit Without Saving
Esc : Quit	Ç È Æ Å : Select Item
F10 : Save & Exit Setup	
Load Optimized Defaults	

To load SETUP defaults value to CMOS SRAM, enter “Y”. If not, enter “N”.

4.15 Set Supervisor/User Password

You can set either supervisor or user password, or both of them. The differences between are:

1. Supervisor password: can enter and change the options of the setup menus.
2. User password: just can enter but do not have the right to change the options of the setup menus.

When you select this function, the following message will appear at the center of the screen to assist you in creating a password.

ENTER PASSWORD:

Type the password with eight characters at most, and press <Enter>. The password typed will now clear any previously entered password from CMOS memory. You will be asked to confirm the password. Type the password again and press <Enter>. You may also press <Esc> to abort the selection and not enter a password.

To disable password, just press <Enter> when you are prompted to enter password. A message will confirm the password being disabled. Once the password is disabled, the system will boot and you can enter Setup freely.

PASSWORD DISABLED.

When a password is enabled, you have to type it every time you enter Setup. This prevents any unauthorized person from changing your system configuration.

Additionally when a password is enabled, you can also require the BIOS to request a password every time the system reboots. This would prevent unauthorized use of your computer.

You determine when the password is required within the BIOS Features Setup Menu and its Security option. If the Security option is set to "System", the password is required during boot up and entry into Setup. If set as "Setup", prompting will only occur prior to entering Setup.

4.16 Save & Exit Setup

This allows you to determine whether or not to accept the modifications. Typing “Y” quits the setup utility and saves all changes into the CMOS memory. Typing “N” brings you back to Setup utility.

CMOS Setup Utility-Copyright © Award Software	
· Standard CMOS Features	· Frequency/Voltage Control
· Advanced BIOS Features	Load Fail-Safe Defaults
· Advanced Chipset Features	Load Optimized Defaults
· Integrated Peripherals	Set Supervisor Password
· Power Man	SAVE to CMOS and EXIT (Y/N)? Y
· PnP/PCI Con	
· PC Health Status	Exit Without Saving
Esc : Quit	Ç È Æ Å : Select Item
F10 : Save & Exit Setup	
Save Data to CMOS	

4.17 Exit Without Saving

Select this option to exit the Setup utility without saving the changes you have made in this session. Typing “Y” will quit the Setup utility without saving the modifications. Typing “N” will return you to Setup utility.

CMOS Setup Utility-Copyright © Award Software	
<ul style="list-style-type: none"> ˘ Standard CMOS Features ˘ Advanced BIOS Features ˘ Advanced Chipset Features ˘ Integrated Peripherals ˘ Power Man ˘ PnP/PCI Con ˘ PC Health Status 	<ul style="list-style-type: none"> ˘ Frequency/Voltage Control Load Fail-Safe Defaults Load Optimized Defaults Set Supervisor Password Exit Without Saving
<div style="background-color: black; color: white; padding: 5px; display: inline-block;">Quit Without Saving (Y/N)? N</div>	
Esc : Quit F10 : Save & Exit Setup	Ç È Æ Å : Select Item
Abandon all Data's	

This page does not contain any information.

Appendix A

Watchdog Timer

Watchdog Features

The Watchdog Timer (WDT) supports the following features and functions:

Selectable prescaler – approximately 1 MHz and approximately 1 KHz
33 MHz clock (30 ns clock ticks)

Multiple modes: WDT and free-running

z Free-running mode:

One stage timer.

Toggles reset system after programmable time.

BIOS (Hance Rapid Item) can test this function, you can setup the time from 1~1024 sec. System enable timer after boot.

z WDT Mode:

Two stage timer:

1. First stage generates IRQ and SMI interrupt after programmable time.

2. Second stage reset system or inverts the previous value.

Used only after first timeout occurs.

Status bit preserved in RTC well for possible error detection and correction. Reset system when OUTPUT is enabled.

Timer may be disabled (default state) or locked (hard reset required to disable WDT). WDT automatic reload of preload value when WDT reload sequence is performed

Watchdog Overview

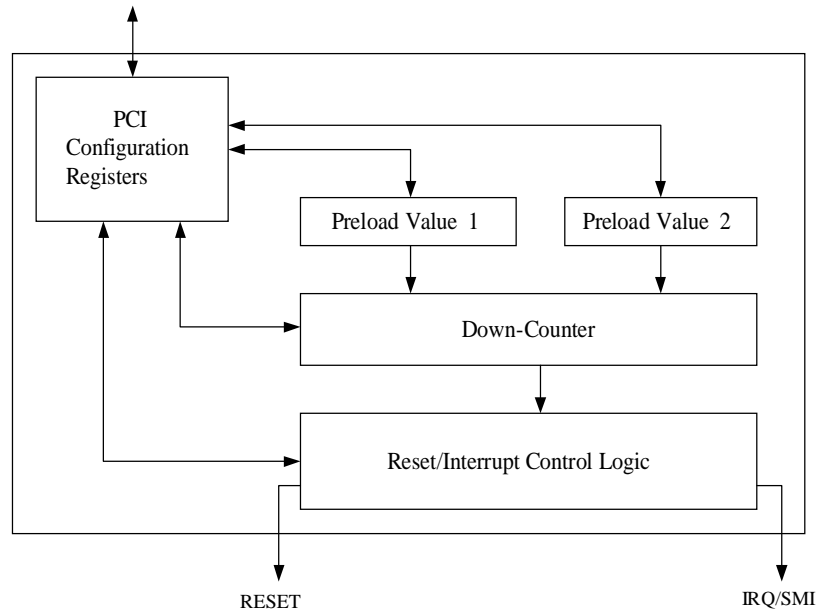

The timer uses a 35-bit down-counter. The counter is loaded with the value from the first Preload register. The timer is then enabled and starts counting down. The time at which the WDT first starts counting down is called the first stage. When the host fails to reload the WDT before the 35-bit down-counter reaches zero, the WDT generates an internal interrupt. After the interrupt is generated, the WDT loads the value from the second Preload register into the WDT's 35-bit down counter and starts counting down. The WDT is now in the second stage. When the host still fails to reload the WDT before the second timeout, the WDT reset the system and sets the timeout bit (WDT_TIMEOUT). This bit indicates that the System has become unstable. The process of reloading the WDT involves the following sequence of writes:

1. Write 80 to offset BAR + 0Ch.
2. Write 86 to offset BAR + 0Ch.
3. Write 1 to WDT_RELOAD in Reload Register.

The same process is used for setting the values in the preload registers. The only difference exists in step 3. Instead of writing a '1' to the WDT_RELOAD, write the desired preload value into the corresponding Preload register. This value is not loaded into the 35-bit down-counter until the next time the WDT reenters the stage. For example, when Preload Value 2 is changed, it is not loaded into the 35-bit down-counter until the next time the WDT enters the second stage.

Watchdog Control Sample

Using the Watchdog Function

Function	Reg.	Assembler
Setting Base Time	PCI Reg. 60h , bit 2 Bit2=0 \uparrow 1ms (default) Bit2=1 \uparrow 1 us	Max. TimeVaule = 0FFFFFFh * 1 ms mov ebx,TimeValue
Read WDT BaseAdress	PCI Reg. 10h ~ 13h	mov eax,8000EC10h mov dx,0cf8h out dx,eax mov dx,0cfch in eax,dx mov edi,eax ;; store BaseAddress to edi
WDT unlock	BaseAddress + 0Ch \uparrow 80h BaseAddress + 0Ch \uparrow 86h	push es ; backup es Reg. xor ax,ax mov es,ax mov ax,8680h mov es:[edi+0ch],al mov es:[edi+0ch],ah
Set Timer Value	BaseAddress + 04h ~ 07h	mov es:[edi+04h],ebx pop es ; restore es Reg.
Set Free Running mode	PCI Reg.68h, bit 3,2 Bit2=1, Free Running mode	mov eax,8000EC68h mov dx,0cf8h out dx,eax mov dl,0fch mov al,04h ;; Free Running mode out dx,al

Reload Timer

Function	Reg.	Assembler
WDT unlock	BaseAddress + 0Ch ↑ 80h BaseAddress + 0Ch ↑ 86h	push es ; backup es Reg. xor ax,ax mov es,ax mov ax,8680h mov es:[edi+0ch],al mov es:[edi+0ch],ah
Reload Teimer	BaseAddress + 0Ah Bit 8=1, reload timer value	mov ax,es:[edi+0ah] or ax,0100h mov es:[edi+0ah],ax pop es ; restore es Reg.

Disable Timer

Function	Reg.	Assembler
Enable WDT with Free Running mode	PCI Reg.68h, bit 3,2 Bit1=0, Disable WDT	mov eax,8000EC68h mov dx,0cf8h out dx,eax mov dl,0fch in al,dx and al,0fdh ;; clear bit1 out dx,al

Enable Timer

Function	Reg.	Assembler
Enable WDT with Free Running mode	PCI Reg.68h, bit 3,2 Bit1=1, Enable WDT	mov eax,8000EC68h mov dx,0cf8h out dx,eax mov dl,0fch in al,dx or al,02h ;; set bit1 out dx,al

This page does not contain any information.

Appendix B

Serial ATA Setup Information

The board provides the last technology IDE connector. The two slim type connector of Serial ATA are for fast IDE data transfer. Nowadays the Serial ATA can provide the data transfer rate up to 150MB/sec. This is better than the traditional Parallel ATA (Ultra ATA/133) interface for 133MB/sec.

Parallel ATA and Serial ATA BIOS Setup

CMOS Setup Utility-Copyright © 1984-2001 Award Software

On-Chip IDE Device

IDE DMA transfer Access	Enabled	
On-Chip Primary PCI IDE	Enabled	Menu Level f
IDE Primary Master PIO	Auto	
IDE Primary Master PIO	Auto	
IDE Primary Master UDMA	Auto	
IDE Primary Master UDMA	Auto	
On-Chip Primary PCI IDE	Enabled	
IDE Secondary Master PIO	Auto	
IDE Secondary Master PIO	Auto	
IDE Secondary Master UDMA	Auto	
IDE Secondary Master UDMA	Auto	
** On-Chip Serial ATA Setting **		
SATA Mode	IDE	
On-Chip Serial ATA	Auto	
Serial ATA Port0	Primary Master	
Serial ATA Port1	Primary Master	
IDE HDD Block Mode	Enabled	
␣␣␣␣␣␣ : Move Enter: Select +/-/PU/PD: Value F10: Save ESC: Exit F1: General Help F5: Previous Values F6: Fail-Safe Defaults F7: Optimized Defaults		

On-Chip Serial ATA configuration

This option allows you to setup your Serial ATA work with the modes below:

- z Disable:
This will disable any Serial ATA Device.
- z Auto:
This will allow you to let the BIOS auto configure your IDE drivers if you don't know how to select the mode.
- z Combined Mode:
This will let you configure the Serial ATA and Parallel ATA enforced to max of 2 IDE devices on each Serial and Parallel ATA.
- z Enhance Mode:
This will allow you to enable the max 6 IDE drivers.
(Notice! This mode only can work under Windows 2000/XP).
- z SATA Only Mode:
This allows you to force the Serial ATA work in legacy

Serial ATA Port Mode

This option allows you to setup your Serial ATA work with the modes below:

- z IDE Mode:
On-Chip Serial ATA configuration.
- z RAID Mode:
Support Intel Software RAID

Parallel ATA and Serial ATA Device Setup

The 6300ESB (Hance Rapids) has defined the device usage below:

- z New OS IDE mode:
6300ESB can work with up to 6 IDE Drivers under Windows 2000 or Windows XP.
- z Traditional OS IDE mode:
6300ESB can only work with up to 4 IDE Drivers under MS-DOS, Windows 98 or Windows ME, and Windows NT 4.0.

Operating System	Parallel ATA		Serial ATA	
	Primary (2 Devices)	Secondary (2 Devices)	SATA1 (1 Device)	SATA2 (1 Device)
Windows 2000/XP	Master/Slave	Master/Slave	SATA0	SATA1
Windows 98/NT/ME	Master/Slave	NA	Secondary Master	Secondary Slave
	NA	Master/Slave	Primary Master	Primary Slave
	Master/Slave	Master/Slave	NA	NA

Any advice or comments about our products and service, or anything we can help you with please don't hesitate to contact with us. We will do our best to support you for your products, projects and business

Global American Inc.

Address: 17 Hampshire Drive
Hudson, NH 03051

TEL: Toll Free (U.S. Only) 800-833-8999
(603)886-3900

FAX: (603)886-4545

Website: <http://www.globalamericaninc.com>

E-Mail: salesinfo@globalamericaninc.com

