



User's Manual

3300565

Copyright

Copyright 2006. All rights reserved. This document is copyrighted and all rights are reserved. The information in this document is subject to change without prior notice to make improvements to the products.

This document contains proprietary information and protected by copyright. No part of this document may be reproduced, copied, or translated in any form or any means without prior written permission of the manufacturer.

All trademarks and/or registered trademarks contains in this document are property of their respective owners.

Disclaimer

The company shall not be liable for any incidental or consequential damages resulting from the performance or use of this product.

The company does not issue a warranty of any kind, express or implied, including without limitation implied warranties of merchantability or fitness for a particular purpose.

The company has the right to revise the manual or include changes in the specifications of the product described within it at any time without notice and without obligation to notify any person of such revision or changes.

Trademark

All trademarks are the property of their respective holders.

Any questions please visit our website at <http://www.globalamericaninc.com>

Packing List

Please check the package before you starting setup the system

Hardware:

3300565 series motherboard x 1

Cable Kit:



44-pin ATA33 IDE Cable x 1



Serial ATA Ribbon Cable x 2



PS2 Cable x 1



26-pin Slim Type Floppy Cable x 1

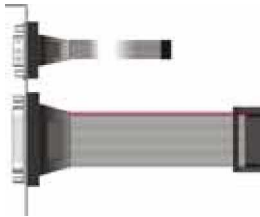

COM Port & Printer Port Cable x 1



Power Cable x 1



40-pin ATA100 IDE Cable x 1

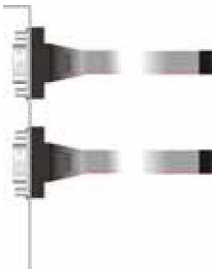

COM Port Cable x 1



Audio Port Cable x 1

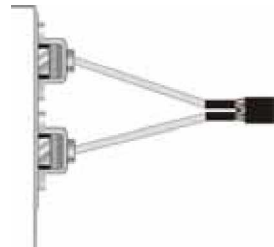

USB Cable x 1

Printed Matters:

User's Manual x 1

Driver CD x 1

Index

Chapter 1 <Introduction>	7
1.1 <Product Overview>.....	7
1.2 <Product Specification>	8
1.3 <Mechanical Drawing>.....	10
1.4 <Block Diagram>.....	11
Chapter 2 Hardware Setup	12
2.1 <Connector Location>	12
2.2 <Jumper Reference>.....	14
2.3 <Connector Reference>.....	15
2.3.1 <Internal Connector>.....	15
2.3.2 <External Connector>.....	15
2.4 <CPU and Memory Setup>	16
2.4.1 < CPU>.....	16
2.4.2 <Memory>	16
2.5 <CMOS ATX Setup>.....	17
2.6 <Enhanced IDE & CF Interface>.....	18
2.7 <Serial ATA Interface>.....	19
2.8 <Floppy Port>.....	20
2.9 <LAN Interface>	21
2.10 <Onboard Display Interface>.....	22
2.10.1 <Analog VGA Interface>.....	22
2.10.2 < Digital Display >.....	23
2.11 <Onboard Audio Interface>.....	27
2.12 <USB2.0 Interface>.....	28
2.13 <GPIO Interface>	30
2.14 <Serial Port Jumper Setting>	31
2.15 <Power and Fan Connector>.....	33

2.15.1 <Power Input>	33
2.15.2 <Power Output>.....	34
2.15.3 <Fan Connector>.....	34
2.16 <Indicator and Switch>.....	35
Chapter 3 <System Configuration>.....	37
3.1 <SATA RAID Configuration>.....	37
3.2 <Audio Configuration>	39
3.3 <Display Configuration>.....	40
Chapter 4 <BIOS Setup>	44
Appendix A <I/O Port Pin Assignment>	46
A.1 <IDE Port>	46
A.2 <Floppy Port>	48
A.3 <IrDA Port>	48
A.4 < CRT Port >.....	49
A.5 <Serial ATA Port>.....	49
A.6 <Serial Port>	49
A.7 <LAN Port>	50
Appendix B <Flash BIOS>.....	52
B.1 BIOS Auto Flash Tool	52
B.2 Flash Method	52
Contact Information	54

(The Page is Left For Blank)

Chapter 1 <Introduction>

1.1 <Product Overview>

3300565 is the 5.25 inch embedded miniboard based on VIA chipset. It integrates VIA embedded chipset for CN700 with VT8237R Plus, DDR 333/400 SDRAM, and serial ATA with RAID to provide the economical embedded platform.

VIA CN700 & VT8237R Plus Chipset

The board comes with the VIA embedded chipset of CN700, supports DDR 333/400 SDRAM, integrated the S3 Graphics UniChrome Pro IGP graphics core, hardware MPEG-2 acceleration.

The VT8237R Plus provides the board to support Ultra V-Link (533MB/s) with CN700, two serial ATA ports with RAID array function, 6 x USB2.0 ports and 5.1 channel AC97 audio.

Multimedia solution

Based on VIA CN700 chipset, the board provides 18/24-bit LVDS interface, which supports dual independent display with CRT.

Onboard AC97 codec provides the high quality of sound including 5.1-channel stereo DACs.

Four LAN Interface

3300565 also comes with four Giga LAN interface, support boot-on-LAN and wake-on-LAN function.

High Speed Hot-plug Interface

Based on VIA VT8237R Plus the board provides 6 USB2.0 interfaces with up to 480Mbps of transferring rate.

Expanded UCR for remote Operating SETUP Bios Feature

Expanded Universal Console Redirection (UCR) is a feature for monitoring POST messages and running Setup and an operation system from a remote serial terminal.

1.2 <Product Specification>

General Specification

Form Factor	5.25 inch miniboard
CPU	VIA V4/Eden 1.0GHz processor L1/L2 Cache: 128/128KB Front side bus: 400MHz
Memory	1 x 184-pin DDR 333/400 SDRAM up to 1GB,onboard optional 256MB DDR SDRAM Unbuffered, none-ECC memory supported only
Chipset	VIA CN700 and VT8237R Plus
BIOS	Phoenix-Award v6.00PG 4Mb PnP flash BIOS
Green Function	Power saving mode includes doze, standby and suspend modes. ACPI version 1.0 and APM version 1.2 compliant
Watchdog Timer	System reset programmable watchdog timer with 1 ~ 255 sec./min. of timeout value
Real Time Clock	VIA VT8237R Plus built-in RTC with lithium battery
Enhanced IDE	Enhanced IDE interface supports dual channels and up to 4 ATAPI devices at Ultra DMA133 One 40-pin and one 44-pin IDE port onboard One Compact Flash Type II socket on solder side
Serial ATA	VIA VT8237R Plus integrates 2 Serial ATA interface RAID 0, 1 array Technology supported

Multi-I/O Port

Chipset	VIA VT8237R Plus with Winbond W83697UG controller
Serial Port	One external & three internal RS-232 serial ports
USB Port	Four external & four internal Hi-Speed USB 2.0 ports with 480Mbps of transfer rate
Parallel Port	One 26-pin internal parallel port
Floppy Port	One slim type Floppy port
IrDA Port	One IrDA compliant Infrared interface supports SIR
K/B & Mouse	Internal PS/2 keyboard and mouse
GPIO	One 12-pin Digital I/O connector with 8-bit programmable I/O interface
Hardware Monitor	Fan speed, CPU temperature and voltage monitoring

VGA Display Interface

Chipset	VIA CN700 built-in S3 Graphics UniChrome Pro IGP graphics core
Core Frequency	200MHz
Memory	BIOS selectable 16/32/64MB shard with system memory
Display Type	CRT, LCD monitor with analog display
Connector	External DB15 female connector on rear I/O panel Internal 40-Pin LVDS connector

Ethernet Interface

Chipset	REALTEK 8110S-32
Type	10Base-T / 100Base-TX / 1000Base-TX auto-switching Fast Ethernet Full duplex, IEEE802.3U compliant
Connector	Four External RJ45 connectors with LED on rear I/O panel

Audio Interface

Chipset	REALTEK ALC655
Interface	5.1 channel surround audio with Line-in, Line-out and MIC-in
Connector	Onboard audio connector with pin header Onboard CD-IN connector

Expansive Interface

PCI	1 x PCI slot supports up to two PCI devices through riser card
Mini PCI	1 x Mini PCI socket

Power and Environment

Power Requirement	DC 12V input with external DC Jack or onboard 4-pin connector
Dimension	146 (L) x 203 (H) mm
	Storage within -20 ~ 85 °C (°F)

Software support

Operation System	Windows 2000, Windows XP, Windows CE 4.0 or later, Windows XP Embedded Linux (Fedora Core 1, Mandrake 9.2 and Red Hat 9.0)
------------------	--

Ordering Code

3300565A	VIA V4 Eden 1G With Onboard VGA, AUDIO, Giga LAN, USB2.0, 4 x COM, FDD, LPT, GPIO, LVDS, Mini PCI, SATA
3300565B	The same as above and with 256MB DDR SDRAM
3107615	AC-DC Adapter with 12V, 80W DC Jack output

1. The specifications may be different as the actual production.

For further product information please visit the website at
<http://www.globalamericaninc.com>

1.3 <Mechanical Drawing>

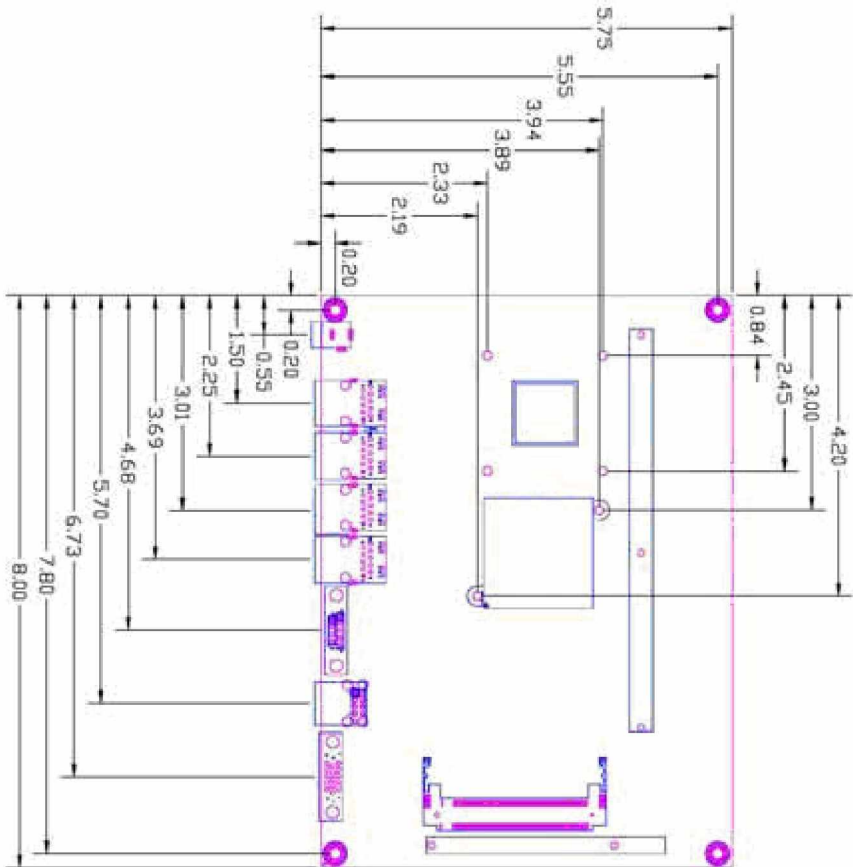

1.4 <Block Diagram>

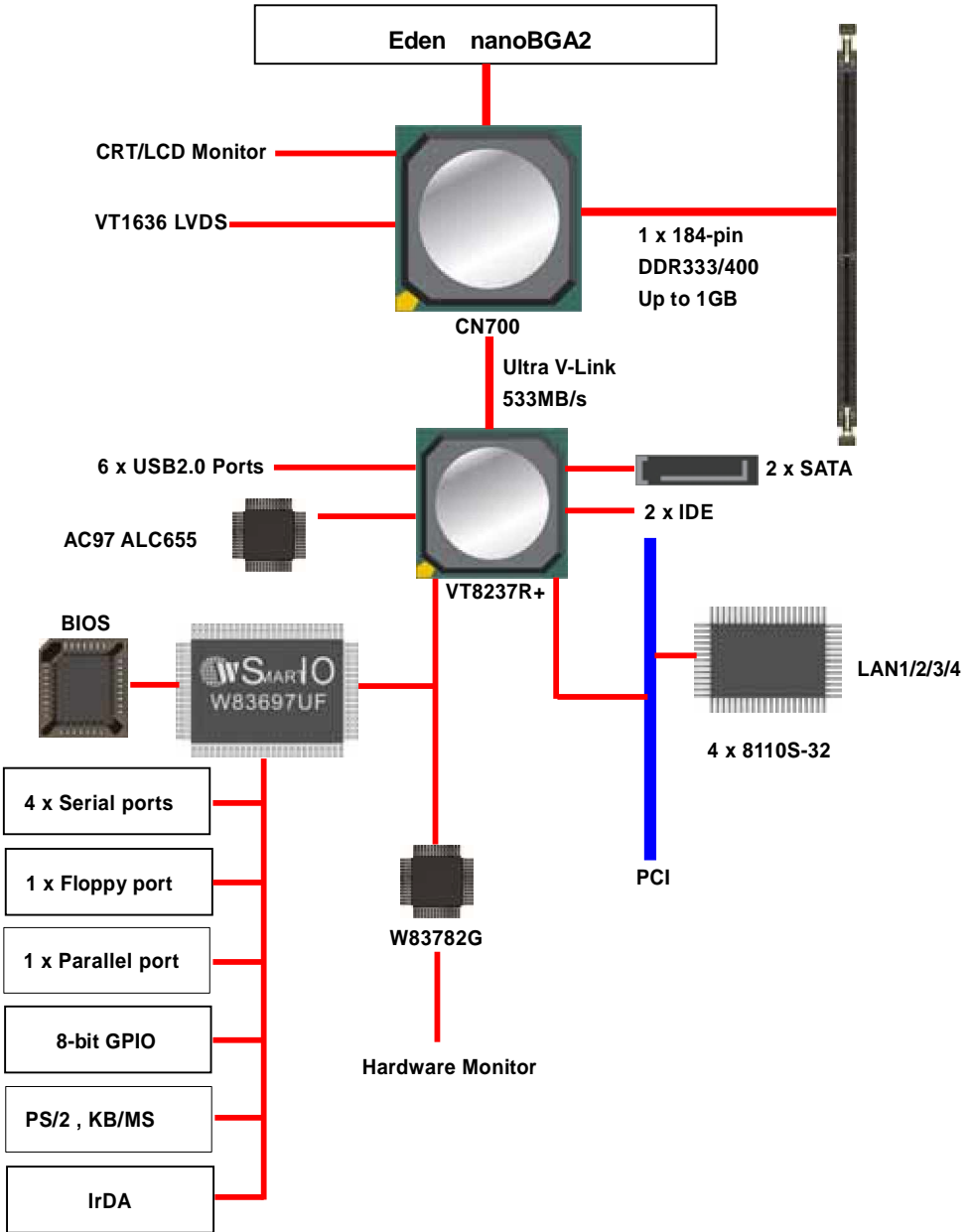

Chapter 2 <Hardware Setup>

2.1 <Connector Location>

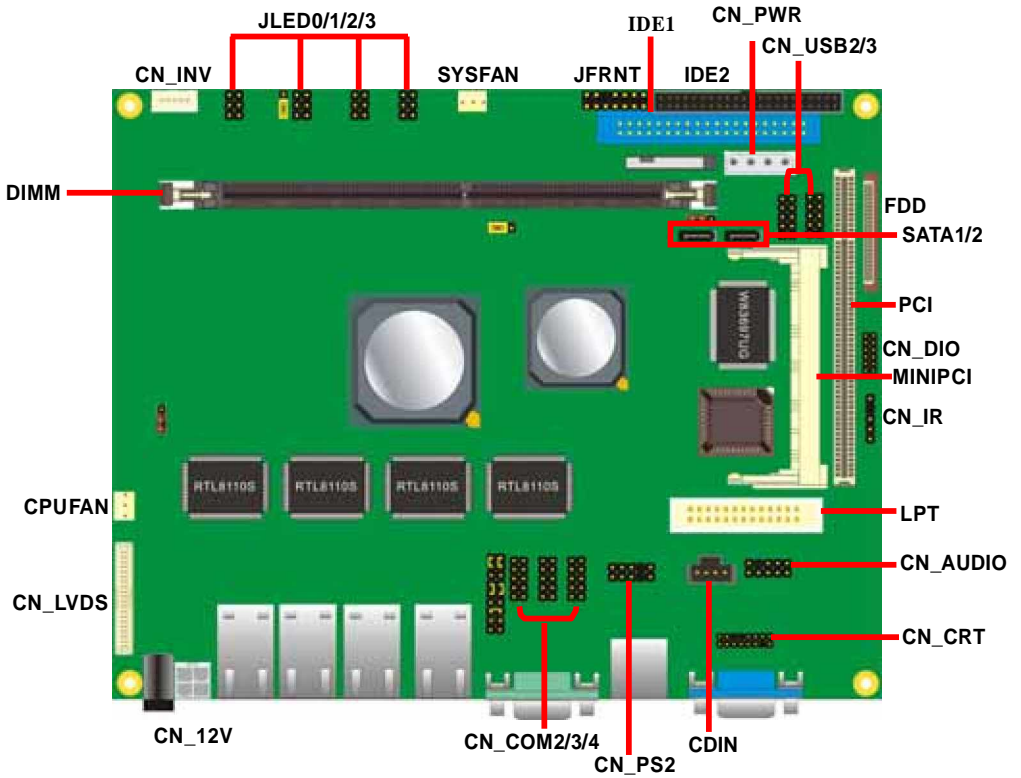

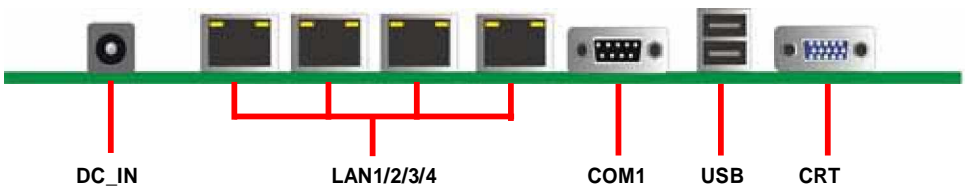
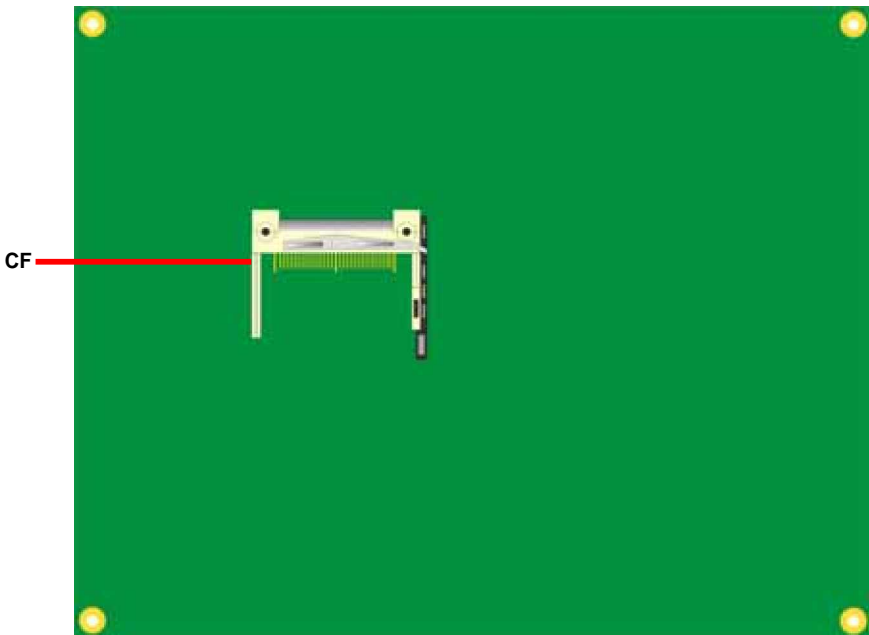

2.2 <Jumper Reference>

Jumper	Function
JRTC	CMOS Operating/Clear Setting
JCFSEL	Compact Flash address mode setting
JVLCD	LCD Panel Voltage Setting
JAT	AT/ATX mode setting
JCSEL1/2	COM2 RS232/422/485 mode setting

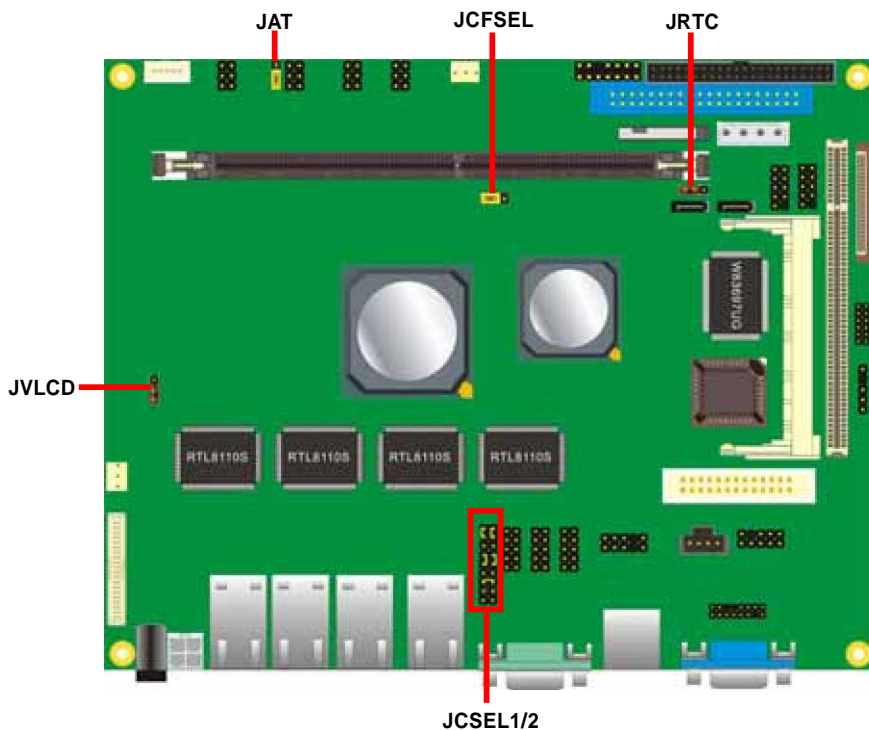

2.3 <Connector Reference>

2.3.1 <Internal Connector>

Connector	Function	Remark
DIMM	184-pin DDR SDRAM DIMM	Standard
IDE1	40-pin primary IDE connector	Standard
IDE2	44-pin secondary IDE connector	Slim
FDD	26-pin slim type floppy connector	Slim
SATA1/2	7-pin Serial ATA connector	Standard
CN_12V	4-pin power supply connector	Standard
CN_AUDIO	5 x 2-pin audio connector	Standard
CDIN	4-pin CD-ROM audio input connector	Standard
CN_DIO	6 x 2-pin digital I/O connector	Standard
CN_USB 2/3	5 x 2-pin USB connector	Standard
CPUFAN	3-pin CPU cooler fan connector	Standard
SYSFAN	3-pin system cooler fan connector	Standard
CN_COM2/3/4	5 x 2-pin RS232 serial port	Standard
CN_IR	5-pin IrDA connector	Standard
CF	Compact Flash Type II socket	Standard
CN_LVDS	20 x 2-pin LVDS LCD interface	Standard
CN_INV	5-pin LCD inverter connector	Standard
JLED0/1/2/3	3 x 2-pin LED connector	Standard
CN_PWR	4-pin power output connector	Standard
PCI	Slim 32bit PCI slot	Slim
MINIPCI	Mini-PCI socket	Standard
LPT	13 x 2-pin printer connector	Standard
CN_PS2	5 x 2-pin PS2 connector	Standard
JFRNT	14-pin switch/indicator connector	Standard

2.3.2 <External Connector>

Connector	Function	Remark
CRT	DB15 VGA connector	Standard
USB	Dual USB 2.0 connector	Standard
COM1	DB9 Serial port connector	Standard
RJ45_1/2/3/4	Four RJ45 LAN connector	Standard
DC_IN	DC 12V input jack	Standard

2.4 <CPU and Memory Setup>

2.4.1 < CPU>

The board supports VIA Eden processor, default ratio is Eden 1G (400MHz) with heatsink only.

2.4.2 <Memory>

The board supports one 184-pin DDR333/400 SDRAM and up to 1GB of capacity, only non-ECC, unbuffered memory is supported.

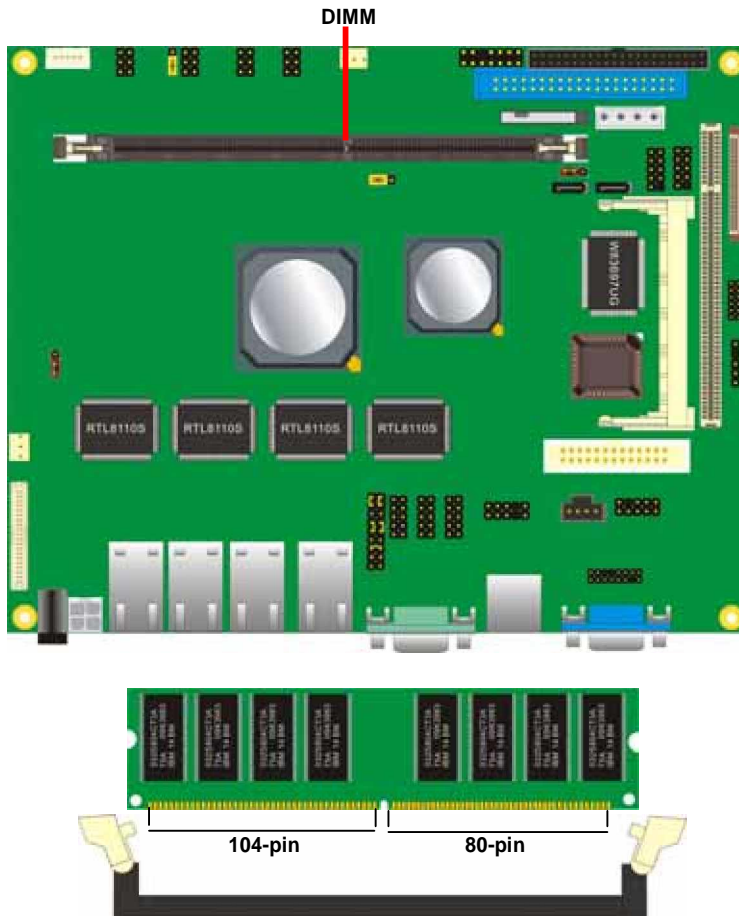

Please check the pin number to match the socket side well before installing memory module.

2.5 <CMOS ATX Setup>

The board's data of CMOS can be setting in BIOS. If the board refuses to boot due to inappropriate CMOS settings, here is how to proceed to clear (reset) the CMOS to its default values.

Jumper: JRTC

Type: Onboard 3-pin jumper

JRTC	Mode
1-2	Clear CMOS
2-3	Normal Operation
Default setting	

Jumper: JAT

Type: Onboard 3-pin jumper

JAT	Mode
1-2	AT mode
2-3	ATX mode -default
Default setting	

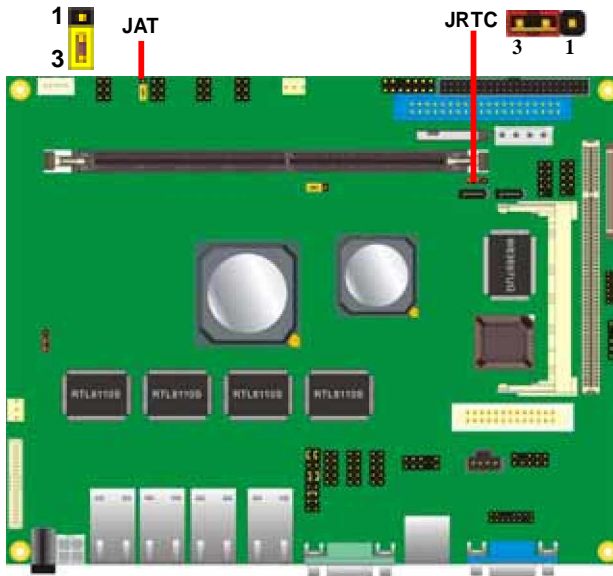

2.6 <Enhanced IDE & CF Interface>

The board supports two enhanced IDE interface, dual channel for 4 ATAPI devices with ATA33. Based on embedded application, the board has one 44-pin IDE connector +5V supported for disk on module.

The board also provides a Compact Flash Type II socket with jumper (**JCFSEL**) selectable slave/Master mode on secondary IDE channel.

Jumper: **JCFSEL**

Type: onboard 3-pin header

JCFSEL	Mode
1-2	Master
2-3	Slave

Default setting

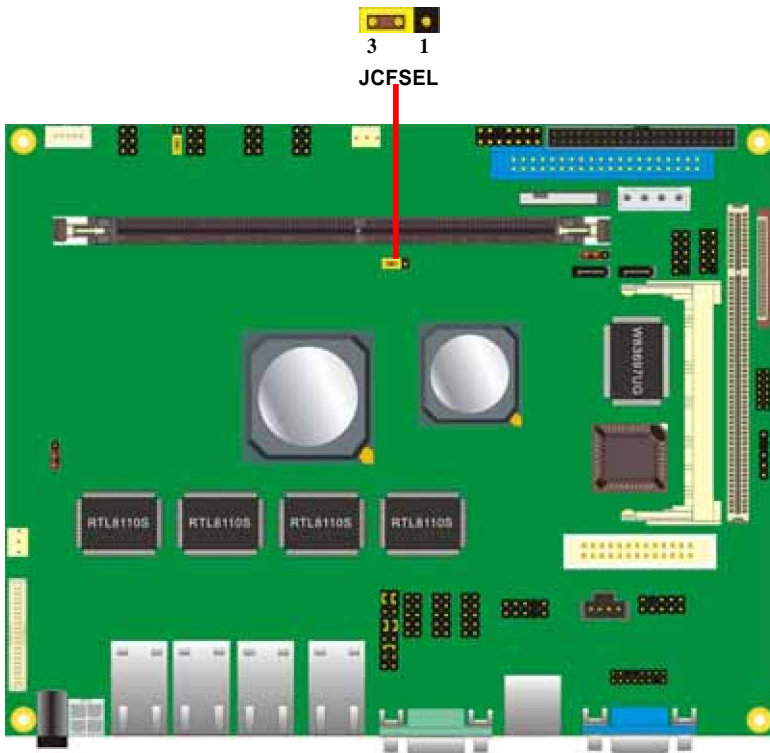

2.7 <Serial ATA Interface>

Based on VIA VT8237R Plus Southbridge, the board supports two Serial ATA interfaces with RAID 0 and 1 array function. The following is the list of the specification of the Serial ATA.

1. Complies with Serial ATA Specification Revision 1.0
2. Dual Channel master mode PCI
3. On-chip two-channel Serial ATA (S-ATA) PHY for support of up to two S-ATA devices directly.
4. S-ATA drive transfer rate is capable of up to 150 MB/s per channel (serial speed of 1.5 Gbit/s).

For more information please visit VIA website (www.globalamericaninc.com)

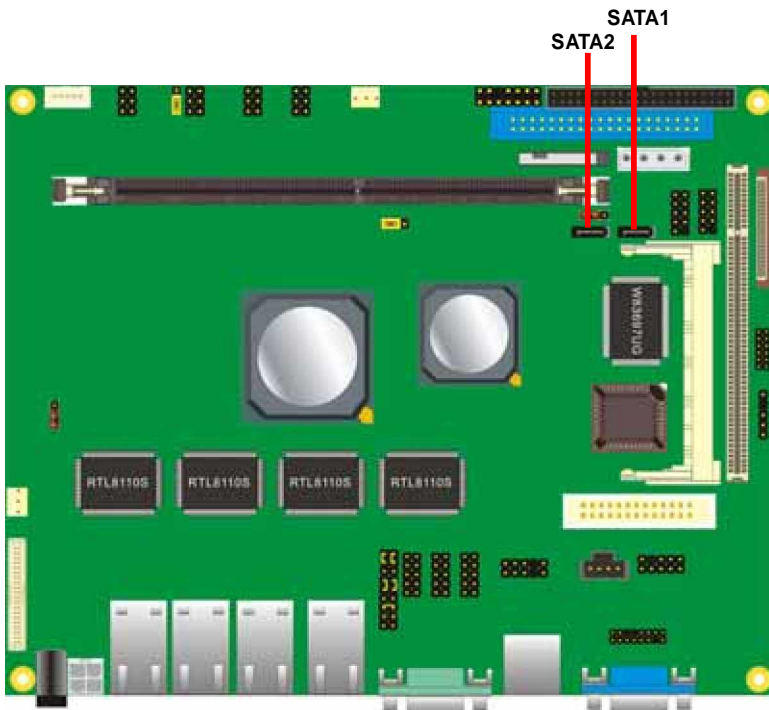

2.8 <Floppy Port>

The board provides a slim type floppy port; please use the 26-pin ribbon cable in the package to connect the floppy device.

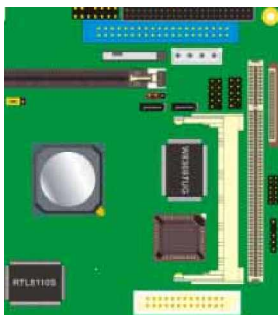
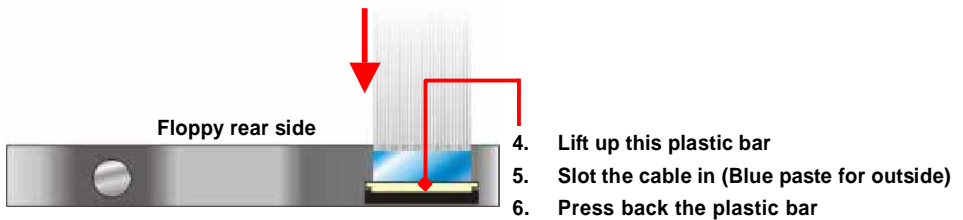
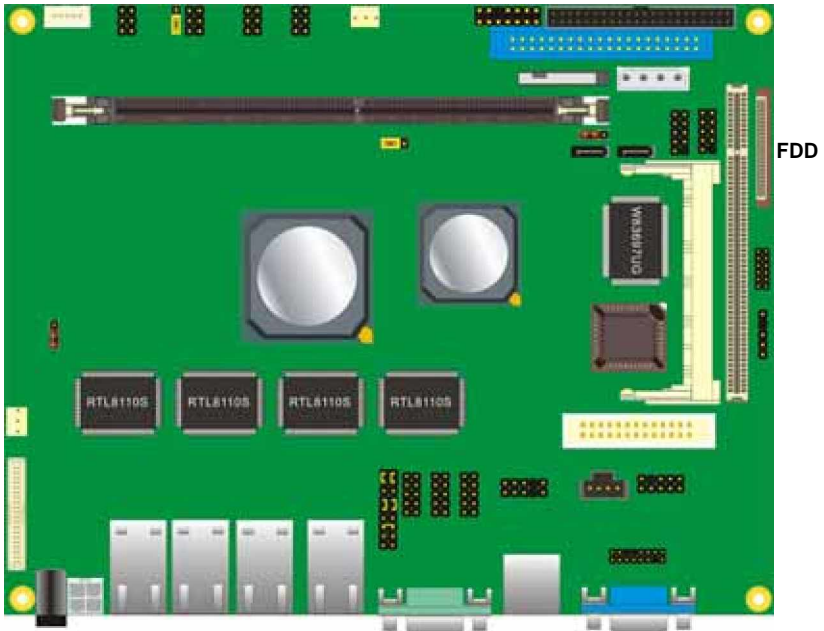

2.9 <LAN Interface>

The board provides four GigaLAN interfaces with REALTEK 8110S-32 PCI controller, and compliant with standard IEEE 802.3 Ethernet interface for 100BASE-TX.

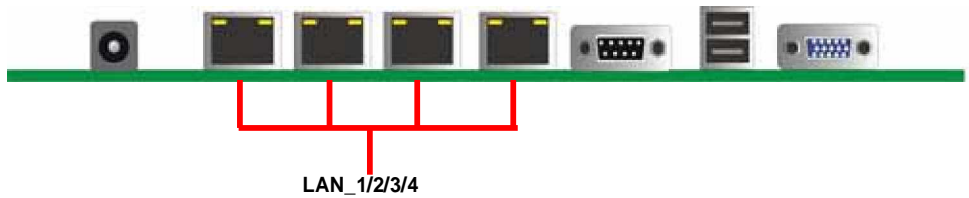

2.10 <Onboard Display Interface>

Based on VIA CN700, the board supports integrated S3 Graphics UniChrome Pro IGP graphics, with BIOS selectable 16/32/64MB shared with system memory for frame buffer.

2.10.1 <Analog VGA Interface>

The board provides a DB15 CRT connector on the rear I/O panel.

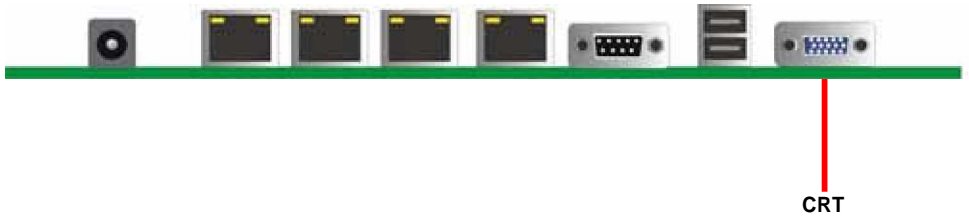

2.10.2 <Digital Display>

The board provides one 40-pin LVDS connector for 18/24-bit single/dual channel panels, supports up to 1600 x 1200 (UXGA) of resolution, with one LCD backlight inverter connector and one jumper for panel voltage setting

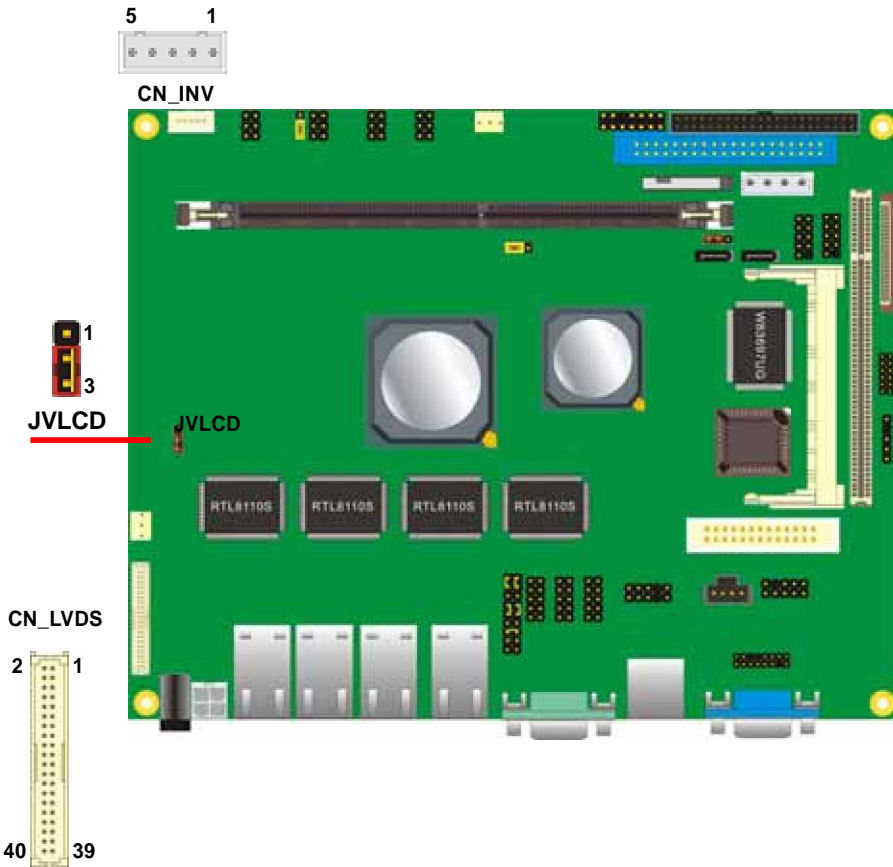

Connector: **CN_INV**

Type: 5-pin LVDS Power Header

Connector model: **JST B5B-XH-A**

Pin	Description
1	+12V
2	GND
3	GND
4	GND
5	ENABKL

Connector: **JVLCD**

Type: 3-pin Power select Header

Pin	Description
1	VCC(5V)
2	LCDVCC
3	VCC3(3.3)

Connector: **CN_LVDS**

Type: onboard 40-pin connector for LVDS connector

Connector model: **HIROSE DF13-40DP-1.25V**

Pin	Signal	Pin	Signal
2	LCDVCC	1	LCDVCC
4	GND	3	GND
6	ATX0-	5	BTX0-
8	ATX0+	7	BTX0+
10	GND	9	GND
12	ATX1-	11	BTX1-
14	ATX1+	13	BTX1+
16	GND	15	GND
18	ATX2-	17	BTX2-
20	ATX2+	19	BTX2+
22	GND	21	GND
24	ACLK-	23	BTX3-
26	ACLK+	25	BTX3+
28	GND	27	GND
30	ATX3-	29	BCLK-
32	ATX3+	31	BCLK+
34	GND	33	GND
36	N/C	35	N/C
38	N/C	37	N/C
40	N/C	39	N/C

To setup the LCD, you need the component below:

1. A panel with LVDS interfaces.
2. An inverter for panel's backlight power.
3. A LCD cable and an inverter cable.

For the cables, please follow the pin assignment of the connector to make a cable, because every panel has its own pin assignment, so we do not provide a standard cable; please find a local cable manufacture to make cables.

LCD Installation Guide:

1. Preparing the **3300565, LCD panel** and the **backlight inverter**.

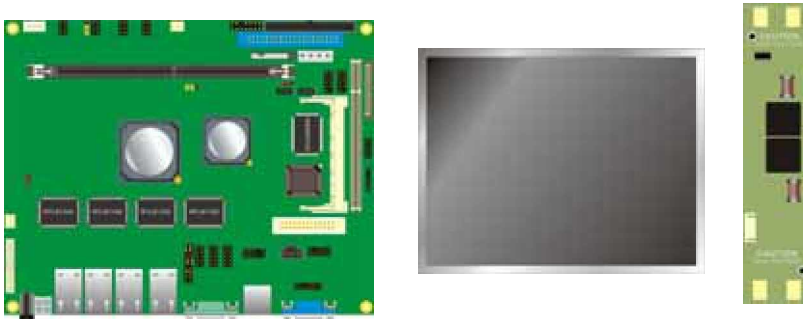

2. Please check the datasheet of the panel to see the voltage of the panel, and set the jumper **JVLCD** to +5V or +3.3V.
3. You would need a LVDS type cable.



4. To connect all of the devices well.

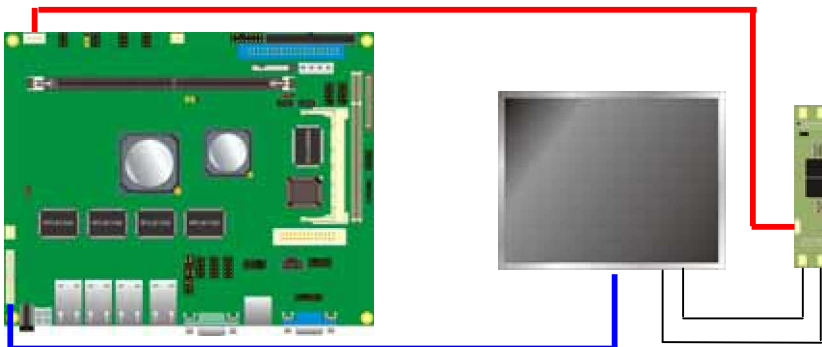

After setup the devices well, you need to select the LCD panel type in the BIOS.

The panel type mapping is list below:

3300565 BIOS panel type selection form			
VGA ROM VERSION: 9Y-9X-00-20			
NO.	Resolution	Color	Channel
0	640 x 480	18	1
1	800 x 600	18	1
2	1024 x 768	18	1
3	1280 x 768	18	1
4	1280 x 1024	24	1
5	1400 x 1050	18	2
6	1600 x 1200	18	2
7	1280 x 800	18	1
8	640 x 480	18	2
9	1024 x 768	18	2
A	1024 x 768	24	1
B	1024 x 768	24	2
C	1280 x 768	24	1
D	1280 x 1024	24	2
E	1400 x 1050	24	2
F	1600 x 1200	24	2

2.11 <Onboard Audio Interface>

The board provides the onboard AC97 5.1-channel audio interface with Realteck ALC655.

Connector: CN_AUDIO

Type: 10-pin (2 x 5) header (pitch = 2.54mm)

Pin	Description	Pin	Description
1	Line/SURR – Left	2	Ground
3	Line/SURR – Right	4	MIC1/CEN
5	MIC2/LEF	6	Ground
7	N/C	8	Line Out– Left
9	Line Out – Right	10	Ground

Connector: CDIN

Type: 4-pin header (pitch = 2.54mm)

Pin	Description
1	CD – Left
2	Ground
3	Ground
4	CD – Right

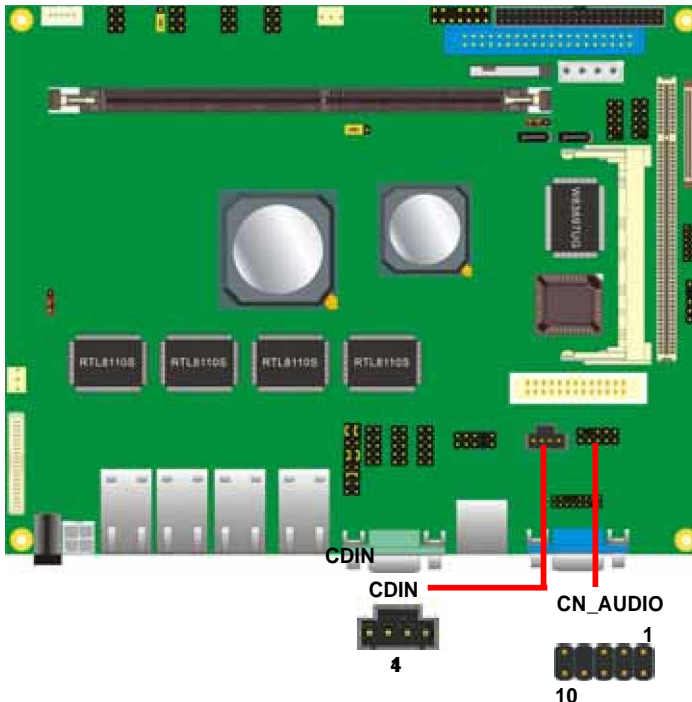

2.12 <USB2.0 Interface>

Based on VIA VT8237R Plus, the board provides 6 USB2.0 ports. The USB2.0 interface provides up to 480Mbps of transferring rate.

Interface	USB2.0
Controller	VIA VT8237R+
Transfer Rate	Up to 480Mb/s
Output Voltage	500mA

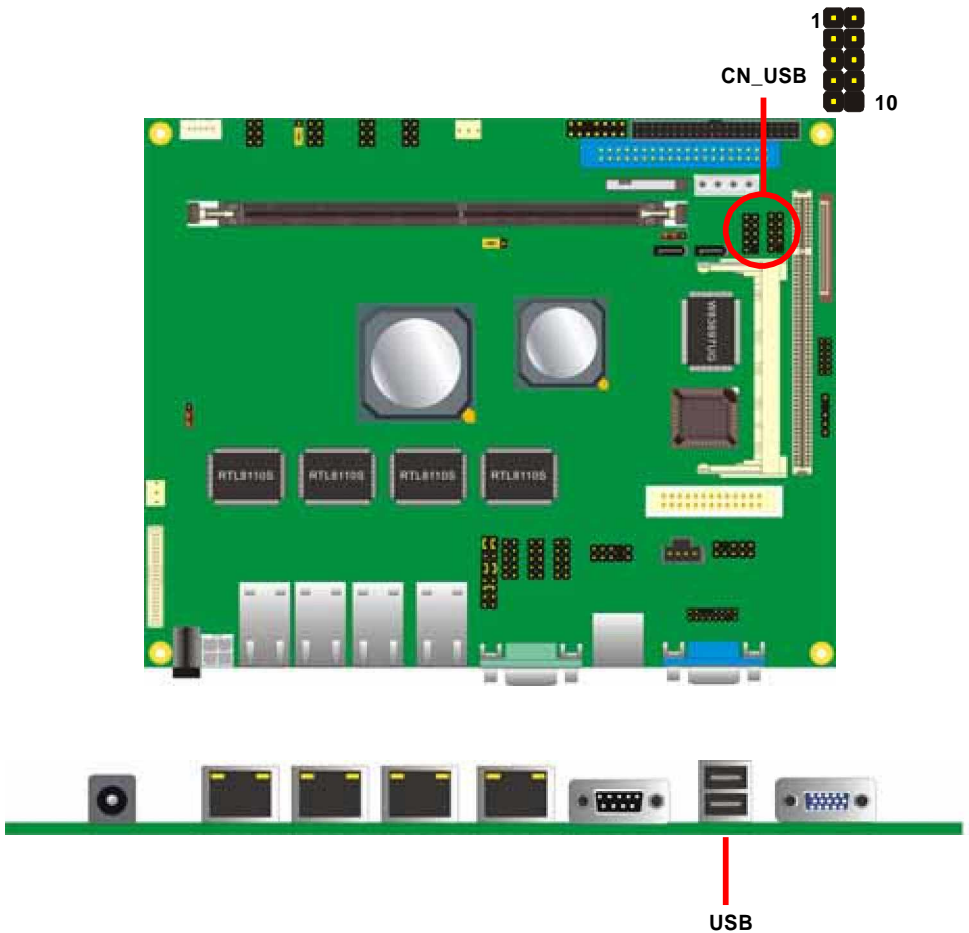

Connector: **CN_USB**

Type: 10-pin (5 x 2) header for USB2/3 Ports

Pin	Description	Pin	Description
1	VCC	2	VCC
3	Data0-	4	Data1-
5	Data0+	6	Data1+
7	Ground	8	Ground
9	Ground	10	N/C

PS: The USB2.0 will be only active when you connecting with the USB2.0 devices, if you insert an USB1.1 device, the port will be changed to USB1.1 protocol automatically. The transferring rate of USB2.0 as 480Mbps is depending on device capacity, exact transferring rate may not be up to 480Mbps.

2.13 <GPIO Interface>

The board provides a programmable 8-bit digital I/O interface; you can use this general purpose I/O port for system control like POS or KIOSK.

Connector: **CN_DIO**

Type: onboard 2 x 6-pin header, pitch=2.0mm

Pin	Description	Pin	Description
1	Ground	2	Ground
3	GP0	4	GP4
5	GP1	6	GP5
7	GP2	8	GP6
9	GP3	10	GP7
11	VCC	12	+12V

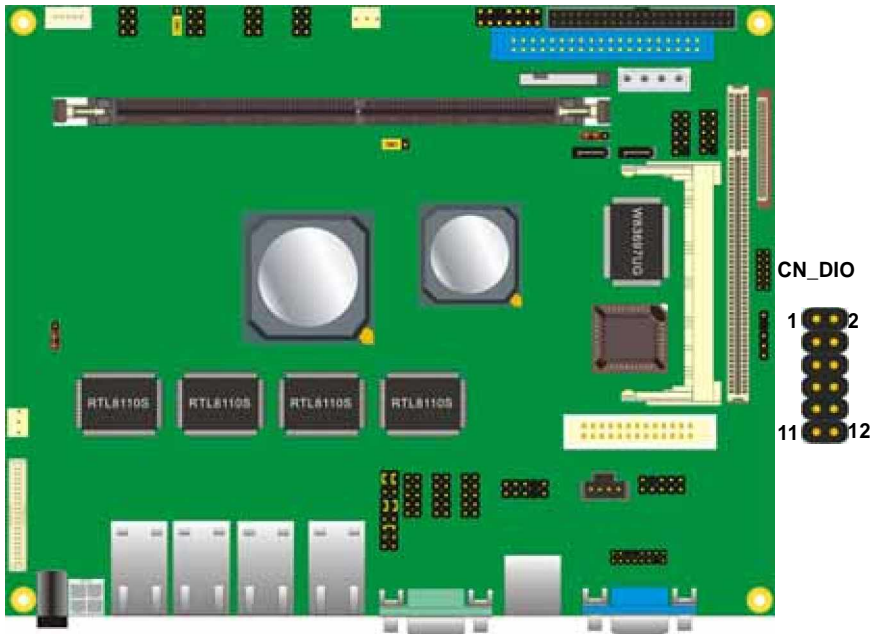





2.14 <Serial Port Jumper Setting >

The board provides four RS232 serial ports, with jumper selectable RS422/485 for COM2.

Connector: **CN_COM2/3/4**

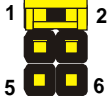
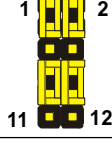
Type: 10-pin (5 x 2) header for COM2/3/4

Pin	Description	Pin	Description
1	DCD/422RX-/485-	2	RXD/422RX+/485+
3	TXD/422TX+	4	DTR/422TX-
5	GND	6	DSR
7	RTS	8	CTS
9	RI	10	N/C

	JCSEL	JCSEL
RS-232		
RS-485		
RS-422		

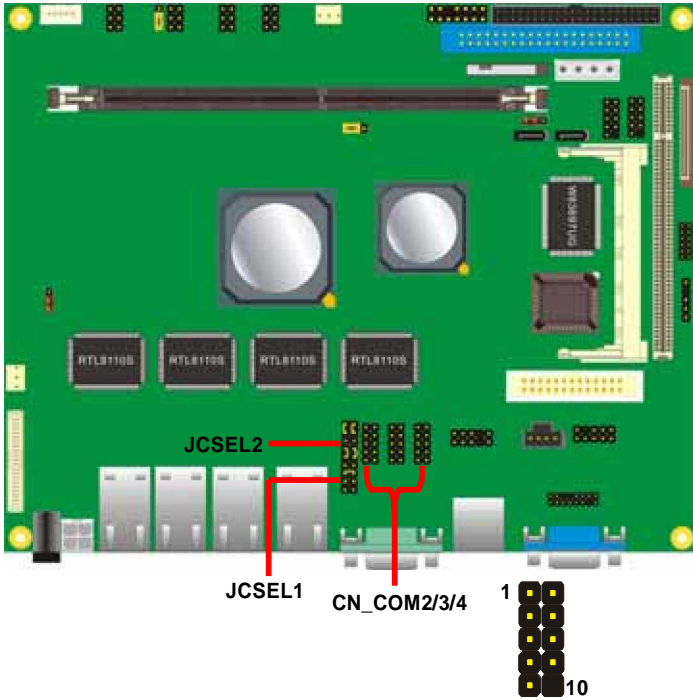

2.15 <Power and Fan Connector>

The board comes with a 2-pin DC-Jack power connector for DC 12V input, it also has one 4-pin P4 additional use power connector for internal power supply, you can choose one of them to meet your application.

2.15.1 <Power Input>

Connector: **CN_12V**

Type: 4-pin DC power connector

Pin	Description	Pin	Description
1	+12V	2	+12V
3	Ground	4	Ground

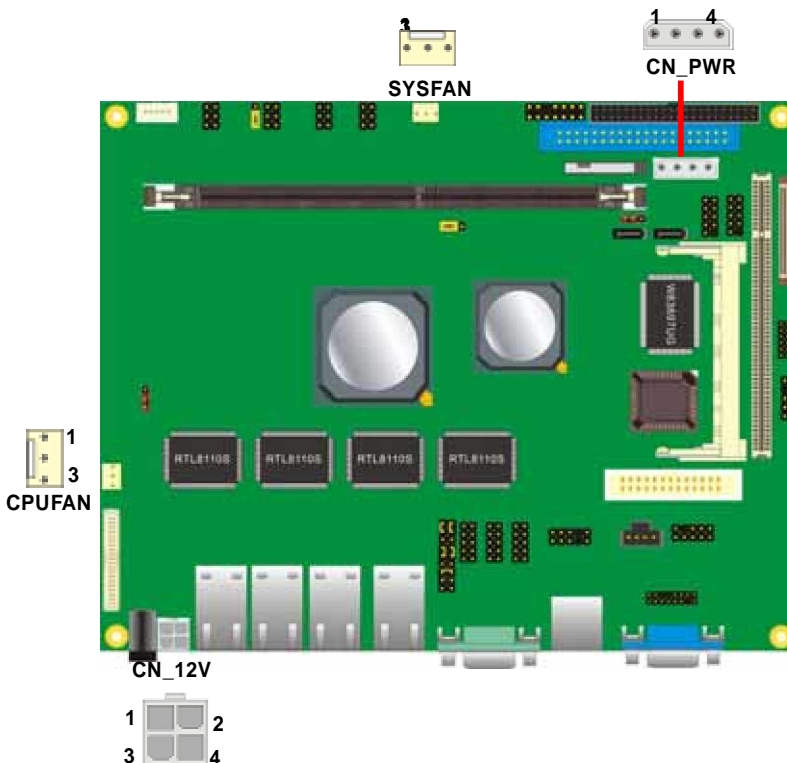

2.15.2 <Power Output>

Connector: **CN_PWR**

Type: 4-pin P-type connector for +5V/+12V **output**

Pin	Description	Pin	Description	Pin	Description	Pin	Description
1	+5V	2	Ground	3	Ground	4	+12V

Note: Maximum output voltage: 12V/5A & 5V/3A

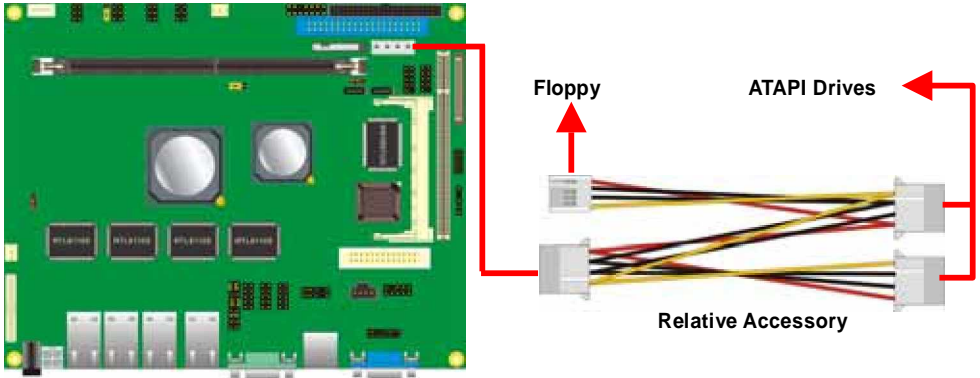

2.15.3 <Fan Connector>

Connector: **CPUFAN, SYSFAN**

Type: 3-pin fan wafer connector

Pin	Description	Pin	Description	Pin	Description
1	Ground	2	+12V	3	Fan Control

2.16 <Indicator and Switch>

The **JFRNT** provides front control panel of the board, such as power button, reset and beeper, etc. Please check well before you connecting the cables on the chassis.

Connector: **JFRNT**

Type: onboard 14-pin (2 x 7) 2.54-pitch header

Function	Signal	PIN		Signal	Function
IDE LED	HDLED+	1	2	PWRLED+	Power LED
	HDLED-	3	4	N/C	
Reset	Reset+	5	6	PWRLED-	Speaker
	Reset-	7	8	SPK+	
N/C		9	10	N/C	
Power Button	PWRBT+	11	12	N/C	
	PWRBT-	13	14	SPK-	

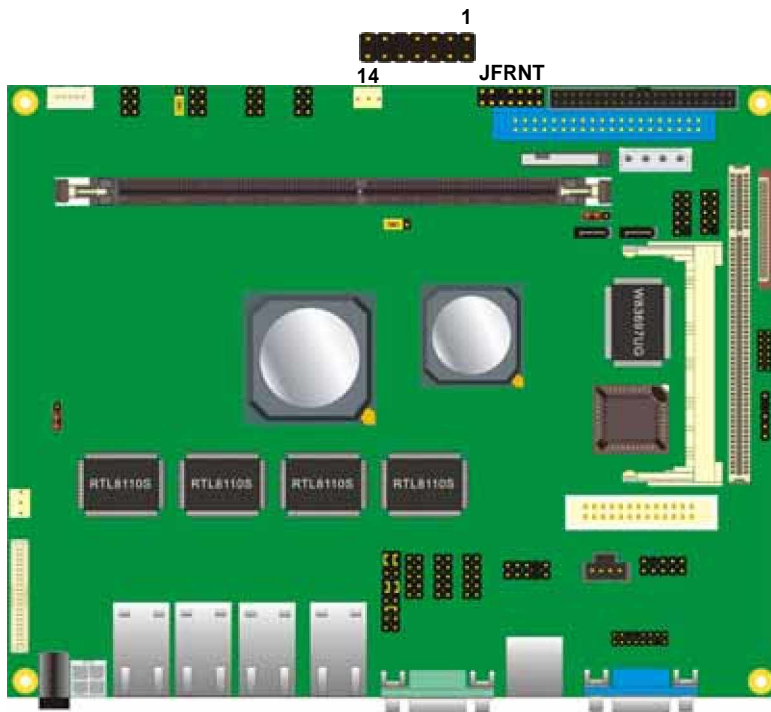

(This Page is Left For Blank)

Chapter 3 <System Configuration>

3.1 <SATA RAID Configuration>

The board supports two Serial ATA ports onboard, and supports RAID 0, 1 and JBOD disk array, the RAID 0, 1 and JBOD are specified below:

RAID 0 (Striping): Two hard drives operating as one drive for optimized data R/W performance. It needs two unused drives to build this operation.

RAID 1 (Mirroring): Copies the data from first drive to second drive for data security, and if one drive fails, the system would access the applications to the workable drive. It needs two unused drives or one used and one unused drive to build this operation. The second drive must be the same or larger size than first one.

JBOD (Span): As different as RAID 0, the JBOD combines two disks as one without any fault tolerance and I/O performance enhancement.

To build Serial ATA disk array, please press <TAB> while booting up the system before entering OS, and follow the instructions to edit the RAID function.

(Selectable Functions)

The screenshot shows the SATA RAID BIOS interface. The title bar reads "VIA Tech. UT8237 SATA RAID BIOS Ver 2.31". The main menu on the left lists several options: "Create Array" (highlighted), "Delete Array", "Create/Delete Spare", "Select Boot Array", and "Serial Number View". To the right of the menu, there is a text box with instructions: "Create a RAID array with the hard disks attached to VIA RAID controller", followed by a list of function keys: "F1 : View Array/disk Status", "f,l : Move to next item", "Enter: Confirm the selection", and "ESC : Exit". Below the menu and instructions is a table with the following data:

Channel	Drive Name	Array Name	Mode	Size(GB)	Status
Serial_Ch0	Master ST3120026AS	ARRAY 0	SATA	111.79	Boot
Serial_Ch1	Master Maxtor 6Y120W0	ARRAY 0	SATA	114.49	Boot

(Option Instruction)

(Disk Statement)

You also can edit disk array under OS, please install the VIA RAID Utility in the driver CD.

(To getting start, please click here to learn more information)

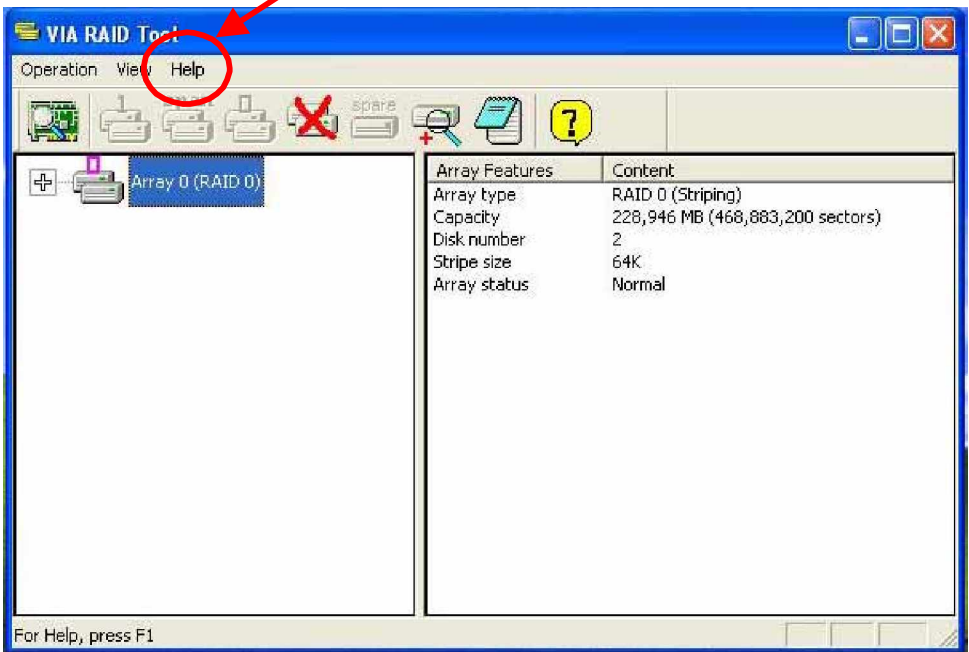

(Click here to build RAID 0)

(Click here to build RAID JBOD)

(Click here to build RAID 0)

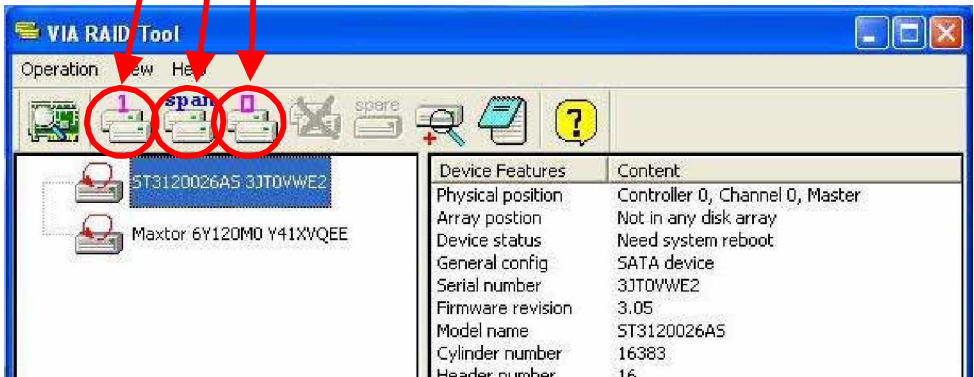

3.2 <Audio Configuration>

The board provides 5.1 channel audio interface with driver installed, please install the Realtek ALC655 audio driver in the CD before getting start to enjoy the 5.1 channel sound system.

3.3 <Display Configuration>

The board provides onboard analog VGA interface, and optional digital display interface with LVDS , please install the VIA video driver before enjoy the vivid display.

Based on the VIA CN700 with S3 UniChrome Pro graphic, the board provides dual display function for clone or extended desktop modes with secondary display device attached.

After installing video driver, please launch the desktop display properties.

For secondary display device, you have two options selectable.

or more display properties setting, please click "Advanced" button.

Please select S3Display for advanced device setting.

When you set dual display clone mode, you'll see the same screen display on two devices.

When you set the dual display for extended desktop mode, you can have the independent desktop on the second device.

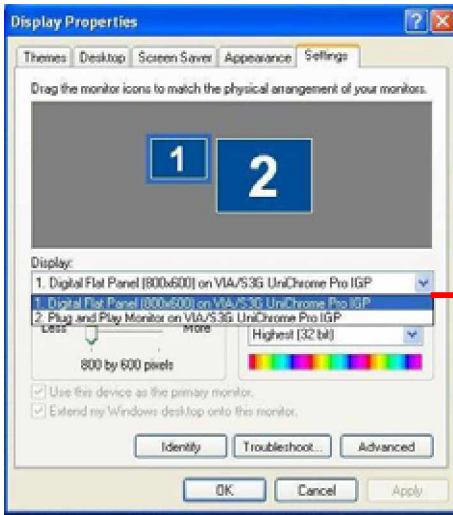

Two controllers for each display device



There are two options for secondary display device



For more display properties setting, please click "Advanced" button.

Please select S3Display for advanced device setting.

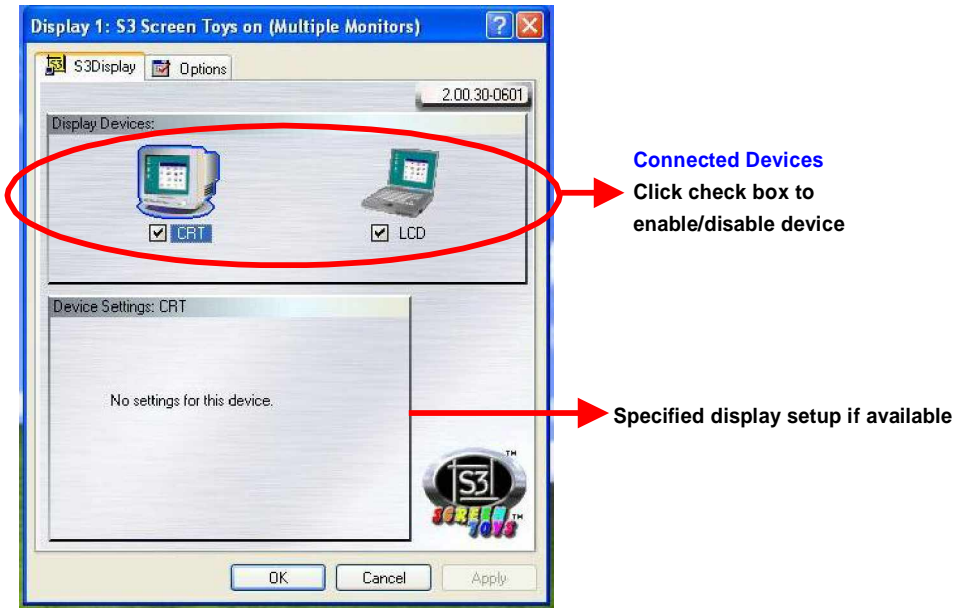

When you set dual display clone mode, you'll see the same screen display on two devices.



When you set the dual display for extended desktop mode, you can have the independent desktop on the second device.



(This Page is Left for Blank)

Chapter 4 <BIOS Setup>

The motherboard uses the Award BIOS for the system configuration. The Award BIOS in the single board computer is a customized version of the industrial standard BIOS for IBM PC AT-compatible computers. It supports Intel x86 and compatible CPU architecture based processors and computers. The BIOS provides critical low-level support for the system central processing, memory and I/O sub-systems.

The BIOS setup program of the single board computer let the customers modify the basic configuration setting. The settings are stored in a dedicated battery-backed memory, NVRAM, retains the information when the power is turned off. If the battery runs out of the power, then the settings of BIOS will come back to the default setting.

The BIOS section of the manual is subject to change without notice and is provided here for reference purpose only. The settings and configurations of the BIOS are current at the time of print, and therefore they may not be exactly the same as that displayed on your screen.

To activate CMOS Setup program, press **DEL** key immediately after you turn on the system. The following message "Press DEL to enter SETUP" should appear in the lower left hand corner of your screen. When you enter the CMOS Setup Utility, the Main Menu will be displayed as **Figure 4-1**. You can use arrow keys to select your function, press **Enter** key to accept the selection and enter the sub-menu.

Figure 4-1 CMOS Setup Utility Main Screen

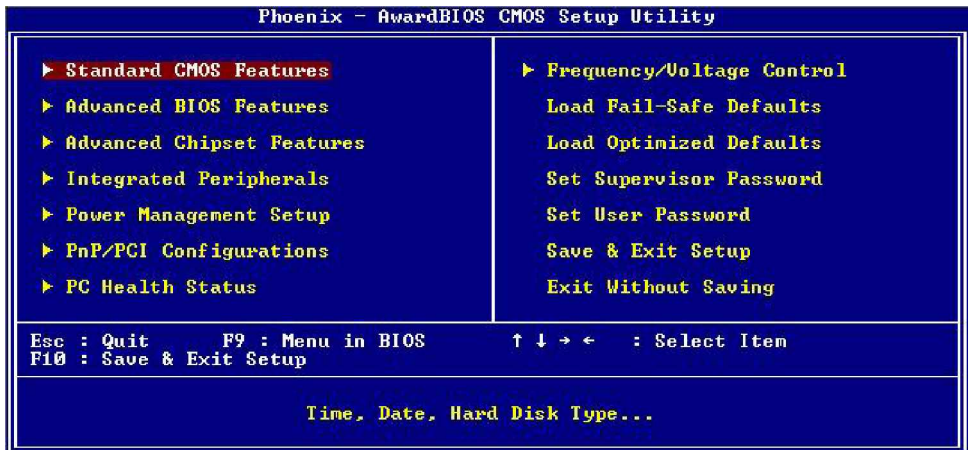

(This Page is Left for Blank)

Appendix A <I/O Port Pin Assignment>

A.1 <IDE Port>

Connector: IDE1

Type: 40-pin (20 x 2) box header



Pin	Description	Pin	Description
1	Reset	2	Ground
3	D7	4	D8
5	D6	6	D9
7	D5	8	D10
9	D4	10	D11
11	D3	12	D12
13	D2	14	D13
15	D1	16	D14
17	D0	18	D15
19	Ground	20	VCC
21	REQ	22	Ground
23	IOW-/STOP	24	Ground
25	IOR-/HDMARDY	26	Ground
27	IORDY/DDMARDY	28	IDESEL
29	DACK-	30	Ground
31	IRQ	32	N/C
33	A1	34	CBLID
35	A0	36	A2
37	CS0 (MASTER CS)	38	CS1 (SLAVE CS)
39	LED ACT-	40	Ground

Connector: IDE2

Type: 44-pin (22 x 2) box header



Pin	Description	Pin	Description
1	Reset	2	Ground
3	D7	4	D8
5	D6	6	D9
7	D5	8	D10
9	D4	10	D11
11	D3	12	D12
13	D2	14	D13
15	D1	16	D14
17	D0	18	D15
19	Ground	20	N/C
21	REQ	22	Ground
23	IOW-/STOP	24	Ground
25	IOR-/HDMARDY	26	Ground
27	IORDY/DDMARDY	28	Ground
29	DACK-	30	Ground
31	IRQ	32	N/C
33	A1	34	SD
35	A0	36	A2
37	CS1	38	CS3
39	ASP1	40	Ground
41	Vcc	42	Vcc
43	Ground	44	Ground

A.2 <Floppy Port>

Connector: **FDD**

Type: 26-pin connector



Pin	Description	Pin	Description
1	VCC	2	INDEX
3	VCC	4	DRV0
5	VCC	6	DSKCHG
7	DRV1	8	N/C
9	MTR1	10	MTR0
11	RPM	12	DIR
13	N/C	14	STEP
15	Ground	16	WRITE DATA
17	Ground	18	WRITE GATE
19	N/C	20	TRACK 0
21	N/C	22	WRPTR
23	Ground	24	RDATA-
25	Ground	26	SEL

A.3 <IrDA Port>

Connector: **CN_IR**

Type: 5-pin header for SIR Port



Pin	Description
1	Vcc
2	N/C
3	IRRX
4	Ground
5	IRTX

A.4 < CRT Port >

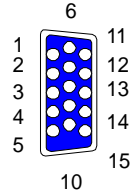

Connector: CRT

Type: 15-pin D-sub female connector on panel

	Description	Pin	Description	Pin	Description
1	RED	6	Ground	11	N/C
2	GREEN	7	Ground	12	5VCDA
3	BLUE	8	Ground	13	HSYNC
4	N/C	9	LVGA5V	14	VSYNC
5	Ground	10	Ground	15	5VCLK

A.5 <Serial ATA Port>

Connector: CN_SATA1/2

Type: 7-pin wafer connector

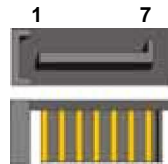

1	2	3	4	5	6	7
GND	RSATA_TXP1	RSATA_TXN1	GND	RSATA_RXN1	RSATA_RXP1	GND

A.6 <Serial Port>

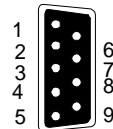

Connector: COM1

Type: 9-pin D-sub male connector on rear panel

Pin	Description	Pin	Description
1	DCD	6	DSR
2	SIN	7	RTS
3	SO	8	CTS
4	DTR	9	RI
5	Ground		

A.7 <LAN Port>

Connector: **RJ45_1/2/3/4**

Type: RJ45 connector with LED on rear panel

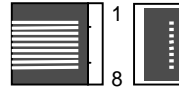

Pin	1	2	3	4	5	6	7	8
Description	TX+	TX-	RX+	N/C	N/C	RX-	N/C	N/C

Connector: **JLED0/1/2/3**

Type: 6-pin header for LAN LED



Pin	Description	Pin	Description
1	ACT+	2	ACT-
3	Link100+	4	Link100-
5	Link 1G+	6	Link 1G-

(This Page is Left for Blank)

Appendix B <Flash BIOS>

B.1 BIOS Auto Flash Tool

The board is based on Award BIOS and can be updated easily by the BIOS auto flash tool. You can download the tool online at the address below:

<http://www.award.com>

File name of the tool is "awdf flash.exe", it's the utility that can write the data into the BIOS flash ship and update the BIOS.

B.2 Flash Method

1. Please make a bootable floppy disk.
2. Get the last .bin files you want to update and copy it into the disk.
3. Copy awardflash.exe to the disk.
4. Power on the system and flash the BIOS. (Example: C:/ awardflash XXX.bin)
5. Re-star the system.

Any question about the BIOS re-flash please contact your distributors or visit the web-site at below:

<http://www.globalamericaninc.com>

(This Page is Left for Blank)

Any advice or comments about our products and service, or anything we can help you with please don't hesitate to contact with us. We will do our best to support you for your products, projects and business

Global American Inc.

Address: 17 Hampshire Drive
Hudson, NH 03051

TEL: Toll Free (U.S. Only) 800-833-8999
(603)886-3900

FAX: (603)886-4545

Website: <http://www.globalamericaninc.com>

E-Mail: salesinfo@globalamericaninc.com

