3307550

User's Manual Edition 1.0

Copyright

Copyright© 2002, 2003. All rights reserved. This document is copyrighted and all rights are reserved. The information in this document is subject to change without prior notice to make improvements to the products.

This document contains proprietary information and protected by copyright. No part of this document may be reproduced, copied, or translated in any form or any means without prior written permission of the manufacturer.

All trademarks and/or registered trademarks contains in this document are property of their respective owners.

Disclaimer

The Company shall not be liable for any incidental or consequential damages resulting from the performance or use of this product.

The Company does not issue a warranty of any kind, express or implied, including without limitation implied warranties of merchantability or fitness for a particular purpose.

The company has the right to revise the manual or include changes in the specifications of the product described within it at any time without notice and without obligation to notify any person of such revision or changes.

Trademark

All trademarks are the property of their respective holders.

Packing List

Hardware

3307550 CPU Card..... X 1

Cable Kit

IDE Flat Cable (40-pin) X 1

Floppy Cable..... X 1

DB9 COM / DB15 Parallel Port Cable with Bracket X 1

Dual USB Cable with Bracket X 2

PS/2 Keyboard and Mouse Cable..... X 1

Audio Cable with Bracket..... X 1

Printed Matter and Software

User's Manual X 1

Driver CD X 1

Table of Content

Chapter 1. Introduction	5
1.1 Product Overview	5
1.2 Specification	6
1.3 Component Placement	9
1.4 Block Diagram	10
Chapter 2. Hardware Setup	11
2.1 Jumper and Connector Location	11
2.2 CPU and DRAM Setting	14
2.3 CMOS Setting	14
2.4 Watchdog Timer Setting	15
2.5 Embedded Solid State Flash Disk	16
2.6 Power and Fan Connector	17
2.7 VGA Interface	18
2.8 Ethernet Interface	23
2.9 Audio Interface	24
2.10 Switches and Indicators	25
Chapter 3. BIOS Setup	27
3.1 Advanced Chipset Feature	28
3.2 Frame Buffer Size	29
3.3 Display Device	29
3.4 LCD Type	30
Chapter 4. Driver Installation	31

Appendix A. I/O Port Pin Assignment.....	33
A.1 IDE Port	33
A.2 Floppy Port.....	34
A.3 Parallel Port	35
A.4 RS-232 Serial Port.....	36
A.5 USB Port.....	37
A.6 IrDA Port	37
A.7 VGA Port.....	37
A.8 LAN Port	38
A.9 AT Keyboard Port.....	38
A.10 PS/2 Keyboard and Mouse Port.....	38
Appendix B. Flash the BIOS	39
B.1 BIOS Auto Flash Tool	39
B.2 Flash Method	39
Appendix C. System Resource.....	41
C.1 I/O Port Address Map.....	41
C.2 Memory Address Map	42
C.3 IRQ and DMA Resource.....	43

Chapter 1. Introduction

1.1 Product Overview

The **3307550** SBC (Single Board Computer) is an all-in-one industrial half-size PISA CPU card based on Intel socket 370 architecture, supports Intel Tualatin/Coppermine FC-PGA II, FC-PGA Pentium-III / Celeron and VIA C3 CPU up to 1.4 GHz at 66, 100, 133 MHz of FSB with PC100/133 SDRAM. Based on the value VIA/S3 Twister-T chipset with VIA PN133T northbridge and 686B southbridge, the FS-961 supports the Intel and VIA latest socket 370 based CPU, 1 GBytes PC133 SDRAM and VIA/S3 Savage4 3D SVGA core with BIOS selectable 8/16/32 MB video memory shard with system memory.

To be the requirement of multi-media computing platform, the **3307550** also offers the 18-bit dual-channel LVDS/TTL TFT/DSTN LCD interface. The onboard Fast Ethernet, audio and CompactFlash interfaces also offer the features for the industrial PC, server and workstation, portable workstation, node terminal, transaction station and industrial embedded application.

With these features, **3307550** should be the value, powerful and all-in-one integration solution including, but not limited to the following.

Value Advanced Computing Platform

Intel latest Tualatin Pentium-III / Celeron and VIA C3 CPU up to 1.4 GHz with 133 MHz FSB, 1GBytes PC133 SDRAM of system memory for high-end industrial computing platform with high CPU and memory loading.

LVDS/TTL TFT/DSTN LCD Interface

VIA/S3 Twister-T integrated S3 Savage4 3D SVGA core, BIOS selectable 8/16/32 MB of video memory shared with system memory, and 18-bit dual-channel LVDS / TTL TFT/DSTN LCD interface offers the value and performance solution for the LCD-based multi-media applications.

Solid State Disk Interface

Onboard CompactFlash socket supports CFC (CompactFlash Card) up to 1 GBytes of flash memory capacity. The onboard IDE port with jumper selectable power input also supports power cable free IDE-based DOM (DiskOnModule) and M-systems DiskOnChip IDE Pro SSD (Solid State Disk) for disk free and embedded OS based application.

1.2 Specification

General Specification

Form Factor	Half-size PISA-bus CPU Card / Slot PC
CPU	Socket 370 Intel Pentium-III / Celeron, VIA C3 CPU Up to 1.4 GHz at 66/100/133 MHz of FSB Intel Tualatin / Coppermine FC-PGA2 / FC-PGA CPU and VIA C3 Samuel I/II, Ezra, Nehemiah CPU
Chipset	VIA Twister-T chipset with PN133T and 686B
Memory	One 144-pin SO-DIMM sockets support up to 1 GBytes of PC100/133 SDRAM
BIOS	Phoenix-Award 2Mb PnP flash BIOS
Enhanced IDE	PCI enhanced IDE interface supports dual ports up to 4 ATAPI devices with UltraATA/100 supported Jumper selectable Vcc power output on IDE2 for power cable free DOM (DiskOnModule) flash disk
Green Function	Power saving mode supported in BIOS with DOZE, STANDBY and SUSPEND modes. ACPI version 1.0 and APM version 1.2 compliant
Watchdog Timer	6-level generates NMI or system reset programmable watchdog timer
Real Time Clock	VIA 686B built-in RTC with onboard lithium battery

Multi-I/O Port

Chipset	VIA 686B chipset built-in super I/O controller
Serial Port	Two RS-232 serial ports with 16C550 compatible UART and 16 bytes FIFO
Parallel Port	One bi-direction parallel port with SPP/ECP/EPP mode
USB Port	Four USB ports with USB version 1.1 compliant
Floppy Port	One floppy port supports up to two FDD
IrDA Port	One IrDA compliant Infrared interface supports SIR
AT Keyboard	One AT keyboard port
K/B & Mouse	PS/2 keyboard and mouse port

Solid State Disk Interface

Flash Type	CompactFlash socket for CFC (CompactFlash Card) IDE-based DOM (DiskOnModule) and M-systems DiskOnChip IDE Pro
Capacity	32M to 1GBytes of flash memory for CFC 16M to 512 MBytes of flash memory for DOM
Transfer Rate	PIO mode 4 up to 16.6 MBytes/sec.
Mode Selection	Jumper selectable Master / Slave mode on primary IDE port for CFC (CompactFlash Card) Jumper selectable +5V Vcc power input for power cable free DOM on secondary IDE port

VGA Interface

Chipset	VIA/S3 Twister-T PN133T chipset built-in S3 Savage4 SVGA controller with 128-bit 3D/2D engine
Video Memory	BIOS selectable 8/16/32 MBytes of video memory shared with system memory
Display Type	CRT and LCD monitor LVDS/TTL TFT/DSTN Color LCD
CRT Mode	VGA, SVGA, XGA, SXGA, UXGA Up to 1920 x 1440 of resolution for CRT monitor
LCD Mode	36-bit TFT/DSTN LCD interface with 256 gray shade Integrated 2-channel 110 MHz LVDS interface Support up to 1280 x 1024 of resolution
CRT Connector	External DB15 female connector on bracket Internal 16-pin header connector onboard
LCD Connector	Onboard 50-pin header connector for TTL LCD Onboard 2 x 20-pin Hirose DF13-20DP-1.25V for LVDS

Audio Interface

Chipset	VIA 686B built-in AC97 3D audio controller with codec
Interface	Line-in, line-out, Mic-in and CD-in
Connector	Onboard 10-pin header for line-in, line-out and Mic-in Onboard 4-pin header for CD-in

Power and Environment

Power Req.	+5V, +12V DC input +5V @ 4.2A typically with Intel Socket 370 FC-PGA Pentium-III 866 MHz CPU and 128 MB PC133 SDRAM
ATX Function	One 3-pin ATX interface with PS-ON and 5V standby
Dimension	185 x 127 mm (L x H)
Weight	0.37 Kg for board only; 1.18 Kg with standard package
Temperature	Operating within 0 ~ 60°C (32 ~ 140°F) Storage within -20 ~ 85°C (-4 ~ 185°F)

Ordering Code

3307550	Half-size PISA bus CPU Card with Socket 370 CPU, VGA, LVDS, Audio, LAN, PC/104 and Compact Flash interface.
----------------	---

1.3 Component Placement

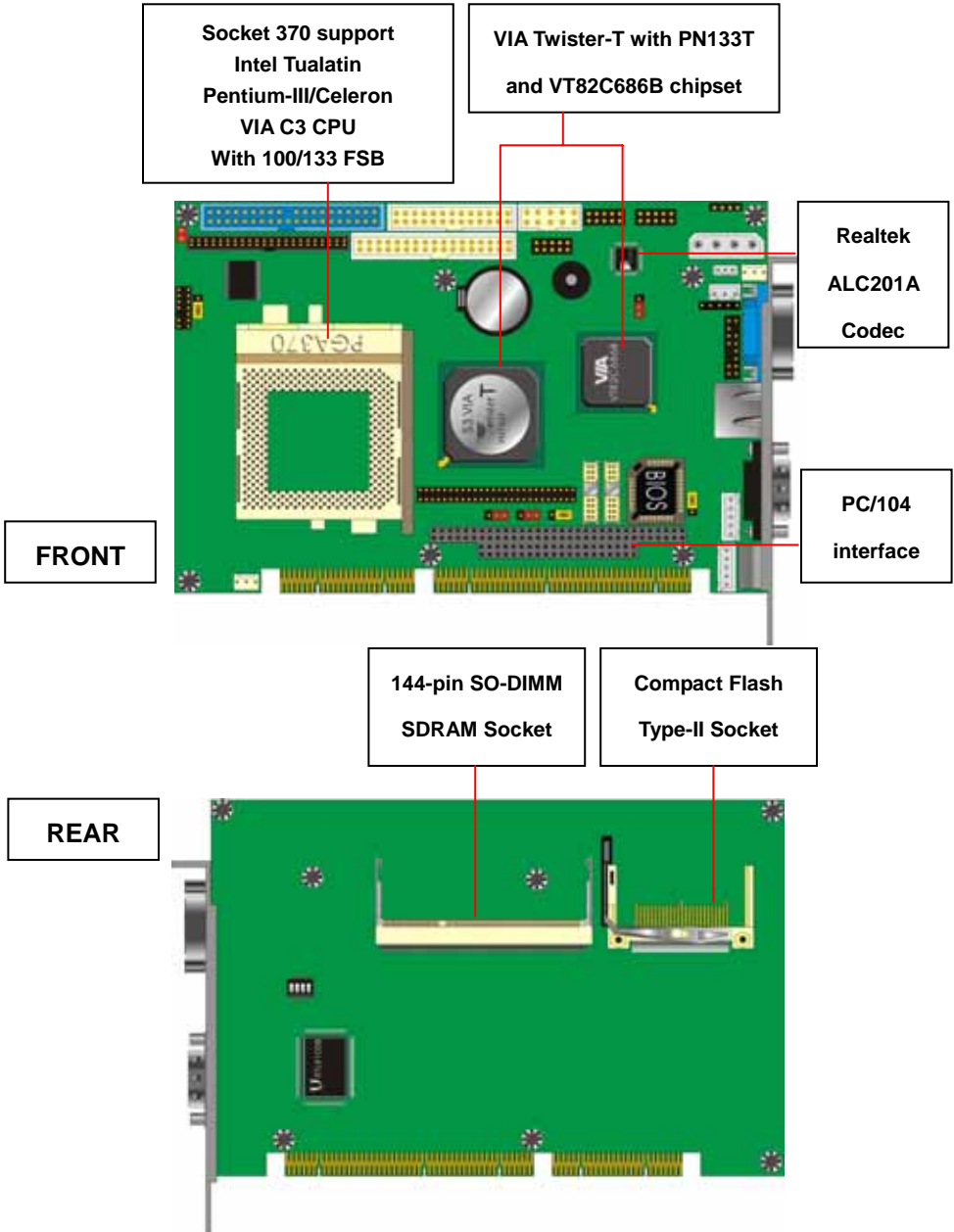

1.4 Block Diagram

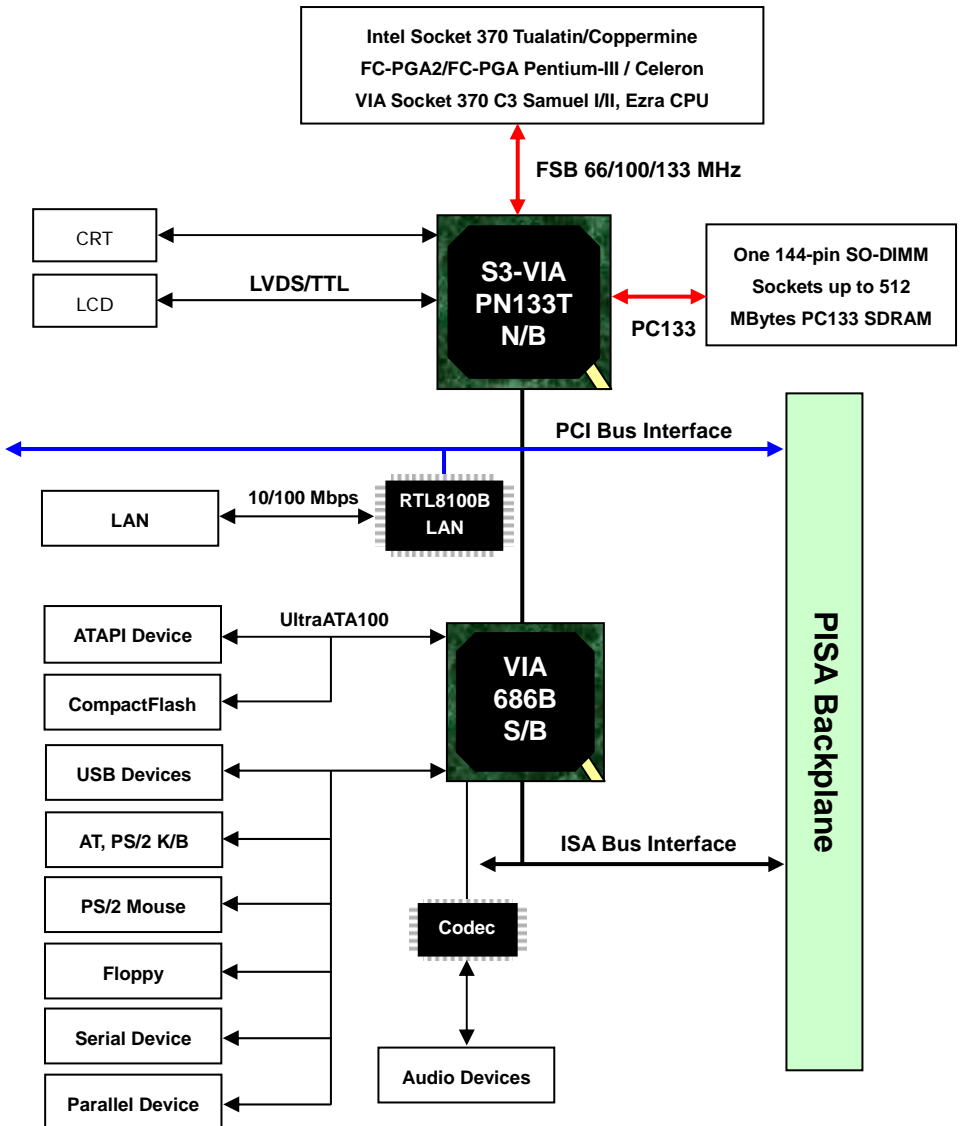

Chapter 2. Hardware Setup

This chapter contains the information for the installation of hardware. The install procedure includes jumper settings, CPU and memory installation, fan, I/O and panel connections.

2.1 Jumper and Connector Location

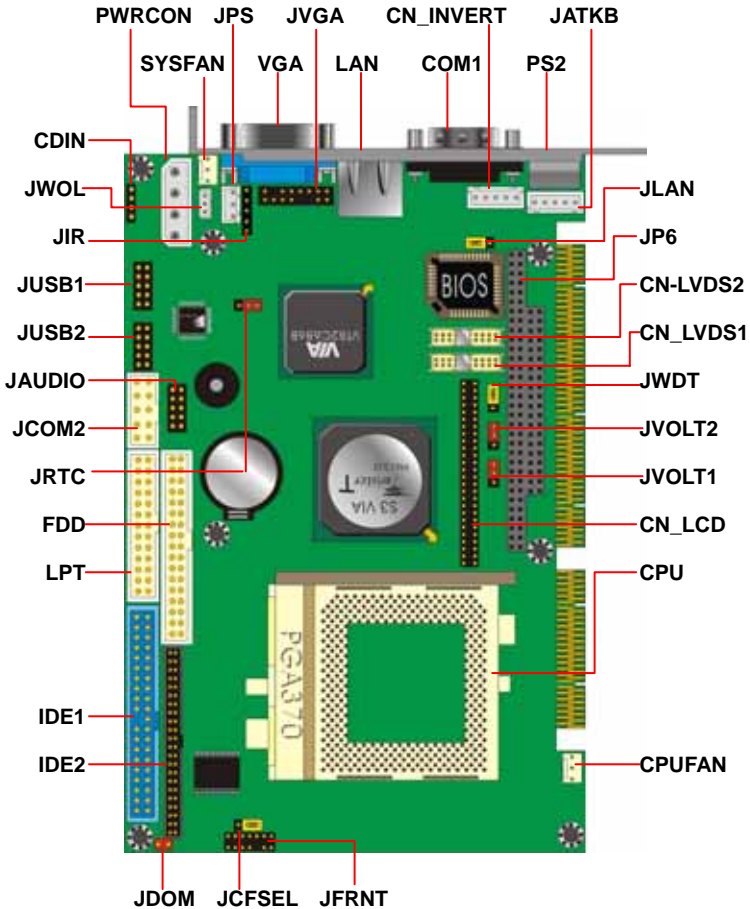

2.1.1 Jumper Reference

Jumper	Function	Section
JRTC	CMOS Setting	2.3
JWDT	Watchdog Timer Mode Setting	2.4
SWDT	Time Out Value of Watchdog Timer Setting	2.4
JCFSEL	CompactFlash Card (CFC) Mode Setting	2.5.1
JDOM	DiskOnModule (DOM) Power Setting	2.5.2
JVOLT1	Flat Panel's Voltage Setting	2.7.2
JVOLT2	Flat Panel's Power Setting	2.7.2
JLAN	LAN Enable/Disable Setting	2.8

2.1.2 Connector Reference

Internal Onboard Connector

Connector	Function	Remark
CPU	CPU Socket PGA370	Standard
DIMM	144-pin SO-DIMM Socket	Standard
IDE1	40-pin Primary IDE Port	Standard
IDE2	44-pin Secondary IDE Port	Standard
FDD	34-pin Floppy Port	Standard
LPT (PRINTER)	26-pin Parallel Port	Standard
JUSB1	10-pin 1st / 2nd USB Port	Standard
JUSB2	10-pin 3rd / 4th USB Port	Standard
JCOM2	10-pin COM2 RS232 Serial Port	Standard
CF	CompactFlash Socket	Standard
JATKB	5-pin AT Keyboard Connector	Standard
SIR	5-pin SIR IrDA Port	Standard
PWRCON	6-pin AT/P8 Power Connector	Standard
JPS	3-pin ATX Signal Connector	Standard
JFRNT	14-pin Front Panel Connector	Standard
CPUFAN	3-pin CPU Fan Connector	Standard
SYSFAN	3-pin System Fan Connector	Standard
JVGA	16-pin Internal VGA Port	Standard
JAUDIO	10-pin Audio Port	Standard
CDIN	4-pin CD-in Interface	Standard
JWOL	3-pin Wake-On-LAN Connector	Standard
CN_INVERT	5-pin Backlight Inverter power connector	Standard
JLCD	50-pin TTL LCD Interface	Standard
JLVDS1/2	20-pin LVDS LCD Interface	Standard

External Connector on Bracket

Connector	Function	Remark
VGA	DB15 Female VGA Connector	Standard
LAN	RJ45 LAN Connector with LED	Standard
COM1	DB9 Male COM1 Connector	Standard
PS2	6-pin MiniDIN PS/2 Keyboard & Mouse	Standard

2.2 CPU and DRAM Setting

The board is based on Intel socket 370 Pentium-III / Celeron architecture supports Intel FC-PGA and VIA C3 CPUs at 66/100/133 MHz of FSB. The FSB, ratio and voltage of CPU is default set by CPU without any additional jumper selection. The CPU should be installed into the CPU ZIF socket.

The board supports PC100/133 SDRAM up to 512MBytes of memory capacity on One 144-pin SO-DIMM sockets.

2.3 CMOS Setting

The board's data of CMOS can be setting in BIOS. If the board refuses to boot due to inappropriate CMOS settings, here is how to proceed to clear (reset) the CMOS to its default values.

Jumper: **JRTC**

Type: onboard 3-pin header

JRTC	Mode
1-2	Clear CMOS
2-3	Normal Operation

Default setting

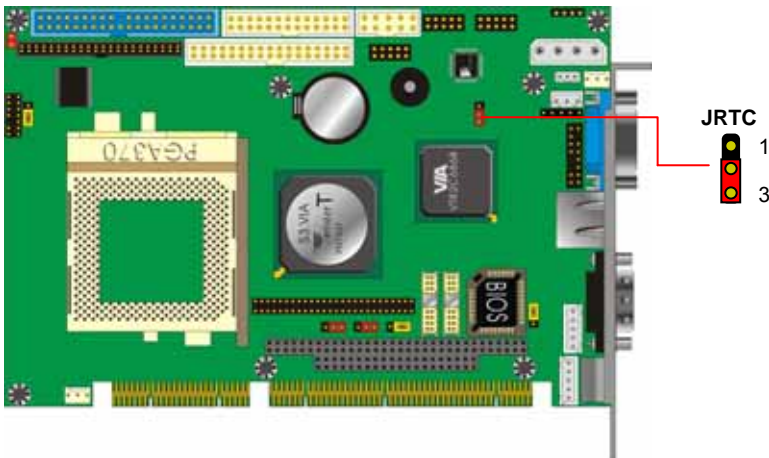

2.4 Watchdog Timer Setting

The watchdog timer makes the systems auto-reset while it stop to work for a period. The onboard watchdog timer can be set as system reset or active NMI mode by jumper JWDT; the timeout value can be set as 1, 2, 10, 20, 110, or 220 seconds by jumper SWDT.

Jumper: **JWDT**

Type: onboard 3-pin header

JWDT	Watchdog Timer
1-2	Active NMI
2-3	Reset

Default setting

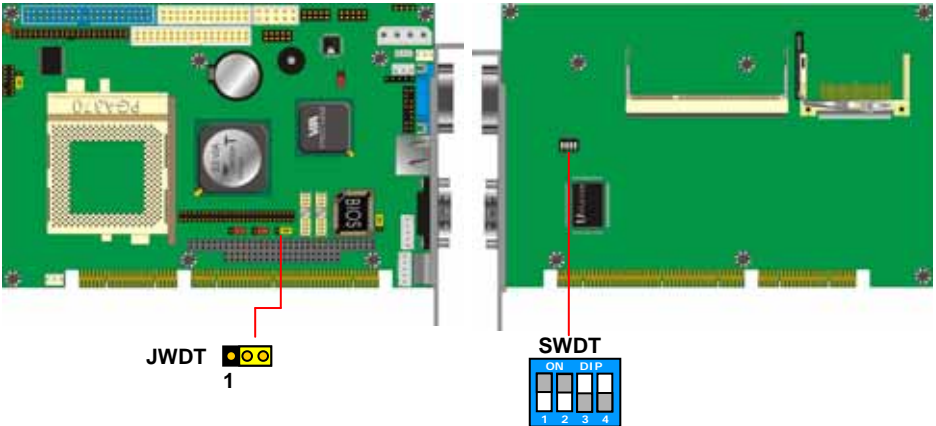

Jumper: **SWDT**

Type: onboard 4-button / 2-level DIP switch

Timeout Value	SWDT	1	2	3	4
1 Second		OFF	OFF	ON	OFF
2 Seconds		OFF	OFF	ON	ON
10 Seconds		OFF	ON	OFF	OFF
20 Seconds		OFF	ON	OFF	ON
110 Seconds		ON	OFF	OFF	OFF
220 Seconds		ON	OFF	OFF	ON

Default setting

2.5 Embedded Solid State Flash Disk

The board supports both of CompactFlash and DOM (DiskOnModule) embedded flash disk. The onboard CompactFlash socket supports the IDE-based, driver free and bootable CFC (CompactFlash Card) with jumper selectable Master / Slave mode on primary IDE channel. The IDE port also supports DOM (DiskOnModule) or M-systems DiskOnChip IDE Pro flash disk with jumper selectable Vcc power input for power cable free DOM on secondary IDE port.

2.5.1 CompactFlash Mode Setting

Jumper: **JCFSEL**

Type: onboard 3-pin header

JCFSEL	CompactFlash Mode (IDE1)
1-2	Master
2-3	Slave

Default setting

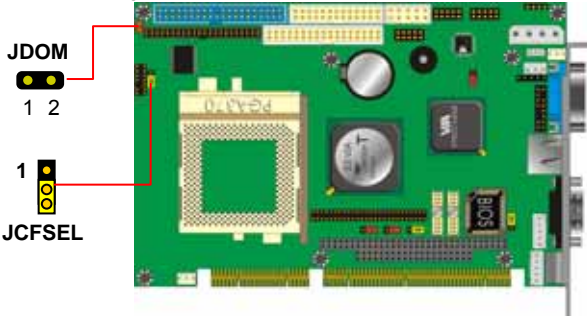

2.5.2 DiskOnModule or DiskOnChip 2000 IDE Pro

Jumper: **JDOM**

Type: onboard 2-pin header

JDOM	DiskOnModule Power Setting
OFF (Open)	Normal (without Vcc on pin-20 of IDE2)
ON (Close)	DOM (with Vcc on pin-20 of IDE2)

Default setting

2.6 Power and Fan Connector

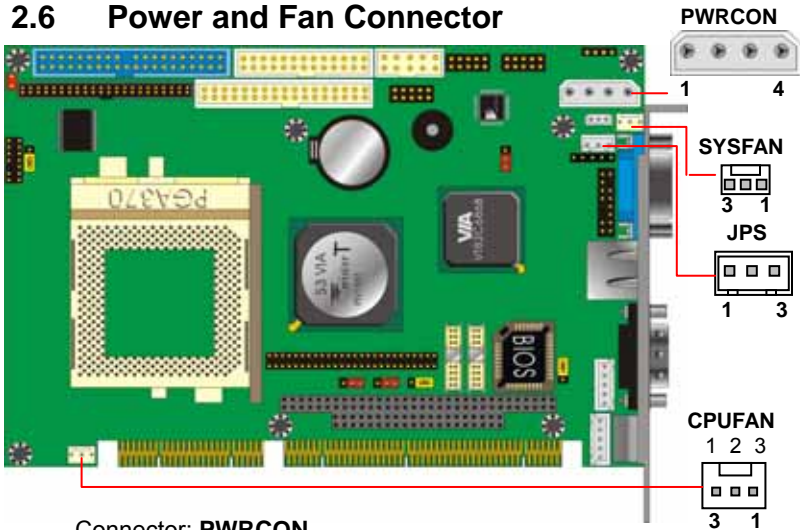

Connector: **PWRCON**

Type: 4-pin AT power connector

Pin	Description
1	+5V
2	GND
3	GND
4	+12V

Connector: **JPS**

Type: 3-pin ATX function connector

Pin	Description	Pin	Description	Pin	Description
1	5V Standby	2	Ground	3	Power On

Connector: **CPUFAN, SYSFAN**

Type: 3-pin fan power wafer connector

Pin	Description	Pin	Description	Pin	Description
1	Ground	2	+12V	3	Fan Control

2.7 VGA Interface

2.7.1 Standard Analog VGA Interface

The board is integrated with VIA/S3 Twister-T PN133T chipset built-in S3 Savage4 3D SVGA core with BIOS selectable 8/16/32 MBytes video memory shared with system memory.

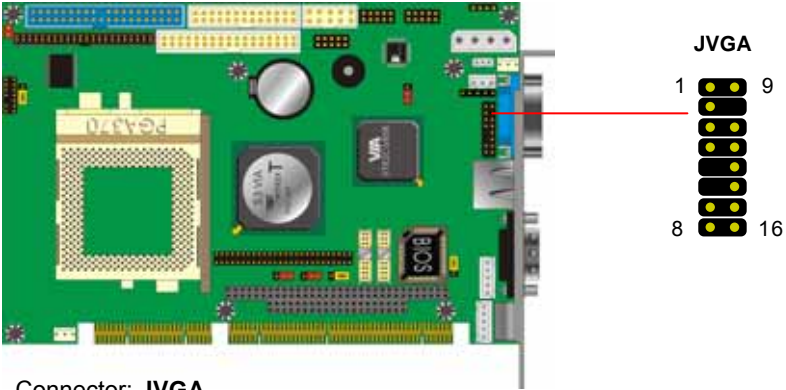

Connector: **JVGA**

Type: 16-pin (2 x 8) 2.54-pitch pin header

Pin	Description	Pin	Description
1	Red	9	Green
2	Blue	10	N/C
3	Ground	11	Ground
4	Ground	12	Ground
5	N/C	13	Ground
6	N/C	14	Data
7	HSYNC	15	VSYNC
8	Clock	16	N/C

2.7.2 Digital VGA Interface

The board provides the LCD Interface with VIA/S3 Twister-T PN133T chipset built-in S3 Savage4 VGA controller and 18-bit Dual-channel LVDS / TTL interface for TFT and DSTN LCD panel.

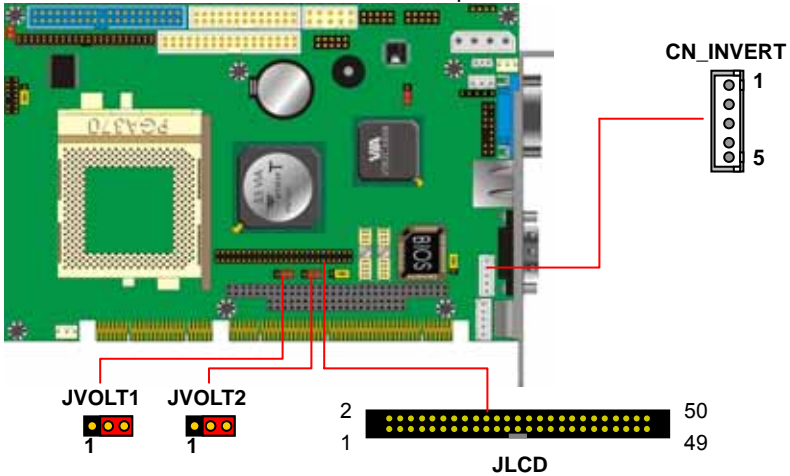

Jumper: **JVOLT1**
Type: onboard 3-pin header

JVOLT1	LCD Voltage Setting
1-2	+5V
2-3	+3.3V

Default setting

Jumper: **JVOLT2**
Type: onboard 3-pin header

JVOLT2	LCD Power Sequence Control
1-2	Power Input Directly
2-3	Power Sequence Control by Chipset

Default setting

TTL TFT/DSTN LCD Interface

Connector: **CN_LCD**

Type: onboard 50-pin (2 x 25) 2.0-pitch pin header

Pin	Signal	Pin	Signal
1	ENAVDD	2	ENAVEE
3	GND	4	GND
5	V _{CC} (LCD)	6	V _{CC} (LCD)
7	GND	8	GND
9	P0	10	P1
11	P2	12	P3
13	P4	14	P5
15	P6	16	P7
17	P8	18	P9
19	P10	20	P11
21	P12	22	P13
23	P14	24	P15
25	P16	26	P17
27	P18	28	P19
29	P20	30	P21
31	P22	32	P23
33	P24	34	P25
35	SHFCLK	36	FLM
37	M	38	LP
39	GND	40	GND
41	P26	42	P27
43	P28	44	P29
45	P30	46	P31
47	P32	48	P33
49	P34	50	P35

LVDS TFT/DSTN LCD Interface

Connector: **JLVDS1, JLVDS2**

Type: onboard 20-pin Hirose DF13-20DP-1.25V

Pin	Signal	Pin	Signal
1	LCD_Vcc	2	LCD_Vcc
3	GND	4	GND
5	TX0-	6	TX0+
7	GND	8	TX1-
9	TX1+	10	GND
11	TX2-	12	TX2+
13	GND	14	TCLK-
15	TCLK+	16	GND
17	N/C	18	N/C
19	GND	20	GND

LCD Backlight Inverter Power Connector

Connector: **CN_INVERT**

Type: 5-pin wafer connector

Pin	Description
1	+12V
2	Ground
3	Ground
4	Ground
5	ENABKL

BIOS Configuration for LCD

The selection of display type for flat panel depends on the LCD display you use. Please enter the “Advanced Chipset Features” screen on the main screen and find the item of “Panel Type”, and set it with the specification of the flat panel.

LCD Type	Support LCD
00	640x480 TFT
01	800x600 TFT
02	1024x768TFT 2 pixel/clock at 32MHz
03	1280x1024 TFT
04	640x480 DSTN
05	800x600 DSTN
06	1024x768 DSTN
07	1024x768 TFT 1 pixel/clock at 65MHz
08	640x480 TFT
09	800x600 TFT
0A	1024x768 TFT
0B	1280x1024 TFT / Pixel
0C	1400x1050 TFT
0D	800x600 DSTN
0E	1024x768 DSTN
0F	1280x1024 DSTN

Default setting

2.8 Ethernet Interface

The board integrated with 10/100BASE-TX Fast Ethernet interface at the type of 10Base-T/100Base-TX auto-switching Fast Ethernet with full duplex and IEEE 802.3U compliant. The LAN controller, RTL8100B provides the powerful Fast Ethernet interface with embedded operating system (OS) supported, green function (power saving mode / wake-on-LAN) and advanced network management functions.

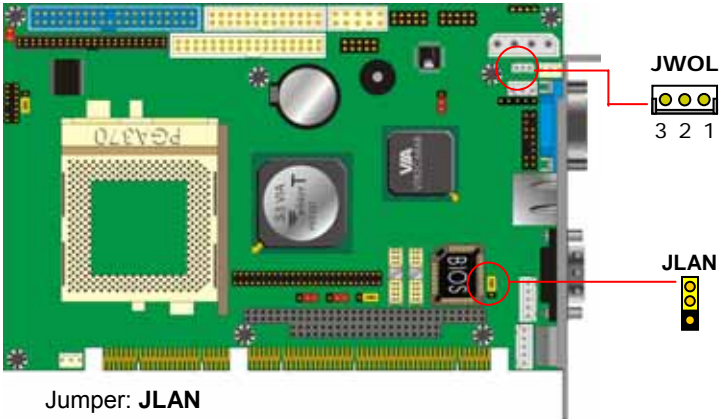

Jumper: **JLAN**
Type: onboard 3-pin header

JLAN	LAN Interface
1-2	Enable
2-3	Disable
Default setting	

Connector: **JWOL**
Type: onboard 3-pin header wafer connector

Pin	1	2	3
Description	+5V Standby	Ground	WOL-Ctrl

2.9 Audio Interface

The board integrates with AC97 3D audio interface VIA 686B with Realtek ALC201A code that provides line-in, line-out, Mic-in and CD-in interfaces for industrial applications with audio function.

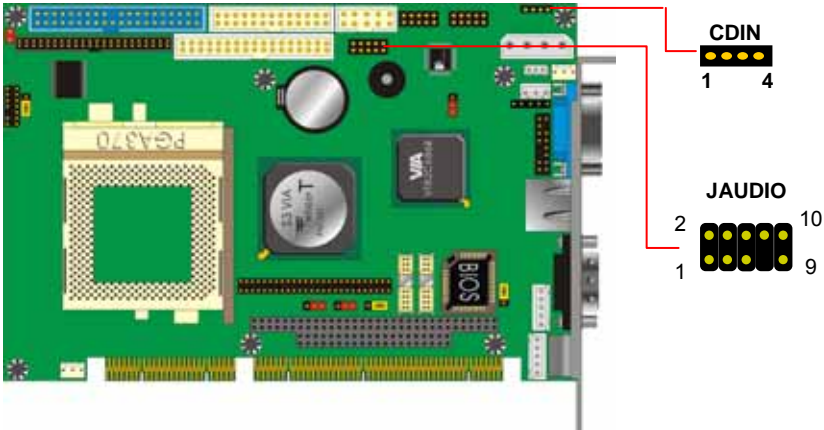

Connector: **JAUDIO**

Type: 10-pin (2 x 5) 2.54-pitch pin header

Pin	Description	Pin	Description
1	Line – Right	2	Ground
3	Line – Left	4	MIC
5	MIC	6	Ground
7	N/C	8	Line Out – Left
9	Line Out – Right	10	Ground

Connector: **CDIN** (CD Audio Input Interface)

Type: 4-pin (1 x 4) 2.54-pitch wafer connector

Pin	Description
1	CD – LEFT
2	Ground
3	Ground
4	CD – RIGHT

2.10 Switch and Indicator

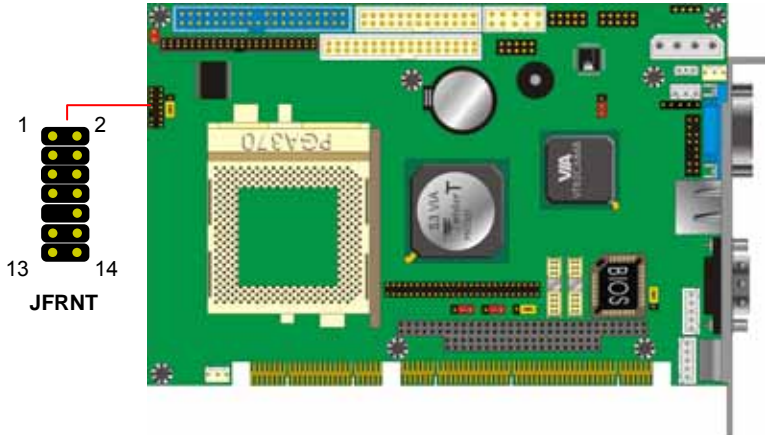

Connector: **JFRNT**

Type: onboard 14-pin (2 x 7) 2.54-pitch pin header

Function	Signal	PIN		Signal	Function	
IDE LED	Vcc (+)	1		2	(+) Vcc	Power LED
	Active	3		4	N/C	
Reset	Reset	5		6	GND	
	GND	7		8	Vcc	Speaker
N/C		9		10	N/C	
Power	PWRBT	11		12	N/C	
Button	GND	13		14	SPKIN	

Notes (This page left blank intentionally)

A large, empty rectangular box with a thin black border, occupying most of the page. It is intended for the user to write notes.

Chapter 3. BIOS Setup

The single board computer uses the Award BIOS for the system configuration. The Award BIOS in the single board computer is a customized version of the industrial standard BIOS for IBM PC AT-compatible computers. It supports Intel x86 and compatible CPU architecture based processors and computers. The BIOS provides critical low-level support for the system central processing, memory and I/O sub-systems.

The BIOS setup program of the single board computer let the customers modify the basic configuration setting. The settings are stored in a dedicated battery-backed memory, NVRAM, retains the information when the power is turned off. If the battery runs out of the power, then the settings of BIOS will come back to the default setting.

The BIOS section of the manual is subject to change without notice and is provided here for reference purpose only. The settings and configurations of the BIOS are current at the time of print, and therefore they may not be exactly the same as that displayed on your screen.

To activate CMOS Setup program, press < DEL > key immediately after you turn on the system. The following message “Press DEL to enter SETUP” should appear in the lower left hand corner of your screen. When you enter the CMOS Setup Utility, the Main Menu will be displayed as **Figure 3-1**. You can use arrow keys to select your function, press < Enter > key to accept the selection and enter the sub-menu.

Figure 3-1. CMOS Setup Utility Main Screen

Phoenix – Award BIOS CMOS Setup Utility

>Standard CMOS Features	>Frequency/Voltage Control
>Advanced BIOS Features	Load Fail-Safe Defaults
>Advanced Chipset Features	Load Optimized Defaults
>Integrated Peripherals	Set Supervisor Password
>Power Management Setup	Set User Password
>PnP / PCI Configurations	Save & Exit Setup
>PC Health Status	Exit Without Saving
Esc : Quit	↑ ↓ → ← : Select Item
F10 : Save & Exit Setup	

3.1 Advanced Chipset Feature

The display interface of the board can be setup in the BIOS with the selections including the video memory, display type and LCD type. In the section of “Advanced Chipset Features” on the main screen, there are three items of “Frame Buffer Size”, “Display Device” and “LCD Type” to set the capacity of video memory, display device and specification of the flat panel.

Figure 3.2 - Advanced Chipset Features Screen

Phoenix – Award BIOS CMOS Setup Utility
Advanced Chipset Features

DRAM Timing By SPD	[Enabled]	Item Help
X DRAM Clock	[Host CLK]	
X SDRAM Cycle Length	3	Menu Level ►
X Bank Interleave	[Disabled]	
Memory Hole	[Disabled]	
P2C/C2P Concurrency	[Enabled]	
System BIOS Cacheable	[Enabled]	
Video RAM Cacheable	[Enabled]	
Frame Buffer Size	[16M]	
AGP Aperture Size	[64M]	
AGP-4X Mode	[Enabled]	
AGP Driving Control	[Auto]	
AGP Driving Value	DA	
Display Device	[CRT]	
LCD Type	07	
OnChip USB	[Enabled]	
USB Keyboard Support	[Disabled]	
USB Mouse Support	[Disabled]	
OnChip Sound	[Auto]	
CPU to PCI Write Buffer	[Enabled]	
PCI Dynamic Bursting	[Enabled]	
PCI Master 0 WS Write	[Enabled]	
PCI Delay Transaction	[Disabled]	
PCI#2 Access #1 Retry	[Disabled]	
AGP Master 1 WS Write	[Disabled]	
AGP Master 1 WS Read	[Disabled]	

↑ ↓ → ← : Move Enter : Select +/- / PU / PD : Value F10 : Save ESC : Exit F1 : General Help
 F5 : Previous Value F6 : Fail-Safe Defaults F7 : Optimized Defaults

3.2 Frame Buffer Size

The item of “Frame Buffer size” offers the selection of the capacity of video memory shared with system memory including 2, 4, 8, 16, and 32 MBytes.

Selection	Frame Buffer Size
2M	2 MBytes of Video Memory
4M	4 MBytes of Video Memory
8M	8 MBytes of Video Memory
16M	16 MBytes of Video Memory
32M	32 MBytes of Video Memory

Default Setting

3.3 Display Device

The item of “Display Device” offers the selection of the display type. The selections include Auto, CRT, LCD, CRT+LCD.

Selection	Support Display Type
Auto	Auto Detect
CRT	CRT Display
LCD	LCD Panel
CRT+LCD	Both of CRT and LCD Panel

Default Setting

Please notice that if the systems are connecting with the KVM data switch, the selection of display device should be “CRT” or “CRT+LCD” because the system will detect the display every time when you change the channel of the KVM data w/switch if it's setting as “auto”.

3.4 LCD Type

The item of “LCD Type” offers the selection of the LCD type. Please check the LCD you want to use and select the right LCD type, saving and restart the computer.

LCD Type	Support Function
00	640x480 TFT
01	800x600 TFT
02	1024x768TFT 2pixel/clock at 32Mhz
03	1280x1024 TFT
04	640x480 DSTN
05	800x600 DSTN
06	1024x768 DSTN
07	1024x768 TFT 1pixel/clock at 65Mhz
08	640x480 TFT
09	800x600 TFT
0A	1024x768 TFT
0B	1280x1024 TFT
0C	1400x1050 TFT 2pixel/clock at 54Mhz
0D	800x600 DSTN
0E	1024x768 DSTN
0F	1280x1024 DSTN

Default Setting

Chapter 4. Driver Installation

The driver CD offers auto-run menu. It will detect and select the type of single board computer and helps you install the drivers automatically.

Install Related Chipset INF Driver

The selection helps you to install the INF of related chipset interface.

Install VGA Driver

The selection helps you to install the driver of onboard VGA interface.

Install LAN Driver

The selection helps you to install the driver of onboard LAN interface.

Install Audio Driver

The selection helps you to install the driver of onboard audio interface.

Link to < Website > Homepage

The selection helps you to link to the website to find the updated technical documents and download directly.

Browse this CD

The selection helps you to find the drivers in this CD directly.

Notes (This page left blank intentionally)

A large, empty rectangular box with a thin black border, occupying most of the page. It is intended for the user to write notes.

Appendix A. I/O Port Pin Assignment

A.1 IDE Port

Connector: **IDE1, IDE2**
Type: 40-pin box header

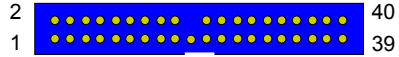

Pin	Description	Pin	Description
1	Reset	2	Ground
3	D7	4	D8
5	D6	6	D9
7	D5	8	D10
9	D4	10	D11
11	D3	12	D12
13	D2	14	D13
15	D1	16	D14
17	D0	18	D15
19	Ground	20	N/C (Vcc) *
21	REQ	22	Ground
23	IOW-/STOP	24	Ground
25	IOR-/HDMARDY	26	Ground
27	IRDY/DDMARDY	28	IDESEL
29	DACK-	30	Ground
31	IRQ	32	N/C
33	A1	34	CBLID
35	A0	36	A2
37	CS0 (MASTER CS)	38	CS1 (SLAVE CS)
39	LED ACT-	40	Ground

* Jumper selectable Vcc power on IDE2 port for power cable free DOM (DiskOnModule).

A.2 Floppy Port

Connector: **FDD**

Type: 34-pin (2x 17) 2.54-pitch box header

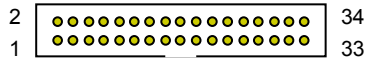

Pin	Description	Pin	Description
1	Ground	2	DRIVE DENSITY SELECT 0
3	Ground	4	DRIVE DENSITY SELECT 1
5	Ground	6	N/C
7	Ground	8	INDEX-
9	Ground	10	MOTOR ENABLE A-
11	Ground	12	DRIVER SELECT B-
13	Ground	14	DRIVER SELECT A-
15	Ground	16	MOTOR ENABLE B-
17	Ground	18	DIRECTION-
19	Ground	20	STEP-
21	Ground	22	WRITE DATA-
23	Ground	24	WRITE GATE-
25	Ground	26	TRACK 0-
27	Ground	28	WRITE PROTECT-
29	Ground	30	READ DATA-
31	Ground	32	HEAD SELECT-
33	Ground	34	DISK CHANGE-

A.3 Parallel Port

Connector: **LPT (PRINTER)**

Type: 26-pin (2 x 13) 2.54-pitch box header

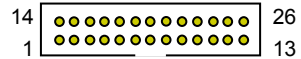

Pin	Description	Pin	Description
1	STROBE-	14	AUTO FEED-
2	D0	15	ERROR-
3	D1	16	INITIALIZE-
4	D2	17	SELECT INPUT-
5	D3	18	Ground
6	D4	19	Ground
7	D5	20	Ground
8	D6	21	Ground
9	D7	22	Ground
10	ACKNOWLEDGE-	23	Ground
11	BUSY	24	Ground
12	PAPER EMPTY	25	Ground
13	SELECT+	26	N/C

A.4 RS-232 Serial Port

A.4.1 Onboard RS-232 Serial Port

Connector: **JCOM2**

Type: 10-pin (2 x 5) 2.54-pitch box header

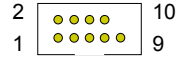

Pin	Description	Pin	Description
1	DCD	2	RXD
3	TXD	4	DTR
5	Ground	6	DSR
7	RTS	8	CTS
9	RI	10	N/C

A.4.2 On Bracket RS-232 Serial Port

Connector: **COM1**

Type: 9-pin D-sub male connector on bracket

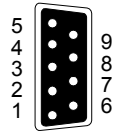

Pin	Description	Pin	Description
1	DCD	2	RXD
3	TXD	4	DTR
5	Ground	6	DSR
7	RTS	8	CTS
9	RI		

A.5 USB Port



Connector: **JUSB1, JUSB2**

Type: 10-pin (2 x 5) 2.54-pitch pin header for dual USB Ports

Pin	Description	Pin	Description
1	Vcc	6	Vcc
2	Data0- (Data2-)	7	Data1- (Data3-)
3	Data0+ (Data2+)	8	Data1+ (Data3+)
4	Ground	9	Ground
5	Ground	10	N/C

A.6 IrDA Port

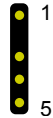

Connector: **SIR**

Type: 5-pin (1 x 5) 2.54-pitch pin header

Pin	Description
1	Vcc
2	N/C
3	IRRX
4	Ground
5	IRTX

A.7 VGA Port

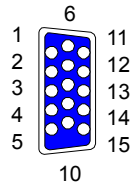

Connector: **VGA**

Type: 15-pin D-sub female connector on bracket

Pin	Description	Pin	Description	Pin	Description
1	RED	6	Ground	11	N/C
2	GREEN	7	Ground	12	VDDAT
3	BLUE	8	Ground	13	HSYNC
4	N/C	9	Vcc	14	VSYNC
5	Ground	10	Ground	15	VDCLK

A.8 LAN Port

Connector: **LAN**

Type: RJ45 connector on bracket

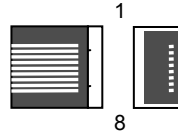

Pin	1	2	3	4	5	6	7	8
Description	TX+	TX-	RX+	N/C	N/C	RX-	N/C	N/C

A.9 AT Keyboard Port

Connector: **JAT_KB**

Type: 5-pin box header

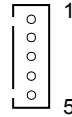

Pin	1	2	3	4	5
Description	CLK	DATA	N/C	Ground	Vcc

A.10 PS/2 Keyboard and Mouse Port

Connector: **PS2**

Type: 6-pin MiniDIN connector on bracket

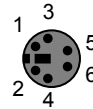

Pin	1	2	3	4	5	6
Description	KBD	MSD	Ground	N/C	KBC	MSC

Note: The PS/2 connector supports standard PS/2 keyboard directly or both PS/2 keyboard and mouse through the PS/2 Y-type cable. The cable is the standard on packing list.

Appendix B. Flash the BIOS

B.1 BIOS Auto Flash Tool

The board is based on Award BIOS and can be updated easily by the BIOS auto flash tool. You can download the tool online at the address below:

<http://www.award.com>

File name of the tool is "awdfash.exe", it's the utility that can write the data into the BIOS flash chip and update the BIOS.

B.2 Flash Method

1. Get the ".bin" file including the image of new BIOS you want to update.
2. Power on the system and flash the BIOS.
3. Re-start the system.

Notes (This page left blank intentionally)

A large, empty rectangular box with a thin black border, occupying most of the page. It is intended for the user to write notes.

Appendix C. System Resource

C.1 I/O Port Address Map

Address Range	Device	Bus	Type
0060-0060	i8042prt	0	ISA
0064-0064	i8042prt	0	ISA
0170-0170	viadsk	0	ISA
01CE-01CF	VgaSave	0	PCI
01F0-01F7	viadsk	0	ISA
02F8-02FE	Serial	0	ISA
0376-0376	viadsk	0	ISA
0378-037A	Parport	0	ISA
03B0-03BB	VgaSave	0	PCI
03C0-03CF	S3Inc	1	PCI
03C0-03DF	VgaSave	0	PCI
03D4-03DB	S3Inc	1	PCI
03F0-03F5	Floppy	0	ISA
03F6-03F6	viadsk	0	ISA
03F7-03F7	Floppy	0	ISA
03F8-03FE	Serial	0	ISA
D000-D007	viadsk	0	ISA
D008-D00F	viadsk	0	ISA
DC00-DCFF	alcxnt	0	PCI
E000-E003	alcxnt	0	PCI
E800-E8FF	alcxnt	0	PCI

C.2 Memory Address Map

Range	Device
00000000 - 0009FFFF	System board extension for PnP BIOS
000A0000 - 000AFFFF	S3 Graphics Twister
000B0000 - 000BFFFF	S3 Graphics Twister
000C0000 - 000CFFFF	S3 Graphics Twister
000CE000 - 000CFFFF	Motherboard resources
000F0000 - 000F3FFF	Motherboard resources
000F4000 - 000F7FFF	Motherboard resources
000F8000 - 000FFFFF	Motherboard resources
00100000 - 00FFFFFF	System board extension for PnP BIOS
E0000000 - E7FFFFFF	VIA CPU to AGP Controller
E0000000 - E7FFFFFF	S3 Graphics Twister
E8000000 - EBFFFFFF	VIA Standard CPU to PCI Bridge
EC000000 - EC00FFFF	S3 Graphics Twister
EC000000 - EDFFFFFFFF	VIA CPU to AGP Controller
ED000000 - ED07FFFF	S3 Graphics Twister
EF000000 - EF0000FF	Realtek RTL8139(A/B/C/8130) PCI Fast Ethernet NIC
FEE00000 - FEE0FFFF	System board extension for PnP BIOS
FFFE0000 - FFFFFFFF	System board extension for PnP BIOS

C.3 IRQ and DMA Resource

C.3.1 IRQ

IRQ Number	Device
0	System timer
1	Standard 101/102-Key or Microsoft Natural Keyboard
2	Programmable interrupt controller
3	Communications Port (COM2)
4	Communications Port (COM1)
5	Reserved
6	Standard Floppy Disk Controller
7	Printer Port (LPT1)
8	System CMOS/real time clock
9	Avance AC'97 Audio for VIA (R) Audio Controller
9	IRQ Holder for PCI Steering
10	S3 Graphics Twister
10	IRQ Holder for PCI Steering
11	VIA Tech 3038 PCI to USB Universal Host Controller
11	IRQ Holder for PCI Steering
12	PS/2 Compatible Mouse Port
13	Numeric data processor
14	Primary IDE controller (dual fifo)
14	VIA Bus Master PCI IDE Controller
15	Secondary IDE controller (dual fifo)
15	VIA Bus Master PCI IDE Controller

C.3.2 DMA

Channel	Device
0	(free)
1	(free)
2	Standard Floppy Disk Controller
3	(free)
4	Direct Memory Access Controller
5	(free)
6	(free)
7	(free)

Notes (This page left blank intentionally)

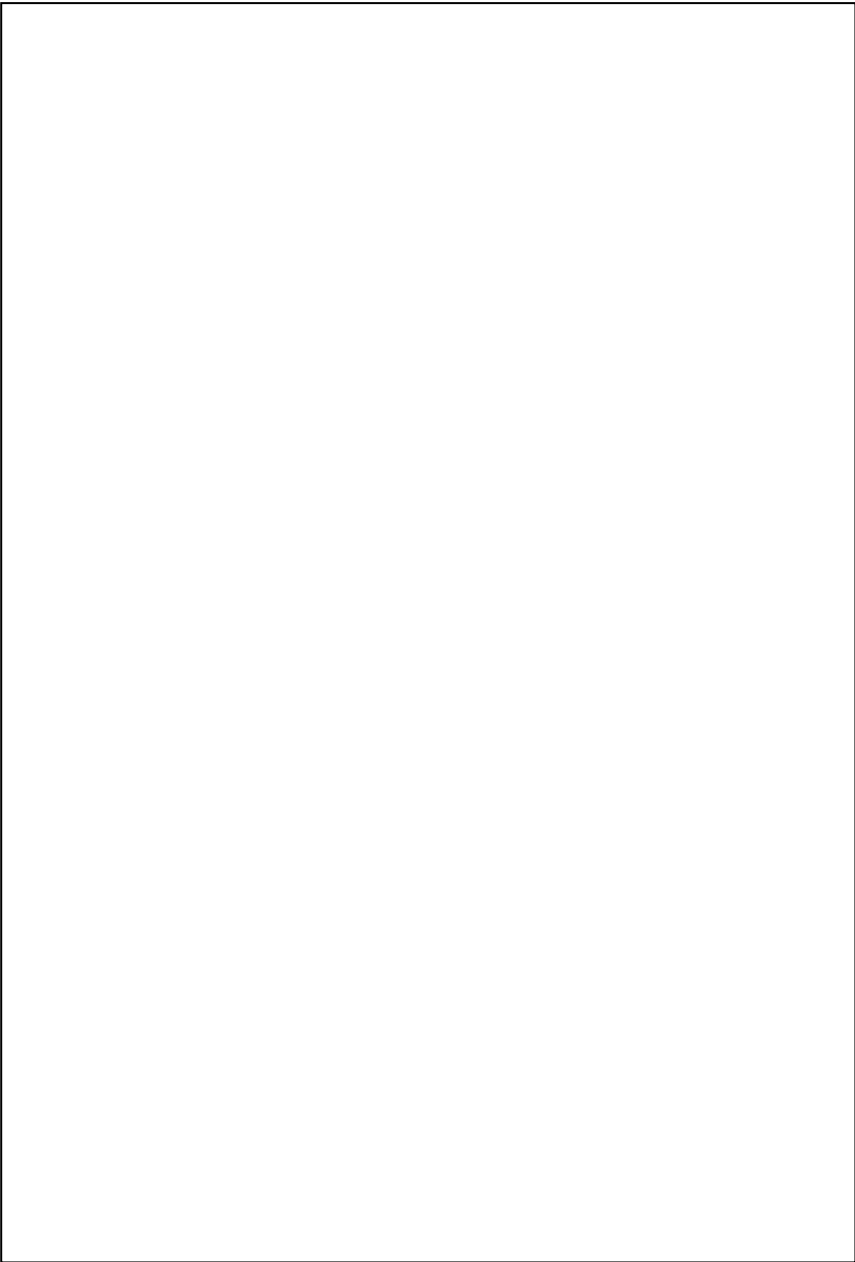

Contact Information

Any adviser or comment about our products and service, or anything we can help you please don't hesitate to contact with us. We will do our best service for you.



Global American Inc.

Address 17 Hampshire Drive Hudson
NH 03051
USA

TEL 1-603-886-3900

FAX 1-603-886-4545

Website: www.globalamericaninc.com