



User's Manual

3307600/3307610
3307670/3307672

Edition 1.4, December 11, 2006

Copyrights

This manual is copyrighted and all rights are reserved. It does not allow any non authorization in copied, photocopied, translated or reproduced to any electronic or machine readable form in whole or in part without prior written consent from the manufacturer.

In general, the manufacturer will not be liable for any direct, indirect, special, incidental or consequential damages arising from the use of inability to use the product or documentation, even if advised of the possibility of such damages. The manufacturer keeps the rights in the subject to change the contents of this manual without prior notices in order to improve the function design, performance, quality and reliability. The author assumes no responsibility for any errors or omissions, which may appear in this manual, nor does it make a commitment to update the information contained herein.

Trademarks

Intel is a registered trademark of Intel Corporation.
Award is a registered trademark of Award Software, Inc.

All other trademarks, products and or product's name mentioned herein are mentioned for identification purposes only, and may be trademarks and/or registered trademarks of their respective companies or owners.

© Copyright 2006
All Rights Reserved.
Edition 1.4, December 11, 2006

Table of Contents

Chapter 1	General Description	1
1.1	Major Features	2
1.2	Specifications	3
1.3	Board Dimensions	4
Chapter 2	Unpacking	5
2.1	Opening the Delivery Package	5
2.2	Inspection	5
Chapter 3	Hardware Installation	7
3.1	Before Installation	7
3.2	Board Layout	8
3.3	Jumper List	9
3.4	Connector List	9
3.5	Configuring the CPU	10
3.6	System Memory	11
3.7	VGA Controller	11
3.8	PCI E-IDE Drive Connector	13
3.9	Floppy Disk Drive Connector	14
3.10	Serial Port Connectors	14
3.11	Ethernet Connector	16
3.12	USB Connector	16
3.13	CMOS Data Clear	17
3.14	Power and Fan Connectors	17
3.15	Keyboard/Mouse Connectors	18
3.16	System Front Panel Control	19
3.17	Watchdog Timer	19
3.18	Audio Connectors	20
3.19	CompactFlash™ Connector	21

Chapter 4	Award BIOS Setup	23
4.1	Starting Setup	23
4.2	Using Setup	24
4.3	Main Menu	25
4.4	Standard CMOS Features	26
4.5	Advanced BIOS Features	27
4.6	Advanced Chipset Features	28
4.7	Integrated Peripherals	29
4.8	Power Management Setup	31
4.9	PnP/PCI Configurations.....	32
4.10	PC Health Status	33
4.11	Frequency/Voltage Control	33

Safety Instructions

Integrated circuits on computer boards are sensitive to static electricity. To avoid damaging chips from electrostatic discharge, observe the following precautions:

- ” Do not remove boards or integrated circuits from their anti-static packaging until you are ready to install them.
- ” Before handling a board or integrated circuit, touch an unpainted portion of the system unit chassis for a few seconds. This helps to discharge any static electricity on your body.
- ” Wear a wrist-grounding strap, available from most electronic component stores, when handling boards and components. Fasten the ALLIGATOR clip of the strap to the end of the shielded wire lead from a grounded object. Please wear and connect the strap before handle the product to ensure harmlessly discharge any static electricity through the strap.
- ” Please use an anti-static pad when putting down any components or parts or tools outside the computer. You may also use an anti-static bag instead of the pad. Please inquire from your local supplier for additional assistance in finding the necessary anti-static gadgets.

NOTE: *DO NOT TOUCH THE BOARD OR ANY OTHER SENSITIVE COMPONENTS WITHOUT ALL NECESSARY ANTI-STATIC PROTECTIONS.*

Chapter 1

General Description



3307600Series

3307670Series

The 3307600/3307670 are an Intel® 852GME GMCH/ICH4 and 3307610/3307672 are an Intel® 852GM GMCH/ICH4 chipset-based board designed. The 3307600/3307670series is ideal all-in-one embedded engine board. Additional features include an enhanced I/O with CF, DVI-I/CRT/LVDS, dual LAN, audio, COM, and USB2.0 interfaces.

Its onboard ATA/33/66/100 to IDE drive interface architecture allows the 3307600/3307670series to support data transfers of 33, 66 or 100MB/sec. to one IDE drive connection. The 3307600/3307670supports Intel® Pentium® M/Celeron® M processor 1.3~2.0GHz, and 3307610/3307672 supports ULV Intel® Celeron® M processor 600MHz/512K.

The display controller is Intel® 852GME (3307600/3307670)/852GM (3307610/3307672) with 8MB shared main memory supporting CRT display or CHRONTEL 7301 for DVI-I display, supporting up to 1600 x 1200. It also provides 18-bit single channel/36-bit dual channel LVDS interface.

System memory is also sufficient with the one DDR socket that can support up to 1GB. It also provides one IDE interface Type I/II CF card adapter.

Additional onboard connectors include two internal and one external USB2.0 ports providing faster data transmission. And dual external RJ-45 connectors for 10/100 Based Ethernet use.

1.1 Major Features

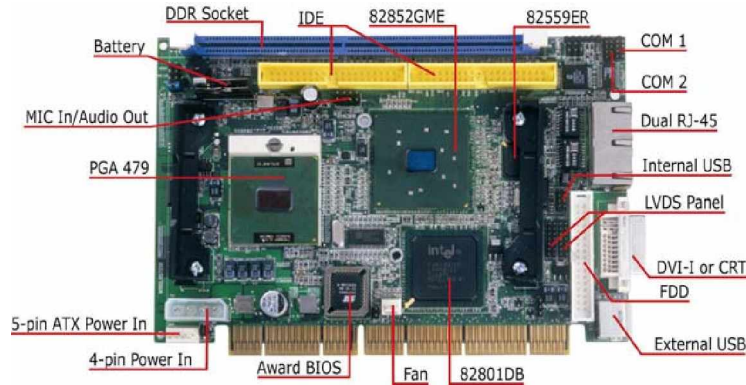

The 3307600/3307670series comes with the following features:

- ¾ Intel® Pentium® M/Celeron® M processor 1.3~2.0GHz (3307600/3307670)
ULV Intel® Celeron® M processor 600MHz/512K (3307610/3307672)
- ¾ Supports 400/533MHz FSB (only 3307600/3307670)
- ¾ One DDR socket with a max. capacity of 1GB
- ¾ Intel® 852GME GMCH/ICH4 system chipset (3307600/3307670)
Intel® 852GM GMCH/ICH4 system chipset (3307600/3307670)
- ¾ Winbond W83627HF super I/O chipset
- ¾ Intel® 82852GME graphics controller (3307600/3307670)
Intel® 82852GM graphics controller (3307610/3307672)
- ¾ 18-bit/36-bit LVDS Panel display interface
- ¾ Intel® 82562ET and 82559ER fast Ethernet controller
- ¾ AC97 3D audio controller
- ¾ Fast PCI ATA/33/66/100 IDE controller
- ¾ CF card adapter, 2 COM, 3 USB2.0
- ¾ Hardware Monitor function

1.2 Specifications

- ” **CPU:**
3307600/3307670 provides
Intel® Pentium® M processor 760 2.0GHz
Intel® Pentium® M processor 745 1.8GHz
Intel® Celeron® M processor 370 1.5GHz
Intel® Celeron® M processor 320 1.3GHz
3307610/3307672 provides ULV Intel® Celeron® M processor
600MHz/512K
- ” **Front Side Bus:**
3307600/3307670 supports 400/533MHz FSB
3307610/3307672 supports 400MHz FSB
- ” **Memory:** One DDR socket supporting up to 1GB
- ” **Chipset:**
Intel® 852GME GMCH/ICH4 (3307600/3307670)
Intel® 852GM GMCH/ICH4 (3307610/3307672)
- ” **I/O Chipset:** Winbond W83627HF
- ” **CompactFlash:** One, Type I/II IDE interface adapter
- ” **VGA:** Intel® 82852GME (3307600/3307670)/Intel® 82852GM
(3307610/3307672) for CRT display or CHRNTEL 7301 for DVI-I
display, supporting up to 1600 x 1200 (DVI-I and CRT connector is
optional)
- ” **LVDS Panel:** Supports 18-bit single channel/36-bit dual channel LVDS
interface
- ” **Ethernet:** Intel® 82562ET and 82559ER 10/100 Based LAN
- ” **Audio:** AC97 3D audio controller
- ” **IDE:** Two 2.54-pitch 40-pin IDE connectors
- ” **FDD:** Supports up to two floppy disk drives
- ” **Serial Port:** 16C550 UART-compatible RS-232/422/485 x 1 and RS-232
x 1 serial ports with 16-byte FIFO
- ” **USB:** 3 USB2.0 ports, internal x 2 and external x 1
- ” **Keyboard/Mouse:** PS/2 6-pin Mini DIN or 6-pin header
- ” **BIOS:** Award PnP Flash BIOS
- ” **Watchdog Timer:** Software programmable time-out intervals from
1~256 sec.
- ” **CMOS:** Battery backup
- ” **Hardware Monitor:** Winbond W83627HF
- ” **Board Size:** 18.6(L) x 12.2(W) x 4.2(H) cm

1.3 Board Dimensions

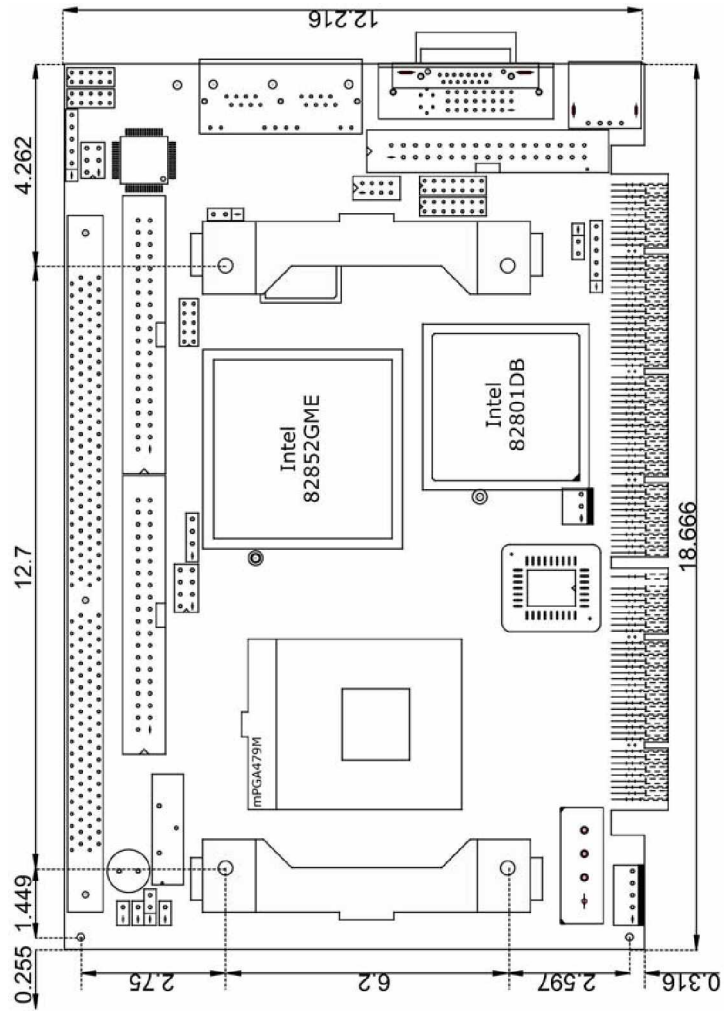

Chapter 2

Unpacking

2.1 Opening the Delivery Package

The 3307600/3307670 series is packed in an anti-static bag. The board has components that are easily damaged by static electricity. Do not remove the anti-static wrapping until proper precautions have been taken. Safety Instructions in front of this manual describe anti-static precautions and procedures.

2.2 Inspection

After unpacking the board, place it on a raised surface and carefully inspect the board for any damage that might have occurred during shipment. Ground the board and exercise extreme care to prevent damage to the board from static electricity.

Integrated circuits will sometimes come out of their sockets during shipment. Examine all integrated circuits, particularly the BIOS, processor, memory modules, ROM-Disk, and keyboard controller chip to ensure that they are firmly seated. The 3307600/3307670 series delivery package contains the following items:

- „ 3307600/3307610/3307670/3307672 Board x 1
- „ Utility CD Disk x 1
- „ Cables Package x 1
- „ Cooling Fan & Heat Sink x 1
- „ Jumper Bag x 1
- „ User's Manual



Cables Package	
NO.	Description
1	Two USB cable with bracket x 1
2	5-pin ATX power cable x 1
3	Two COM cable with bracket x 2
4	ATA/100 IDE flat cable x 2
5	Floppy flat cable x 1
6	ATX power transfer cable x 1
7	MIC/Audio cable x 1

If you want to use DVI-I device under WIN98 or WINNT, please purchase this cable separately.

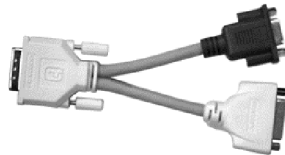

Optional Cable	
Part No.	Description
291-13010020	DVI-I to DVI+CRT cable

It is recommended that you keep all the parts of the delivery package intact and store them in a safe/dry place for any unforeseen event requiring the return shipment of the product. In case you discover any missing and/or damaged items from the list of items, please contact your dealer immediately.

Chapter 3

Hardware Installation

This chapter provides the information on how to install the hardware using the 3307600/3307670 series. This chapter also contains information related to jumper settings of switch, and watchdog timer selection etc.

3.1 Before Installation

After confirming your package contents, you are now ready to install your hardware. The following are important reminders and steps to take before you begin with your installation process.

1. Make sure that all jumper settings match their default settings and CMOS setup correctly. Refer to the sections on this chapter for the default settings of each jumper. (set JP2 1-2)
2. Go through the connections of all external devices and make sure that they are installed properly and configured correctly within the CMOS setup. Refer to the sections on this chapter for the detailed information on the connectors.
3. Keep the manual and diskette in good condition for future reference and use.

NOTE: *Since AD22 has been assigned for ISA bridge at 3307600/3307610, please make sure do not use this address for other PCI cards to avoid confliction. In order to get detailed information, please contact technical support engineer.*

3.2 Board Layout

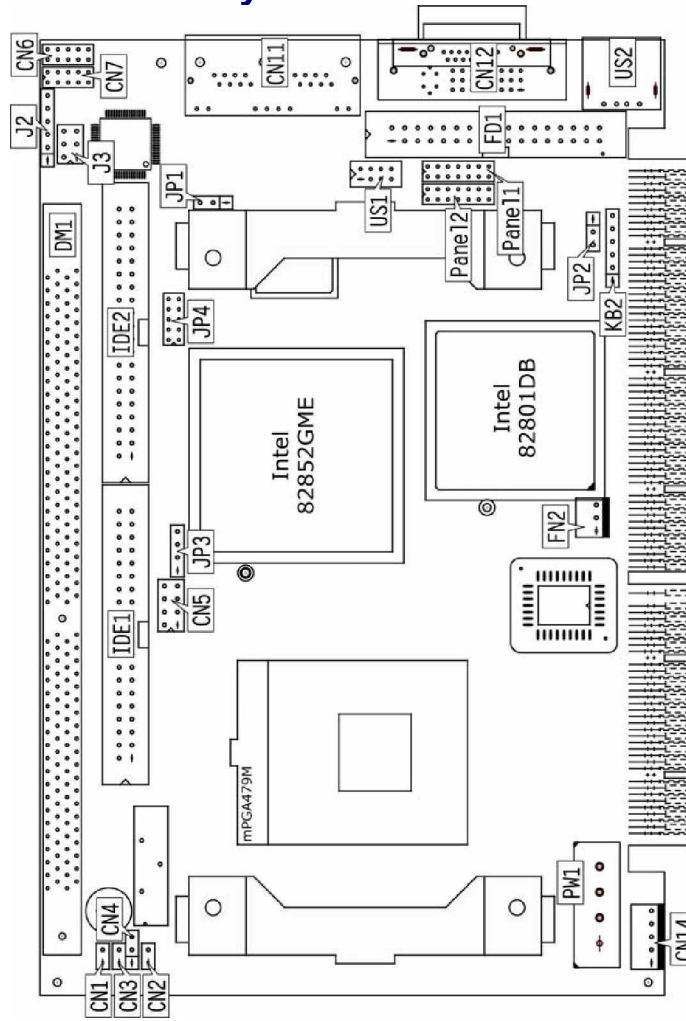

3.3 Jumper List

Jumper	Default Setting	Setting	Page
JP1	Onboard LAN 2 Enabled/Disabled Select: <i>Enabled</i>	Short 1-2	16
JP2	Clear CMOS: <i>Normal Operation</i>	Short 1-2	17
JP3	System Frequency Select: <i>400MHz</i>	Short 3-4	10
JP4	COM 2 Use RS-232 or RS-422/485 Select: <i>RS-232</i>	Open	14

3.4 Connector List

Connector	Definition	Page
CN1	Reset Switch Connector	19
CN2	2-pin ATX Power On/Off Switch	17
CN3	HDD LED Connector	19
CN4	Power LED Connector	19
CN5	MIC In/Audio Out Connector	20
CN6/CN7	COM 1-COM 2 Connector (5x2 header)	14
CN9	DVI-I Connector	11
CN11	Dual RJ-45 Connector	16
CN12	15-pin CRT Connector	11
CN13	CompactFlash Connector	21
CN14	5-pin ATX Power In Connector	17
DM1	184-pin DIMM Socket	11
FD1	Floppy Connector	14
FN2	Fan Power In Connector	17
IDE2/IDE1	Primary/Secondary IDE Connector	13
J2	Inverter Power In Connector	11
J3	RS-422/485 Connector	14
KB1	PS/2 6-pin Mini DIN KB/MS Connector	18
KB2	6-pin KB/MS Connector	18
PANEL2/PANEL1	LVDS Panel Connector	11
PW1	4-pin Power In Connector	17
US1/US2	Internal/External USB2.0 Port	16
PC1	Mini PCI Slot	----

3.5 Configuring the CPU

The 3307600/3307670 provides Intel® Pentium® M processor 760 2.0GHz, Pentium® M processor 745 1.8GHz, Celeron® M processor 370 1.5GHz, and Celeron® M processor 1.3GHz. The 3307610/3307672 embedded with ULV Intel® Celeron® M processor 600MHz/512K. 3307600/3307670 provides 533MHz, if you want to use 533MHz FSB processor, please set *JP3*, and *JP3* is only for 3307600/3307670.

z *JP3*: System Frequency Select (for 3307600/3307670only)

Options	Settings	
	JP3(1-2)	JP3(3-4)
533MHz FSB	Open	Open
400MHz FSB (default)	Open	Short



Heat Sink Installation

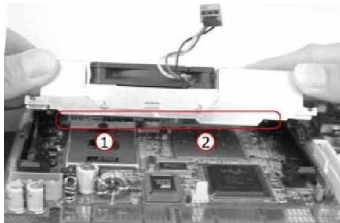

Please smear the heat sink paste over CPU and 852GM uniformly. Then secure the heat sink as the picture above.

When lock the screw, please DO NOT too tight to locking, if too tight the PCB will be curved, it may cause the board damage.

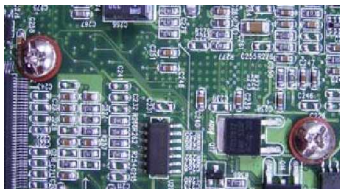

3.6 System Memory

The 3307600/3307670series provides one DDR socket at locations *DM1*. The maximum capacity of the onboard memory is 1GB.

3.7 VGA Controller

The display controller is Intel® 82852GME (3307600/3307670)/ 82852GM (3307610/3307672) for CRT display or CHRONTEL 7301 for DVI-I display, supporting up to 1600 x 1200. (DVI-I and CRT connector is optional)

3307600/3307670 series also provides 18-bit single channel/36-bit dual channel LVDS panel display interface. The 3307600/3307670series provides three methods of connecting VGA device. *CN12* offers a single standard CRT connector (DB15), or *CN9* offers DVI-I connector, or *Panel2/Panel1* offer 18-bit single channel/36-bit dual channel LVDS panel connectors.

z CN12: 15-pin CRT Connector

PIN	Description	PIN	Description
1	Red	2	Green
3	Blue	4	N/C
5	GND	6	GND
7	GND	8	GND
9	N/C	10	GND
11	N/C	12	SDA
13	HSYNC	14	VSYNC
15	SCL		

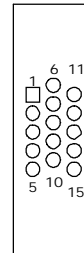

z CN9: DVI-I Connector

PIN	Description	PIN	Description
1	TDC2J	2	TDC2
3	GND	4	N/C
5	N/C	6	DDCCLK
7	DDCDATA	8	VSYNC
9	TDC1J	10	TDC1
11	GND	12	N/C
13	N/C	14	VCC5
15	GND	16	HPDET
17	TEC0-	18	TDC0
19	GND	20	N/C
21	N/C	22	GND
23	TLC	24	TLC1
25	RED	26	GREEN
27	BLUE	28	HSYNC
29	GND		

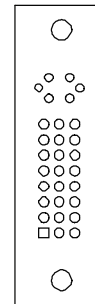

z PANEL2/PANEL1: LVDS Interface Connector

PIN	Description	PIN	Description
1	V _{LCD}	2	V _{LCD}
3	GND	4	GND
5	B0M/A0M	6	B0P/A0P
7	B1M/A1M	8	B1P/A1P
9	B2M/A2M	10	B2P/A2P
11	CLK	12	CLK
13	B3M/A3M	14	B3P/A3P

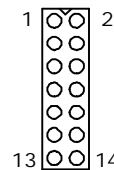

NOTE: LVDS cable should be produced very carefully. A0M & A0P have to be fabricated in twister pair (A1M & A1P, A2M & A2P and so on) otherwise the signal won't be stable.

NOTE: If use PANEL2 only, it just supports 18-bit single channel LVDS panel; If you want to use 36-bit dual channel LVDS panel, please use PANEL2 and PANEL1 combined.

z J2: Inverter Power In Connector

PIN	Description
1	+12V
2	+12V
3	+5V
4	BK_EN
5	LCD_EN
6	GND

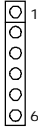

3.8 PCI E-IDE Drive Connector

IDE2 and *IDE1* are standard 2.54-pitch 40-pin connector daisy-chain driver connector serves the PCI E-IDE drive. A maximum of four ATA/33/66/100 IDE drives can be connected to the 3307600/3307670series via *IDE2* and *IDE1*.

z IDE2/IDE1: Primary/Secondary IDE Connector

PIN	Description	PIN	Description
1	Reset	2	GND
3	DATA 7	4	DATA 8
5	DATA 6	6	DATA 9
7	DATA 5	8	DATA 10
9	DATA 4	10	DATA 11
11	DATA 3	12	DATA 12
13	DATA 2	14	DATA 13
15	DATA 1	16	DATA 14
17	DATA 0	18	DATA 15
19	GND	20	N/C
21	PDREQ	22	GND
23	IOW#	24	GND
25	IOR#	26	GND
27	PIORDY	28	PD1-
29	PDACK-	30	GND
31	Interrupt	32	N/C
33	PDA1-	34	PATA66
35	PDA0-	36	PDA2-
37	PCS1-	38	PCS3-
39	HDD Active	40	GND

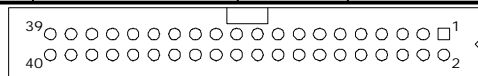

3.9 Floppy Disk Drive Connector

The 3307600/3307670 uses a standard 34-pin connector, *FD1*, for floppy disk drive connection. A total of two FDD drives may be connected to *FD1* at any given time.

z **FD1: FDD Connector**

PIN	Description	PIN	Description
1	GND	2	DRV/DEN0
3	GND	4	N/C
5	GND	6	DRV/DEN1
7	GND	8	INDEX#
9	GND	10	MTR0#
11	GND	12	DS1#
13	GND	14	DS0#
15	GND	16	MTR1#
17	GND	18	DIR#
19	GND	20	STEP#
21	GND	22	WDATA#
23	GND	24	WGATE#
25	GND	26	TRAK00#
27	GND	28	WRTPRT#
29	N/C	30	RDATA#
31	GND	32	HDSEL#
33	N/C	34	DSKCHG#

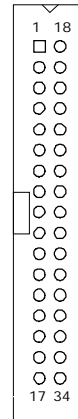

3.10 Serial Port Connectors

The 3307600/3307670 series offers NS16C550 compatible UARTs with Read/ Receive 16-byte FIFO serial ports and internal 10-pin headers and RS-422/485 connector.

z **CN6/CN7: COM 1/COM 2 Connector (5x2 Header)**

PIN	Description	PIN	Description
1	DCD	2	DSR
3	RXD	4	RTS
5	TXD	6	CTS
7	DTR	8	RI
9	GND	10	N/C



z J3: RS-422/485 Connector (3x2 Header)

PIN	Description	PIN	Description
1	TX-	2	TX+
3	RX+	4	RX-
5	GND	6	VCC



z JP4: COM 2 use RS-232 or RS-422/485 Select

Options	Settings
RS-232 (default)	Open
RS-485 by Auto (*1)	Short 1-2, 3-4, 5-7, 8-10
RS-485 by -RTS (*-1)	Short 1-2, 3-4, 7-9, 8-10
RS-422/485 Full Duplex (*2)	Short 1-2, 3-4, 6-8



NOTE: *1: 2-wires RS-485 function

*2: 4-wires point-to-point full duplex function

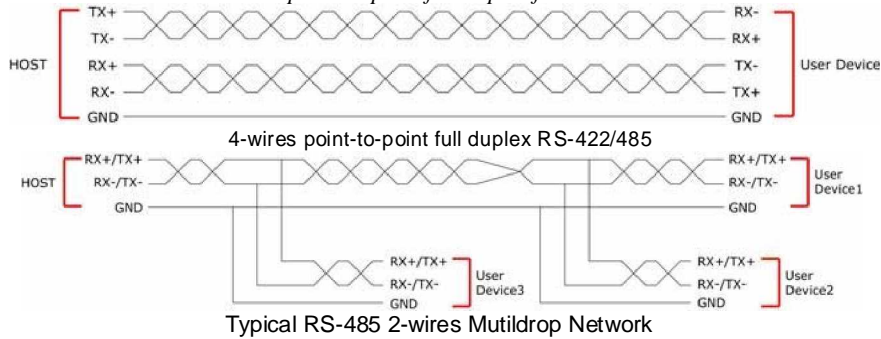

3.11 Ethernet Connector

The 3307600/3307670series provides two external RJ-45 interface connectors. Please refer to the following for its pin information.

z CN11: Dual RJ-45 Connector

PIN	Description
1	TX+
2	TX-
3	RX+
4	R/C GND
5	R/C GND
6	RX-
7	R/C GND
8	R/C GND

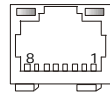

z JP1: Onboard LAN 2 Enabled/Disabled Select

Options	Settings
Enabled (default)	Short 1-2
Disabled	Short 2-3



3.12 USB Connector

The 3307600/3307670series provides one 8-pin internal connector at location *US1*, and one external USB2.0 ports at *US2*, for three USB2.0 ports to the 3307600/3307670series.

z US2: External USB2.0 Port

PIN	Description
1	VCC
2	BD0-
3	BD0+
4	GND

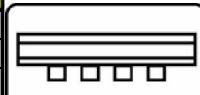

z US1: Internal USB2.0 Port

PIN	Description	PIN	Description
1	VCC	2	VCC
3	BD0-	4	BD1-
5	BD0+	6	BD1+
7	GND	8	GND



3.13 CMOS Data Clear

The 3307600/3307670series has a Clear CMOS jumper on *JP2*.

z JP2: Clear CMOS

Options	Settings
Normal Operation (default)	Short 1-2
Clear CMOS	Short 2-3



IMPORTANT: Before you turn on the power of your system, please set *JP2* to Short 1-2 for normal operation.

3.14 Power and Fan Connectors

3307600/3307670series provides one 4-pin power in at *PW1*.

z PW1: 4-pin Power In Connector

PIN	Description
1	VCC
2	GND
3	GND
4	+12V

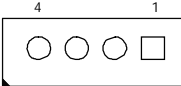

z CN14: 5-pin ATX Power In Connector

PIN	Description
1	GND
2	PS_ON
3	VCC
4	5VSB
5	VCC



z CN2: 2-pin ATX Power On/Off Switch

PIN	Description
1	Pull 220Ω to VCCSTBY
2	PANSWIN



Z FN2: Fan Power In Connector

PIN	Description
1	GND
2	+12V
3	Fan In 2



Connector *FN2* onboard 3307600/3307670series is a 3-pin fan power output connector.

3.15 Keyboard/Mouse Connectors

The 3307600/3307670series offers two methods for keyboard/mouse connections. The connections are done via *KB1* for an external PS/2 type keyboard/mouse connection, and *KB2* for 6-pin keyboard/mouse header.

Z KB1: PS/2 6-pin Mini DIN Keyboard/Mouse Connector

PIN	Description
1	Keyboard Data
2	Mouse Data
3	GND
4	+5V
5	Keyboard Clock
6	Mouse Clock

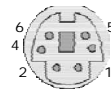

Z KB2: 6-pin Keyboard/Mouse Connector

PIN	Description
1	Keyboard Clock
2	Keyboard Data
3	Mouse Data
4	GND
5	+5V
6	Mouse Clock

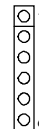

3.16 System Front Panel Control

The 3307600/3307670 series has one LED at location *CN3* that indicates the system front panel status. This visual feature of the HDD LED may also be connected to and external HDD LED via connector *CN8*. At location *CN1* is reset button.

z *CN1: Reset Button Connector*

PIN	Description
1	GND
2	Reset



z *CN3: HDD LED Connector*

PIN	Description
1	Pull 150Ω to +5V
2	HDD LED



z *CN4: Power LED Connector*

PIN	Description
1	Pull 330Ω to +5V
2	GND



3.17 Watchdog Timer

Once the Enable cycle is active a Refresh cycle is requested before the time-out period. This restarts counting of the WDT period. When the time counting goes over the period preset of WDT, it will assume that the program operation is abnormal. A system reset signal will restart when such error happens.

The following sample programs show how to enable, disable and refresh the watchdog timer:

```

-----
;Enter the WDT function mode, interruptible double-write
-----
MOV     DX, 2EH
MOV     AL, 87H
OUT     DX, AL
OUT     DX, AL
MOV     DX, 2EH
MOV     AL, 07H
OUT     DX, AL
MOV     DX, 2FH

```



```

MOV     AL, 08H
OUT     DX, AL
MOV     DX, 2EH
MOV     AL, F5H
OUT     DX, AL           ;select CRFO
MOV     DX, 2FH
MOV     AL, 80H
OUT     DX, AL
MOV     DX, 2EH
MOV     AL, F7H
OUT     DX, AL
MOV     DX, 2FH

MOV     AL, 00H
OUT     DX, AL
MOV     DX, 2EH
MOV     AL, F6H
OUT     DX, AL
MOV     DX, 2FH
MOV     AL, 00H           ; *00H=Disabled
OUT     DX, AL

-----
;Exit extended function mode
-----

MOV     DX, 2EH
MOV     AL, AAH
OUT     DX, AL

```

User can also use AL, 00H's defined time for reset purposes, e.g.00H for Disable, 01H = 1sec, 02H=2sec....FFH=255sec.

3.18 Audio Connectors

The 3307600/3307670 series has an onboard AC97 3D audio controller. The following tables list the pin assignments of the Line In/Line Out connector.

z CN5: MIC In/Line Out Connector

PIN	Description	PIN	Description
1	AOUTL	2	AOUTR
3	GND	4	GND
5	MIC IN	6	N/C
7	GND	8	GND



3.19 CompactFlash™ Connector

The 3307600/3307670series also offers a Type I/II CompactFlash™ connector which is IDE interface located at the solder side of the board. The designated CN13 connector, once soldered with an adapter, can hold CompactFlash™ cards of various sizes. Please turn off the power before inserting the CF card.

Z CN13: CompactFlash™ Connector

PIN	Description	PIN	Description
1	GND	2	IDE_PDD3
3	IDE_PDD4	4	IDE_PDD5
5	IDE_PDD6	6	IDE_PDD7
7	IDE_PDCS1#	8	GND
9	GND	10	GND
11	GND	12	GND
13	+3.3V	14	GND
15	GND	16	GND
17	GND	18	IDE_PDA2
19	IDE_PDA1	20	IDE_PDA0
21	IDE_PDD0	22	IDE_PDD1
23	IDE_PDD2	24	GND
25	GND	26	GND
27	IDE_PDD11	28	IDE_PDD12
29	IDE_PDD13	30	IDE_PDD14
31	IDE_PDD15	32	IDE_PDCS3#
33	GND	34	IDE_PDIOR#
35	IDE_PDIOW#	36	+3.3V
37	INT_IRQ15	38	+3.3V
39	+3.3V	40	N/C
41	RESET#	42	IDE_PDIORDY
43	CF_PDERQ	44	CF_REGB
45	IDE_ACTP#	46	DETECT
47	IDE_PDD8	48	IDE_PDD9
49	IDE_PDD10	50	GND

Inserting a CompactFlash™ card into the adapter is not a difficult task. The socket and card are both keyed and there is only one direction for the card to be completely inserted. Refer to the diagram on the following page for the traditional way of inserting the card.

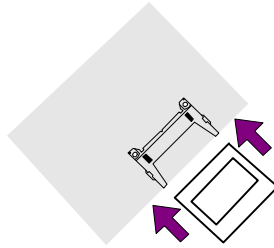

Chapter 4

Award BIOS Setup

The 3307600/3307670 series uses Award BIOS for the system configuration. The Award BIOS setup program is designed to provide the maximum flexibility in configuring the system by offering various options that could be selected for end-user requirements. This chapter is written to assist you in the proper usage of these features.

4.1 Starting Setup

The Award BIOS is immediately activated when you first power on the computer. The BIOS reads the system information contained in the CMOS and begins the process of checking out the system and configuring it. When it finishes, the BIOS will seek an operating system on one of the disks and then launch and turn control over to the operating system.

While the BIOS is in control, the Setup program can be activated in one of two ways:

1. By pressing immediately after switching the system on, or
2. By pressing the key when the following message appears briefly at the bottom of the screen during the POST (Power On Self Test).

Press DEL to enter SETUP.

If the message disappears before you respond and you still wish to enter Setup, restart the system to try again by turning it OFF then ON or pressing the "RESET" button on the system case. You may also restart by simultaneously pressing <Ctrl>, <Alt>, and <Delete> keys. If you do not press the keys at the correct time and the system does not boot, an error message will be displayed and you will be asked to...

PRESS F1 TO CONTINUE, DEL TO ENTER SETUP

4.2 Using Setup

In general, you use the arrow keys to highlight items, press <Enter> to select, use the <PageUp> and <PageDown> keys to change entries, and press <Esc> to quit. The following table provides more detail about how to navigate in the Setup program using the keyboard.

↑	Move to previous item
↓	Move to next item
←	Move to previous item
→	Move to previous item
Esc key	Main Menu -- Quit and not save changes into CMOS Status Page Setup Menu and Option Page Setup Menu -- Exit current page and return to Main Menu
PgUp key	Decrease the numeric value or make changes
PgDn key	Increase the numeric value or make changes
+ key	Increase the numeric value or make changes
- key	Decrease the numeric value or make changes
F1 key	Reserved
F2 key	Change color from total 8 colors. F2 to select color forward
F3 key	F2 to select color backward
F4 key	Reserved
F5 key	Reserved
F6 key	Reserved
F7 key	Reserved
F8 key	Reserved
F9 key	Reserved
F10 key	Save all the CMOS changes, only for Main Menu

4.3 Main Menu

Once you enter the Award BIOS CMOS Setup Utility, the Main Menu will appear on the screen. The Main Menu allows you to select from several setup functions and two exit choices. Use the arrow keys to select among the items and press <Enter> to enter the sub-menu.

X Standard CMOS Features	X Frequency/Voltage Control
X Advanced BIOS Features	Load Fail-Safe Defaults
X Advanced Chipset Features	Load Optimized Defaults
X Integrated Peripherals	Set Supervisor Password
X Power Management Setup	Set User Password
X PnP/PCI Configurations	Save & Exit Setup
X PC Health Status	Exit Without Saving
Esc: Quit F9: Menu in BIOS ↑↓←→: Select Item	
F10: Save & Exit Setup	

NOTE: *A brief description of the highlighted choice appears at the bottom of the screen.*

4.4 Standard CMOS Features

The standard CMOS is used for the basic hardware system configuration. The main function is for Data/Time and Floppy/Hard Disk Drive settings. Please refer to the following screen for the setup. When the IDE hard disk drive you are using is larger than 528MB, you must set the HDD mode to LBA mode. Please use the IDE setup utility in BIOS setup to install the HDD correctly.

Phoenix - AwardBIOS CMOS Setup Utility
Standard CMOS Features

Date (mm:dd:yy)	Mon, Aug 9 2004	Item Help
Time (hh:mm:ss)	10 : 32 : 57	
X IDE Primary Master	[Auto]	
X IDE Primary Slave	[Auto]	
X IDE Secondary Master	[Auto]	
X IDE Secondary Slave	[Auto]	
Drive A	[1.44M, 3.5in.]	
Video	[EGA/VGA]	
Halt On	[All, But Keyboard]	
Base Memory	640K	
Extended Memory	252928K	
Total Memory	253952K	
↑↓←→: Select Item +/-/PU/PD: Value F10: Save Esc: Quit F1: General Help		
F5: Previous Values F6: Fail-Safe Defaults F7: Optimized Defaults		

4.5 Advanced BIOS Features

This section allows you to configure your system for the basic operation. You have the opportunity to select the system's default speed, boot-up sequence, keyboard operation, shadowing and security.

Phoenix - AwardBIOS CMOS Setup Utility
Advanced CMOS Features

X CPU Feature	[Press Enter]	Item Help
X Hard Disk Boot Priority	[Press Enter]	
Virus Warning	[Disabled]	
CPU L1 & L2 Cache	[Enabled]	
CPU L3 Cache	[Enabled]	
Quick Power On Self Test	[Enabled]	
First Boot Device	[Floppy]	
Second Boot Device	[Hard Disk]	
Third Boot Device	[CDROM]	
Boot Other Device	[Enabled]	
Boot Up Floppy Seed	[Enabled]	
Boot Up NumLock Status	[On]	
Gate A20 Option	[Fast]	
Typematic Rate Setting	[Disabled]	
X Typematic Rate (Chars/Sec)	6	
X Typematic Delay (Msec)	250	
Security Option	[Setup]	
APIC Mode	[Enabled]	
MPS Version Control For OS	[1.4]	
OS Select For DRAM > 64MB	[Non-OS2]	
Report No FDD For WIN 95	[No]	
Small Logo(EPA) Show	[Enabled]	
↑ ↓ ← →: Select Item +/-/PU/PD: Value F10: Save Esc: Quit F1: General Help		
F5: Previous Values F6: Fail-Safe Defaults F7: Optimized Defaults		

4.6 Advanced Chipset Features

This section allows you to configure the system based on the specific features of the installed chipset. This chipset manages bus speeds and the access to the system memory resources, such as DRAM and the external cache. It also coordinates the communications between the conventional ISA and PCI buses. It must be stated that these items should never be altered. The default settings have been chosen because they provide the best operating conditions for your system. You must consider making any changes only if you discover that the data has been lost while using your system.

Phoenix - AwardBIOS CMOS Setup Utility Advanced Chipset Features

DRAM Timing Selectable	[By PSD]	Item Help
CAS Latency Time	[2.5]	
Active to Precharge Delay	[7]	
DRAM RAS# to CAS# Delay	[3]	
DRAM RAS# to Precharge	[3]	
DRAM Data Integrity Mode	[Non-ECC]	
MGM Core Frequency	[Auto Max 266MHz]	
System BIOS Cacheable	[Enabled]	
Video BIOS Cacheable	[Enabled]	
Memory Hole At 15M-16M	[Disabled]	
Delayed Transaction	[Enabled]	
Delay Prior to Thermal	[16 Min]	
AGP Aperture Size (MB)	[64]	
** ON-chip VGA Setting **		
On-chip VGA	[Enabled]	
On-chip Frame Buffer size	[32MB]	
Boot Display	[CRT+EFPP]	
Panel Number	[1]	
↑ ↓ ← →: Select Item +/-/PU/PD: Value F10: Save Esc: Quit F1: General Help		
F5: Previous Values F6: Fail-Safe Defaults F7: Optimized Defaults		

4.7 Integrated Peripherals

The IDE hard drive controllers can support up to two separate hard drives. These drives have a master/slave relationship that is determined by the cabling configuration used to attach them to the controller. Your system supports two IDE controllers – a primary and a secondary – so you can install up to four separate hard disks.

PIO means Programmed Input/Output. Rather than having the BIOS issue a series of commands to affect the transfer to or from the disk drive, PIO allows the BIOS to tell the controller what it wants and then let the controller and the CPU perform the complete task by themselves. This is much simpler and more efficient (also faster).

Phoenix - AwardBIOS CMOS Setup Utility Integrated Peripherals

X OnChip IDE Device	[Press Enter]	Item Help
X Onboard Device	[Press Enter]	
X SuperIO Device	[Press Enter]	
Onboard LAN Control	[Enabled]	
↑↓←→: Select Item +/-/PU/PD: Value F10: Save Esc: Quit F1: General Help		
F5: Previous Values F6: Fail-Safe Defaults F7: Optimized Defaults		

Phoenix - AwardBIOS CMOS Setup Utility OnChip IDE Device

On-Chip Primary PCI IDE	[Enabled]	Item Help
IDE Primary Master PIO	[Auto]	
IDE Primary Slave PIO	[Auto]	
IDE Primary Master UDMA	[Auto]	
IDE Primary Slave UDMA	[Auto]	
On-Chip Secondary PCI IDE	[Enabled]	
IDE Secondary Master PIO	[Auto]	
IDE Secondary Slave PIO	[Auto]	
IDE Secondary Master UDMA	[Auto]	
IDE Secondary Slave UDMA	[Auto]	
IDE HDD Block Mode	[Enabled]	
↑↓←→: Select Item +/-/PU/PD: Value F10: Save Esc: Quit F1: General Help		
F5: Previous Values F6: Fail-Safe Defaults F7: Optimized Defaults		

Phoenix - AwardBIOS CMOS Setup Utility
Onboard Device

USB Controller	[Enabled]	Item Help
USB 2.0 Controller	[Enabled]	
USB Keyboard Support	[Enabled]	
USB Mouse Support	[Enabled]	
AC97 Audio	[Auto]	
Init Display First	[PCI Slot]	
↑↓←→: Select Item +/-/PU/PD: Value F10: Save Esc: Quit F1: General Help		
F5: Previous Values F6: Fail-Safe Defaults F7: Optimized Defaults		

Phoenix - AwardBIOS CMOS Setup Utility
SuperIO Device

Onboard FDC Controller	[Enabled]	Item Help
Onboard Serial Port 1	[3F8/IRQ4]	
Onboard Serial Port 2	[2F8/IRQ3]	
UART Mode Select	[Normal]	
RxD, TxD Active	[Hi, Lo]	
IR Transmission Delay	[Enabled]	
UR2 Duplex Mode	[Half]	
Use IR Pins	[IR-Rx2Rx2]	
↑↓←→: Select Item +/-/PU/PD: Value F10: Save Esc: Quit F1: General Help		
F5: Previous Values F6: Fail-Safe Defaults F7: Optimized Defaults		

4.8 Power Management Setup

The power management setup allows user to configure the system for saving energy in a most effective way while operating in a manner consistent with his owns style of computer use.

Phoenix - AwardBIOS CMOS Setup Utility
Power Management Setup

Power-Supply Type	[ATX]	Item Help
ACPI Function	[Enabled]	
ACPI Suspend Type	[S1(POS)]	
X Run VGABIOS If S3 Resume	Auto	
Power Management	[Min Saving]	
Video Off Method	[DPMS]	
Video Off In Suspend	[Yes]	
Suspend Type	[Stop Grant]	
MODEM Use IRQ	[3]	
Suspend Mode	1 Hour	
HDD Power Down	15 Min	
Soft-Off by PWR-BTTN	[Instant-Off]	
PWRON After PWR-Fail	[Former-STS]	
CPU THRM-Throttling	[50.0%]	
Wake-Up by PCI Card	[Disabled]	
Power On by Ring	[Disabled]	
Wake Up On LAN	[Disabled]	
X USB KB Wake-Up From S3	Disabled	
Resume by Alarm	[Disabled]	
X Date(of Month) Alarm	0	
X Time(hh:mm:ss) Alarm	0 : 0 : 0	
** Reload Global Timer Events **		
Primary IDE 0	[Disabled]	
Primary IDE 1	[Disabled]	
Secondary IDE 0	[Disabled]	
Secondary IDE 1	[Disabled]	
FDD, COM, LTP Port	[Disabled]	
PCI PIRQ[A-D]#	[Disabled]	
↑↓←→: Select Item +/-/PU/PD: Value F10: Save Esc: Quit F1: General Help		
F5: Previous Values F6: Fail-Safe Defaults F7: Optimized Defaults		

4.9 PnP/PCI Configurations

This section describes the configuration of the PCI bus system. Peripheral Components Interconnect (PCI), is a system that allows I/O devices to operate at speeds nearing the speed the CPU itself uses when communicating with its own special components. This section covers some very technical items and it is strongly recommended that only experienced users should make any changes to the default settings.

Phoenix - AwardBIOS CMOS Setup Utility PnP/PCI Configurations

Reset Configuration Data	[Disabled]	Item Help
Resources Controlled By	[Auto(ESCD)]	
X IRQ Resources	Press Enter	
PCI/VGA Palette Snoop	[Disabled]	
↑ ↓ ← →: Select Item +/-/PU/PD: Value F10: Save Esc: Quit F1: General Help		
F5: Previous Values F6: Fail-Safe Defaults F7: Optimized Defaults		

4.10 PC Health Status

Phoenix - AwardBIOS CMOS Setup Utility
PC Health Status

CPU Warning Temperature	[Disabled]	Item Help
Current CPU Temperature		
Current SYSTEM Temperature		
Current CPUFAN Speed		
VCORE		
+3.3V		
+5V		
+12V		
VBAT(V)		
Shutdown Temperature	[Disabled]	
↑↓←→: Select Item +/-/PU/PD: Value F10: Save Esc: Quit F1: General Help		
F5: Previous Values F6: Fail-Safe Defaults F7: Optimized Defaults		

4.11 Frequency/Voltage Control

Phoenix - AwardBIOS CMOS Setup Utility
Frequency/Voltage Control

Auto Detect PCI Clk	[Enabled]	Item Help
Spread Spectrum	[Disabled]	
↑↓←→: Select Item +/-/PU/PD: Value F10: Save Esc: Quit F1: General Help		
F5: Previous Values F6: Fail-Safe Defaults F7: Optimized Defaults		

Any advice or comments about our products and service, or anything we can help you with please don't hesitate to contact with us. We will do our best to support you for your products, projects and business.

Global American Inc.

Address: 17 Hampshire Drive
Hudson, NH 03051

TEL: Toll Free (U.S. Only) 800-833-8999
(603)886-3900

FAX: (603)886-4545

Website: <http://www.globalamericaninc.com>

E-Mail: salesinfo@globalamericaninc.com

