



integration with integrity

User's Manual

5.25" SBC 3308120

Version 1.0, March 2008

---

---

## **Copyrights**

This manual is copyrighted and all rights are reserved. It does not allow any non authorization in copied, photocopied, translated or reproduced to any electronic or machine readable form in whole or in part without prior written consent from the manufacturer.

In general, the manufacturer will not be liable for any direct, indirect, special, incidental or consequential damages arising from the use of inability to use the product or documentation, even if advised of the possibility of such damages. The manufacturer keeps the rights in the subject to change the contents of this manual without prior notices in order to improve the function design, performance, quality and reliability. The author assumes no responsibility for any errors or omissions, which may appear in this manual, nor does it make a commitment to update the information contained herein.

## **Trademarks**

Intel is a registered trademark of Intel Corporation.

Award is a registered trademark of Award Software, Inc.

All other trademarks, products and or product's name mentioned herein are mentioned for identification purposes only, and may be trademarks and/or registered trademarks of their respective companies or owners.

---

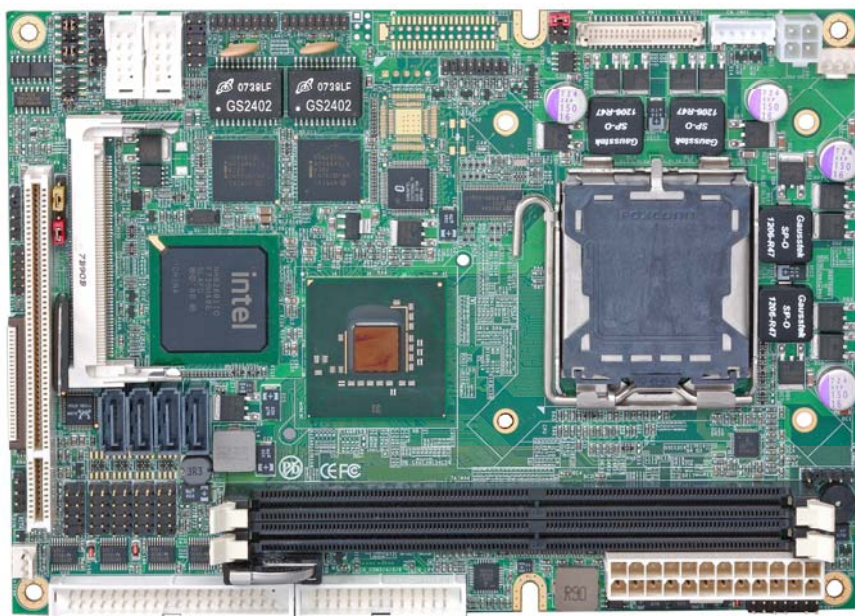

# Packing List

---

Please check package component before you use our products.

## Hardware:

3308120 Embedded Miniboard

## Cable Kit:



SATA Cable x 2



26-pin Slim Type Floppy Cable x 1



DVI module x 1  
(3308120A Only)



USB Cable x 2



Printer Port Cable x 1



COM Port Cable x 2



Quad COM ports DB9 male Cable



LAN Connector x1 & LAN Cable x 2



Audio Port Cable x 1



PS/2 keyboard & mouse cable x 1



VGA cable x 1

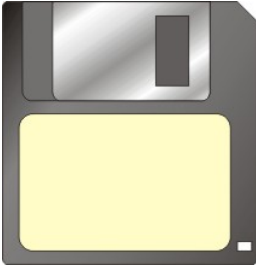

RAID drivers Disc for Windows 2000,  
Windows XP and Windows Server 2003

**Other Accessories:**

Divers CD (including User's Manual) x 1

# Index

Chapter1 <Introduction> .....	7
1.1 <Product Overview> .....	7
1.2 <Product Specification> .....	8
1.3 <Block Diagram> .....	10
1.4 <Mechanical Drawing > .....	11
1.5 <Motherboard Dimension > .....	11
1.5 <Motherboard Dimension > .....	12
Chapter 2 <Hardware Setup> .....	13
2.1 <Connector Location> .....	13
2.2 <Jumper Reference> .....	14
2.3 <Connector Reference> .....	15
2.3.1 <Internal Connectors> .....	16
2.4 <CPU and Memory Setup> .....	17
2.4.1 <CPU installation> .....	17
2.4.2 <Memory installation> .....	18
2.5 <CMOS Setup> .....	19
2.6 <Serial ATA installation> .....	20
2.7 <Floppy Installation> .....	21
2.8 <LAN installation> .....	22
2.9 <Onboard Display Interface> .....	23
2.9.1 <Analog Display> .....	23
2.9.2 <LVDS Display 3308120C Only > .....	24
2.9.3 <DVI Display 3308120A & B Only > .....	28
2.10 <Audio Installation> .....	29
2.11 <GPIO interface> .....	31
2.12 <USB Installation> .....	32
2.13 <Power and Fan Installation> .....	34

2.14 <Serial Port> .....	36
2.15 <Switch and Indicator> .....	37
<b>Chapter 3 &lt;System Configuration&gt; .....</b>	<b>39</b>
3.1 <SATA configuration>.....	39
3.2 <SATA RAID Configuration> .....	40
3.3 <Audio Configuration> .....	45
3.4 <Video Memory Setup> .....	46
3.5 <Display Properties Setting>.....	48
<b>Chapter 4 &lt;BIOS Setup&gt; .....</b>	<b>50</b>
<b>Appendix A &lt;I/O Port Pin Assignment&gt; .....</b>	<b>52</b>
A.1 <Serial ATA Port>.....	52
A.2<Floppy Port> .....	52
A.3 <IrDA Port>.....	53
A.5 <VGA Port> .....	54
A.6 <LAN Port>.....	54
<b>Appendix B &lt;System Resources&gt; .....</b>	<b>57</b>
<b>Appendix C &lt;Programming GPIO's&gt; .....</b>	<b>64</b>
<b>Appendix D &lt;Watch Dog timer Setting &gt;.....</b>	<b>65</b>
<b>Contact Information.....</b>	<b>66</b>

**(This Page is Left for Blank)**



## **Chapter1 <Introduction>**

### **1.1 <Product Overview>**

3308120 is the motherboard with last Intel desktop technology with 5.25 Embedded form factor. Based on Intel® Q35 and ICH9DO, the board integrates a new Core 2 Quad/ Core2 Duo/ Celeron processor 775-pin socket, DDR2 memory socket, Intel® Graphic Media Accelerator 3000 technology, Serial ATA II with RAID function for a powerful desktop system.

#### **Intel® LGA775 processor**

The Intel® Core 2 Quad/ Core 2 Duo/Celeron processor now comes with a new form factor with 775-pin LGA package, for 800/1066/1333MHz front-side-bus, 4MB L2 cache, and for 65nm manufacturing technology, the LGA processor without pin header on solder side can make user installing the processor on the socket easier.

#### **Intel® Q35 and ICH9DO chipset**

The Intel Q35 integrates DDR2 667/800MHz for memory, and Graphic Media Accelerator (GMA) 3000 technology for new graphic engine. It can provide up to 384MB of frame buffer when you install over 1GB of system memory. The ICH9DO integrates with up to 6 USB2.0 interfaces , and serial ATA II interface with RAID function.

#### **Flexible Extension Interface**

The board provides one PCI-slot for graphics card, it also can support PCI-slot for LAN card or other devices. The board also provides mini-PCI socket.

## 1.2 <Product Specification>

### General Specification

Form Factor	5.25 inch Embedded Miniboard
CPU	Intel® Core 2 Quad/ Core 2 Duo/ Celeron processor with <b>LGA775</b> socket Package type: LGA 775 Front side bus: 800/1066/1333MHz (133/200/266MHz x 4)
Memory	2 x 240-pin DDR2 667/800 MHz DIMM up to 4GB
Chipset	Intel® Q35 (Northbridge) and ICH9DO (Southbridge)
BIOS	Phoenix-Award v6.00PG 8Mb SPI flash BIOS
Green Function	Power saving mode includes doze, standby and suspend modes. ACPI version 1.0 and APM version 1.2 compliant
Watchdog Timer	System reset programmable watchdog timer with 1 ~ 255 sec./min. of timeout value
Real Time Clock	Intel® ICH9DO built-in RTC with lithium battery
Serial ATAII	Intel® ICH9DO integrates 4 Serial ATA II interface up to 300MB/s RAID 0, 1,5,10 Intel Matrix Storage Technology supported

### Multi-I/O Port

Chipset	Intel® 82801IO (ICH9DO) with Winbond® W83627DHG controller
Serial Port	Five internal RS-232 and one internal RS232/422/485 serial ports
USB Port	Eight Hi-Speed USB 2.0 ports with 480Mbps of transfer rate
Floppy Port	One slim type Floppy port
IrDA Port	One IrDA compliant Infrared interface support SIR
K/B & Mouse	Internal PS/2 keyboard and mouse ports
GPIO	One 12-pin Digital I/O connector with 8-bit programmable I/O interface
Smart Fan	One CPU fan connectors for fan speed controllable

### VGA Display Interface

Chipset	Intel® Q35 GMA3100 (Graphic Memory Controller Hub)
Frame Buffer	Up to 384MB shared with system memory
Display Type	CRT, LCD monitor with analog display Onboard 18/24-bit dual channel LVDS interface (3308120C Only) Onboard DVI interface (3308120A & B Only)
Connector	Internal DB15 female connector Onboard 40-pin LVDS connector (3308120C Only) Onboard 26-pin DVI Connector (3308120A & B Only)

## 3308120 User's Manual

### Ethernet Interface

Controller	Two Intel 82573L Gigabit Ethernet controller
Type	Triple speed 10/100/1000Base-T Auto-switching Fast Ethernet Full duplex, IEEE802.3U compliant
Connector	Two internal RJ45 connectors

### Audio Interface

Chipset	Intel® ICH9DO with Realtek ALC888HD Audio Intel High Definition Audio compliance
Interface	2 channels sound output
Connector	Internal 10-pin header for line-out, MIC-in, 4-pin header for CD-IN

### Expansive Interface

Mini PCI	One Mini-PCI socket <b>TYPE III A</b> (32-bit, 33MHz) Power supply: +3.3V, +5V
----------	---

### Power and Environment

Power Requirement	Standard ATX <b>24-pin (20-pin is compatible)</b> power supply Additional +12V 4-pin power connector
Dimension	203 (L) x 146 (H) mm
Temperature	Operating within 0 ~ 60°C (32 ~ 140°F) Storage within -20 ~ 85°C (-4 ~ 185°F)

### Ordering Code

<b>3308120A</b>	Onboard VGA, 2 x Intel Gigabit LAN, 8 x USB2.0, Mini-PCI, PCI, 6 x Serial Port, 1 x slim FDD, Realtek ALC888 HD 2.1 Channel Audio, 4 x SATA, 1x IrDA, 1 x LPT and 1 x DVI
<b>3308120B</b>	Same as the 3308120A but with two DVI interface
<b>3308120C</b>	Onboard VGA, 2 x Intel Gigabit LAN, 8 x USB2.0, Mini-PCI, PCI, 6 x Serial Port, 1 x slim FDD, Realtek ALC888 HD 2.1 Channel Audio, 4 x SATA, 1 x IrDA, 1 x LPT and 1 x LVDS
<b>1801120</b>	Mini PCI with one 44-pin Ultra DMA 33 IDE interface support up to 2 ATAPI devices 1 x Compact Flash Type II and 2 x serial ATA interface

The specifications may be different as the actual production.

For further product information please visit the website at <http://www.globalamericaninc.com>

### 1.3 <Block Diagram>

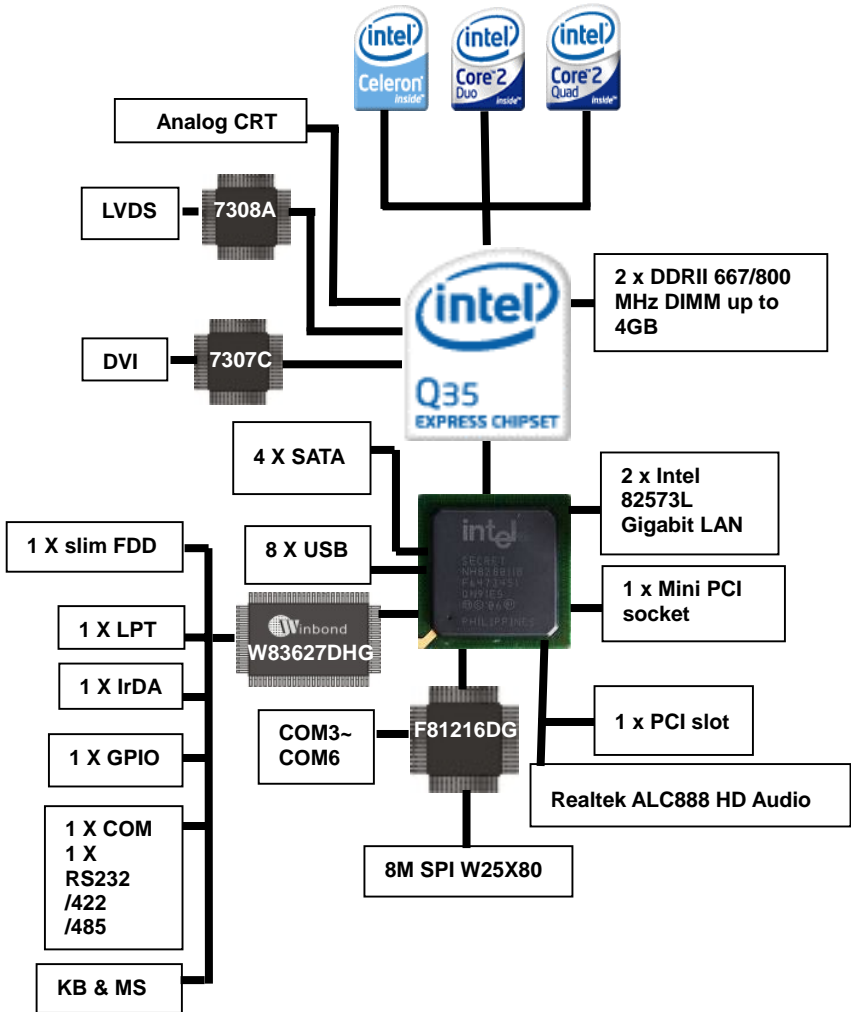

## 1.4 <Mechanical Drawing >

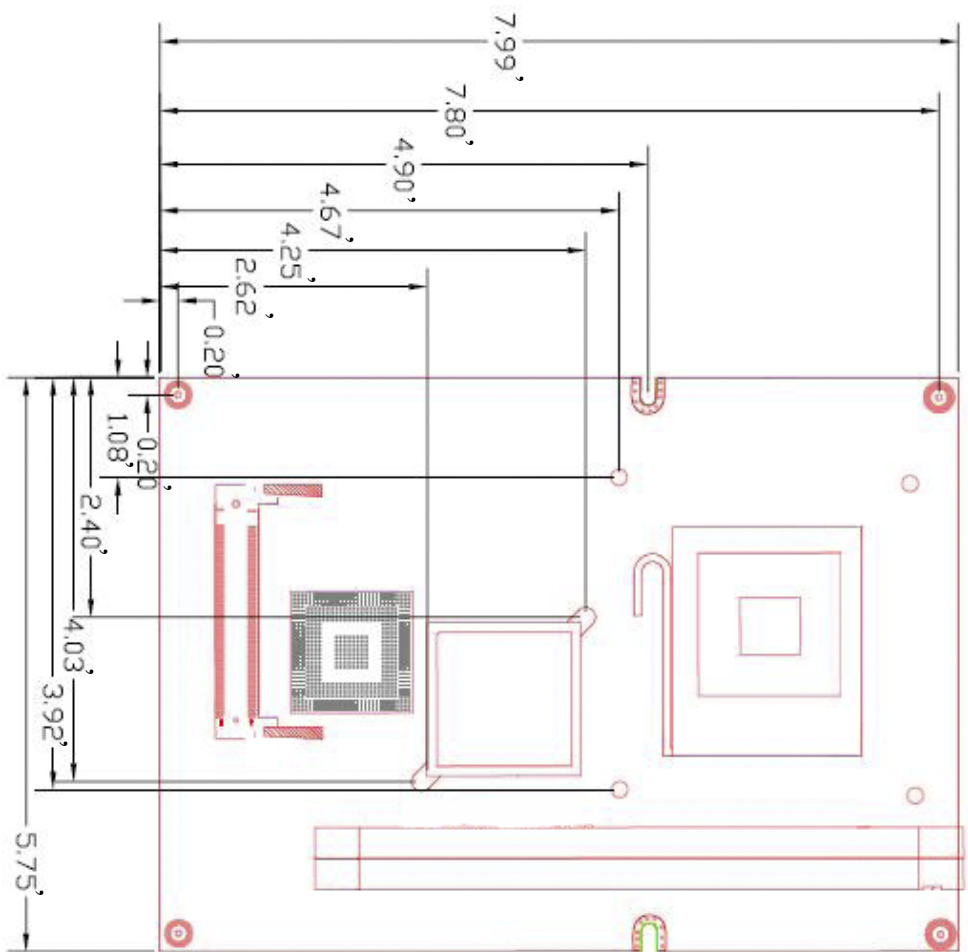

## 1.5 <Motherboard Dimension >

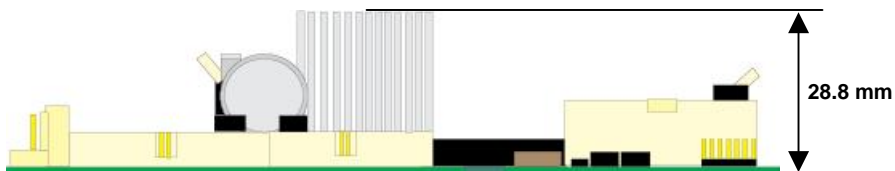
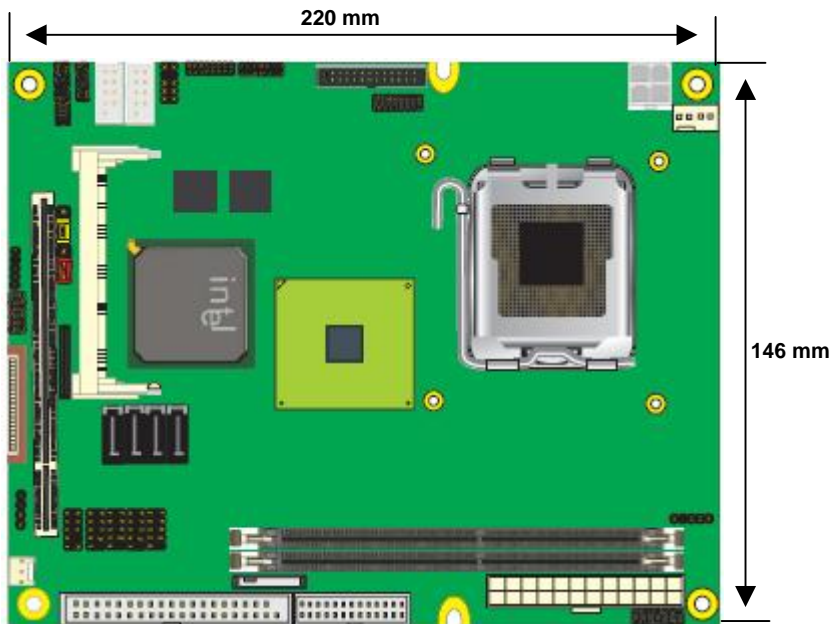

## Chapter 2 <Hardware Setup>

### 2.1 <Connector Location>

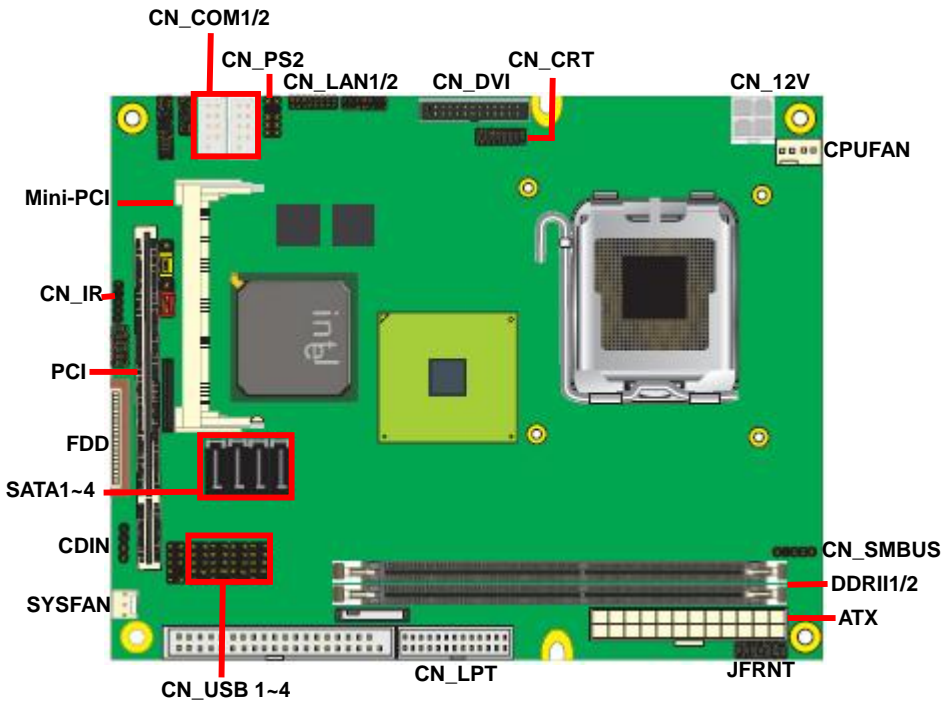

## 2.2 <Jumper Reference>

Jumper	Function
JRTC	CMOS Operating/Clear Setting
JVLCD	Panel Voltage Setting (3308120C Only)
JP1	COM1 Power mode
JP2	COM2 Power mode
JCSEL1	COM2 Function select
JCSEL2	RS232/422/485

JCSEL1/2 JP1/JP2

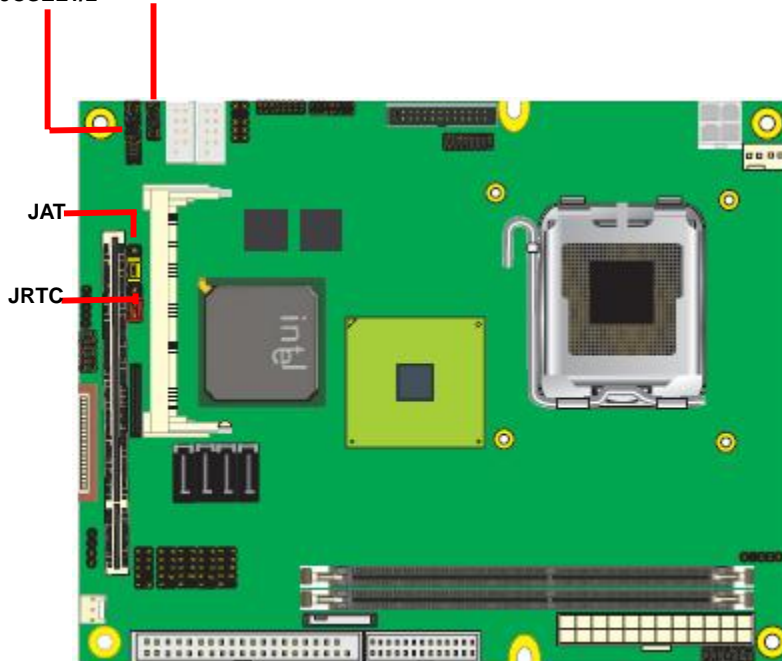



Jumper: **JAT**

Type: onboard 3-pin header

Power Mode	JAT
AT Mode	1-2
ATX Mode	2-3
Default setting: ATX Mode	

Jumper: **JP1 (COM 1)**

Type: onboard 3 x 2-pin header

Power Mode	JP1
Pin1 with 5V signal	1-3,4-6
Pin9 with 12V signal	2-4,3-5
Default setting: 3-5, 4-6	

Jumper: **JP2 (COM 2)**

Type: onboard 3 x 2-pin header

Power Mode	JP2
Pin1 with 5V signal	1-3,4-6
Pin9 with 12V signal	2-4,3-5
Default setting: 3-5, 4-6	

## 2.3 <Connector Reference>

### 2.3.1 <Internal Connectors>

Connector	Function	Remark
CPU	LGA775 CPU socket	
DDR11/2	240 -pin DDR2 SDRAM DIMM socket	
FDD	26-pin slim type floppy connector	
SATA11/2/3/4	7-pin Serial ATA II connector	
ATX	24-pin power supply connector	
CN_12V	4-pin +12V additional power supply connector	
CN_AUDIO	5 x 2-pin audio connector	
CDIN	4-pin CD-ROM audio input connector	
CN_DIO	6 x 2-pin digital I/O connector	
CN_USB	10-pin USB connector	
CPUFAN	4-pin CPU cooler fan connector	
SYSFAN	3-pin system cooler fan connector	
CN_IR	5-pin IrDA connector	
CN_INV	5-pin LCD inverter connector	3308120C
CN_LVDS	20 x 2-pin LVDS connector	3308120C
JFRNT	14-pin front panel switch/indicator connector	
PCI	120-Pin PCI socket	
Mini-PCI	Mini-PCI socket	
CN_DVI	26-Pin connector	3308120A & B
CN_COM2	5 x 2-pin com connector	

## 2.4 <CPU and Memory Setup>

### 2.4.1 <CPU installation>

3308120 has a LGA775 CPU socket onboard; please check following steps to install the processor properly.

**Attention** If 3308120 needs RMA please Keep CPU socket cover on the CPU Socket.

**Warning** Warranty void if CPU socket internal pin damage.



Intel® Core 2 Quad /Core 2 Duo/Celeron processor  
Package type: 775 pin LGA  
L2 Cache: 4 MB  
FSB: 800/1066/1333MHz (266MHz x 4)  
Manufacturing: 65 & 45 nm

1. Lift this bar

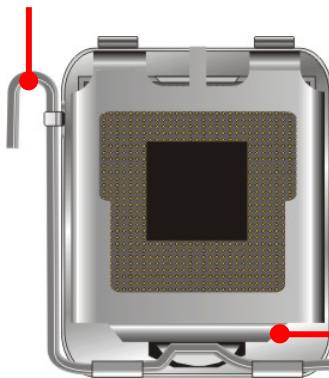

2. Uncover this plate



Check point

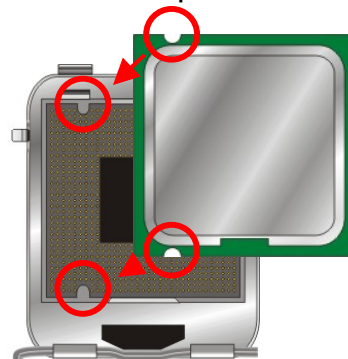

3. Place the CPU on the top of the pins



4. Lock this bar

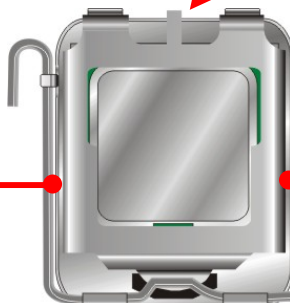

3. Cover this plate

**Notice:** Please place the CPU on the pins tenderly to avoid bending the pins

## 2.4.2 <Memory installation>

3308120 has two 240-pin DDR2 DIMM support up to 4GB of memory capacity. The memory frequency supports 667/800MHz.

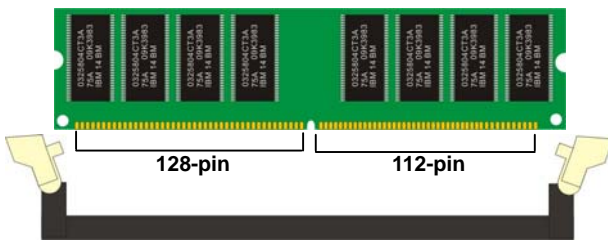
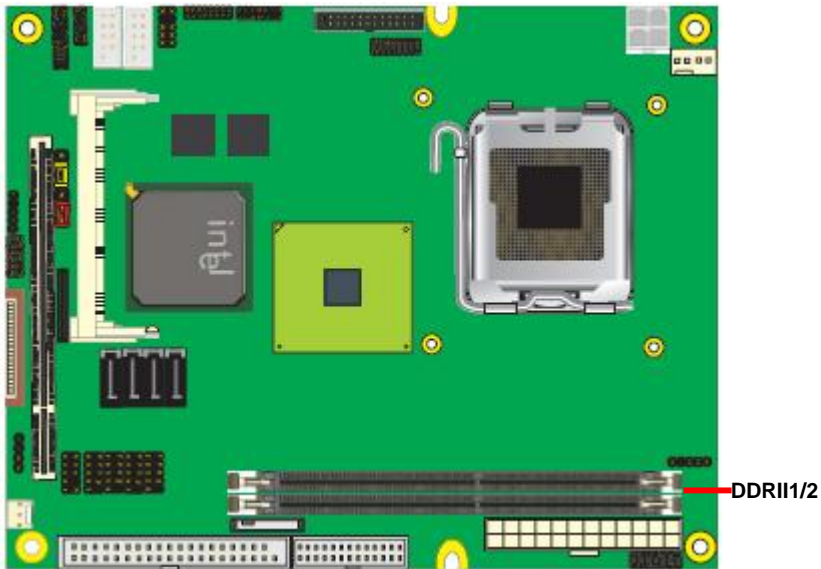

Please check the pin number to match the socket side well before installing memory module.

## 2.5 <CMOS Setup>

The board's data of CMOS can be setting in BIOS. If the board refuses to boot due to inappropriate CMOS settings, here is how to proceed to clear (reset) the CMOS to its default values.

**Jumper: JRTC**

**Type: Onboard 3-pin jumper**

JRTC	Mode
1-2	Clear CMOS
2-3	Normal Operation
Default setting	2-3

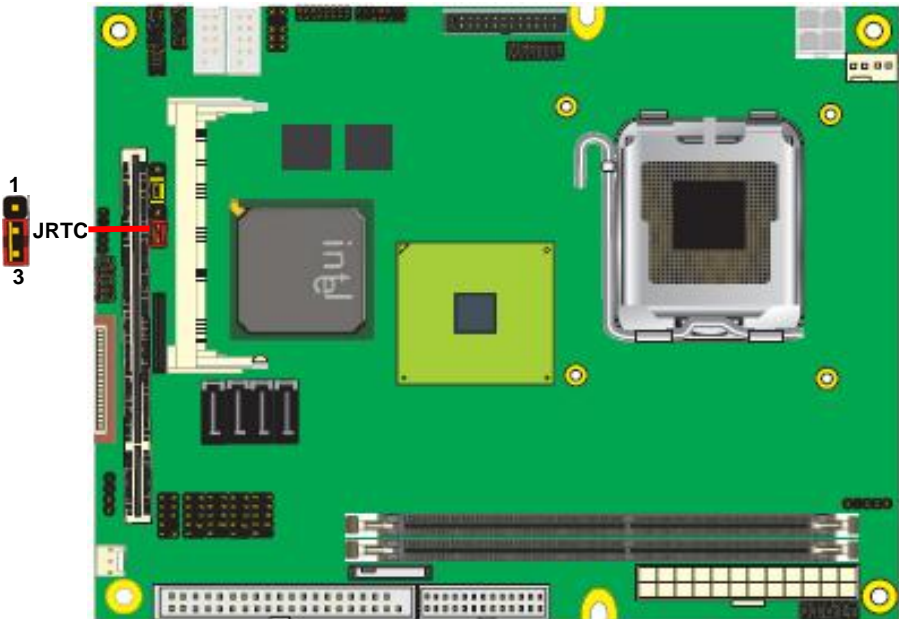

## 2.6 <Serial ATA installation>

3308120 has four Serial ATA II interfaces with RAID function, the transfer rate of the Serial ATA II can be up to 300MB/s. Please go to <http://www.serialata.org/> for more about Serial ATA technology information. Based on Intel® ICH9DO, it supports **Intel® Matrix Storage Technology** with combination of RAID 0,1,5 and 10. The main features of RAID on ICH9DO are listed below:

1. Supports for up to RAID volumes on a single, two-hard drive RAID array.
2. Supports for two, two-hard drive RAID arrays on any of six Serial ATA ports.
3. Supports for Serial ATA ATAPI devices.
4. Supports for RAID spares and automatic rebuild.
5. Supports on RAID arrays, including NCQ and native hot plug.

*For more information please visit Intel's official website.*

For more about the system setup for Serial ATA, please check the chapter of SATA configuration.

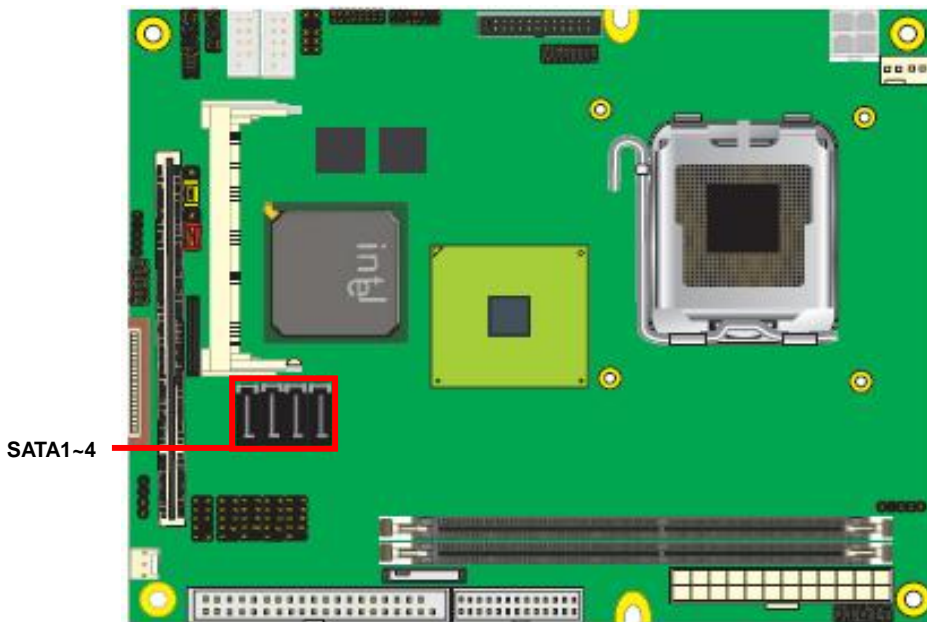

## 2.7 <Floppy Installation>

3308120 has one slim type 26-pin floppy interface, it supports notebook use floppy and powering from onboard, please follow up the steps below to install the device.

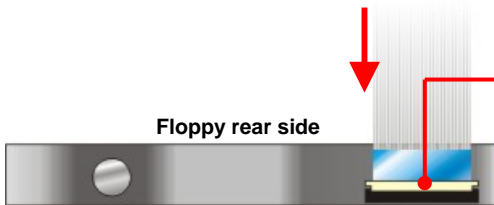
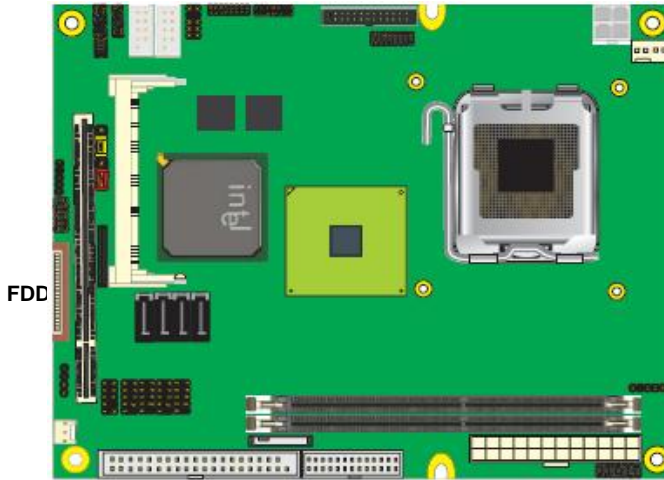

4. Lift up this plastic bar
5. Slot the cable in (Blue paste for outside)
6. Press back the plastic bar

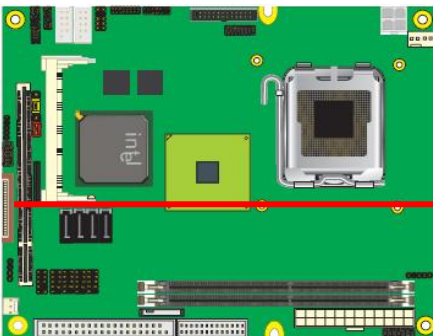

1. Lift up the brown plastic bar
2. Slot the cable in (Blue paste for brown bar side)
3. Press back the plastic bar

## 2.8 <LAN installation>

The board integrates with two Intel 82573L Gigabit Ethernet controllers, as the PCI bus with 133MB/s of transfer rate. The Intel 82573L supports triple speed of 10/100/1000Base-T, with IEEE802.3 compliance and Wake-On-LAN supported.

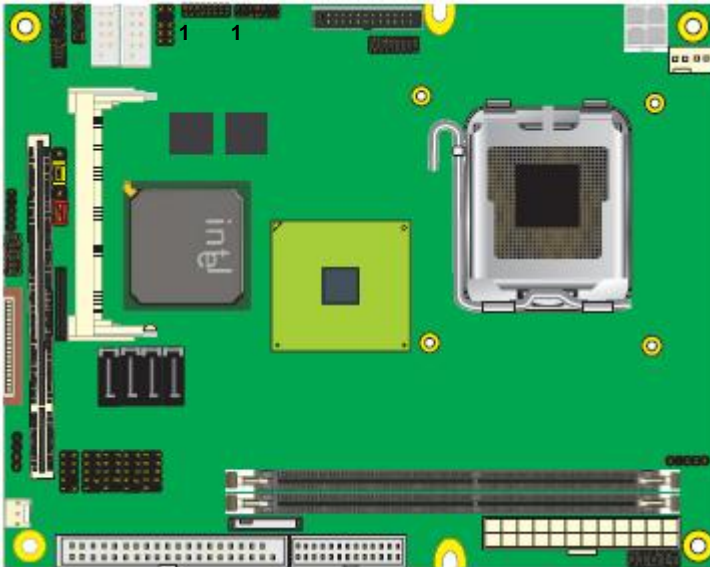
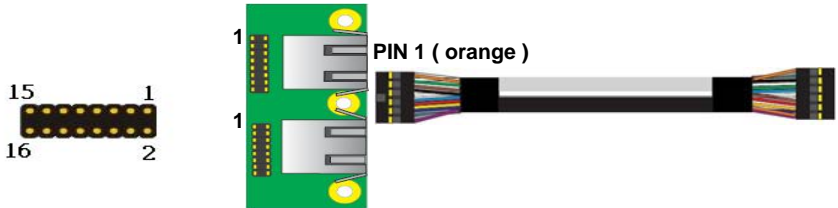



## **2.9 <Onboard Display Interface>**

Based on Intel Q35 chipset with built-in graphics, the board provides one DB15 connector on rear internal I/O port, and one 40-pin LVDS interface with 5-pin LCD backlight inverter connector. (3308120C Only)

The board also provides 26-pin DVI interface. (3308120A & B Only )

*Notice: When you install any PCI Graphic card, the onboard graphics would be disabled automatically.*

### **2.9.1 <Analog Display>**

Please connect your CRT or LCD monitor with DB15 male connector to the onboard DB15 female connector on rear I/O port.

### 2.9.2 <LVDS Display 3308120C Only >

The board provides one 40-pin LVDS connector for 18/24-bit dual channel panels, supports up to 1600 x 1200 (UXGA) of resolution, with one LCD backlight inverter connector and one jumper for panel voltage setting.

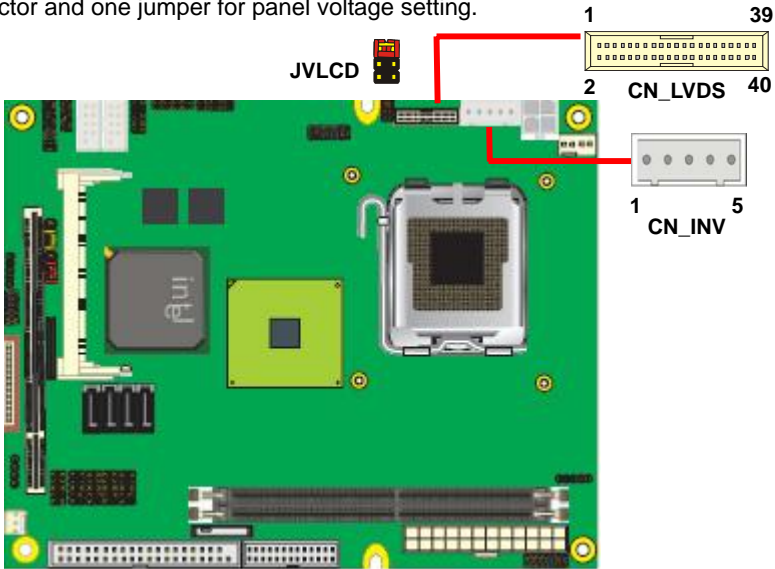

Connector: **CN\_INV**

Type: 5-pin LVDS Power Header

Pin	Description
1	+12V
2	GND
3	GND
4	GND
5	ENABKL

Connector: **JVLCD**

Type: 6-pin Power select Header

Pin	Description
1-2	LCDVCC (3.3V)
3-4	LCDVCC (5V)
5-6	VCC3 (12V)

Connector: **CN\_LVDS**

Type: onboard 40-pin connector for LVDS connector

Connector model: **HIROSE DF13-40DP-1.25V**

Pin	Signal	Pin	Signal
2	LCDVCC	1	LCDVCC
4	GND	3	GND
6	ATX0-	5	BTX0-
8	ATX0+	7	BTX0+
10	GND	9	GND
12	ATX1-	11	BTX1-
14	ATX1+	13	BTX1+
16	GND	15	GND
18	ATX2-	17	BTX2-
20	ATX2+	19	BTX2+
22	GND	21	GND
24	ACLK-	23	BTX3-
26	ACLK+	25	BTX3+
28	GND	27	GND
30	ATX3-	29	BCLK-
32	ATX3+	31	BCLK+
34	GND	33	GND
36	N/C	35	N/C
38	N/C	37	N/C
40	N/C	39	N/C

To setup the LCD, you need the component below:

1. A panel with LVDS interfaces.
2. An inverter for panel's backlight power.
3. A LCD cable and an inverter cable.

For the cables, please follow the pin assignment of the connector to make a cable, because every panel has its own pin assignment, so we do not provide a standard cable; please find a local cable manufacture to make cables.

### LCD Installation Guide:

1. Preparing the 3308120, LCD panel and the backlight inverter.

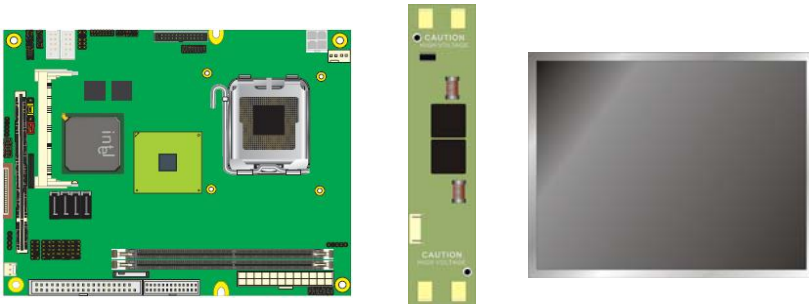

2. Please check the datasheet of the panel to see the voltage of the panel, and set the jumper **JVLCD** to +12V, 5V or +3.3V.
3. You would need a LVDS type cable.



4. To connect all of the devices well.

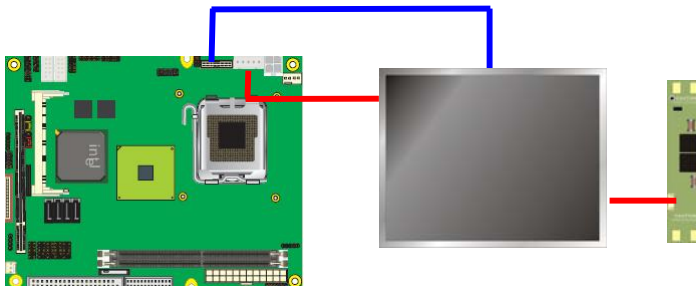

After setup the devices well, you need to select the LCD panel type in the BIOS.

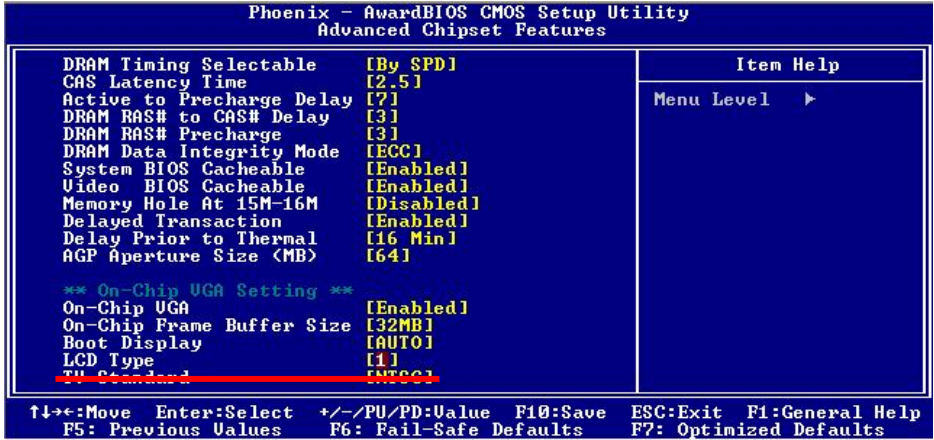

The panel type mapping is list below:

BIOS panel type selection form			
Single channel		Dual channel	
NO.	Output format	NO.	Output format
1	800 x 600 (18bit)	3	1280 x 1024 (24bit)
2	1024 x 768 (24bit)	4	1366 x 768 (24bit)

### 2.9.3 <DVI Display 3308120A & B Only >

The board provides optional DVI-D interface with Intel Q35, compliant with DVI 1.0 standard.

Connector: **CN\_DVI**

Connector type: 26-pin header connector (pitch = 2.54mm)

Pin Number	Assignment	Pin Number	Assignment
1	TX1+	2	TX1-
3	Ground	4	Ground
5	TXC+	6	TXC-
7	Ground	8	PVDD
9	N/C	10	N/C
11	TX2+	12	TX2-
13	Ground	14	Ground
15	TX0+	16	TX0-
17	N/C	18	HPDET
19	DDCDATA	20	DDCCLK
21	GND	22	N/C
23	N/C	24	N/C
25	N/C	26	N/C

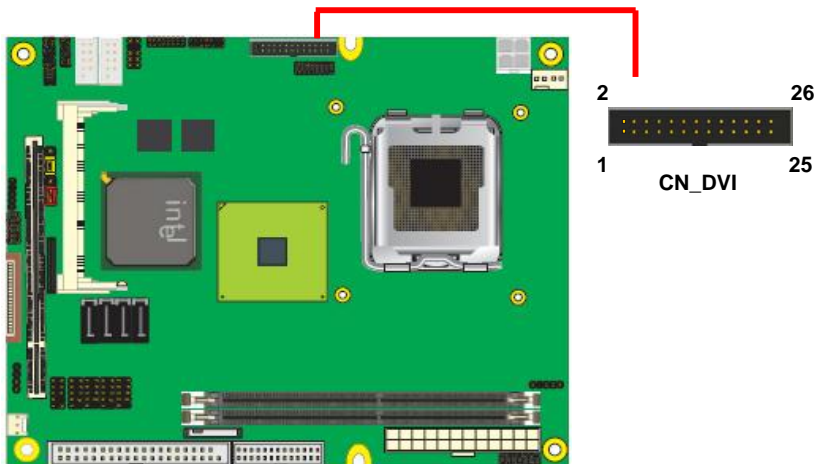

## 2.10 <Audio Installation>

The board integrates onboard audio interface with REALTEK ALC888 codec, with Intel next generation of audio standard as High Definition Audio, it offers more vivid sound and other advantages than former HD audio compliance.

The main specifications of ALC888 are:

- **High-performance DACs with 100dB S/N ratio**
- **One channel support 16/20/24-bit PCM format for 7.1 audio solution**
- **Compatible with HD**
- **Meets Microsoft WHQL/WLP 2.0 audio requirements**

The board provides 2 channels audio.

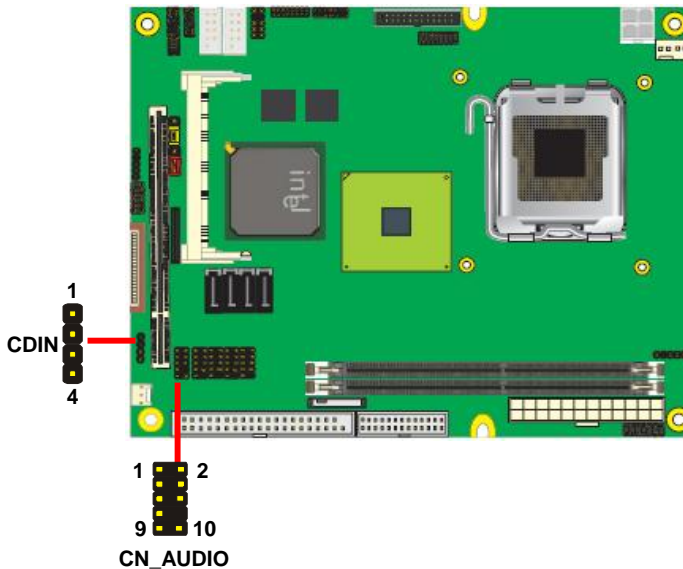

**Connector: CN\_AUDIO**

Type: 10-pin (2 x 5) header (pitch = 2.54mm)

Pin	Description	Pin	Description
1	MIC_L	2	Ground
3	MIC_R	4	ACZ_DET
5	Speaker_R	6	MIC Detect
7	SENSE	8	N/C
9	Speaker_L	10	Speaker Detect

**Connector: CDIN**

Type: 4-pin header (pitch = 2.54mm)

Pin	Description
1	CD – Left
2	Ground
3	Ground
4	CD – Right



## 2.11 <GPIO interface>

The board provides a programmable 8-bit digital I/O interface, and a SMBus (System management bus) interface for control panel application.

Connector: **CN\_DIO**

Type: onboard 2 x 6-pin header, pitch=2.0mm

Pin	Description	Pin	Description
1	Ground	2	Ground
3	GP10	4	GP14
5	GP11	6	GP15
7	GP12	8	GP16
9	GP13	10	GP17
11	VCC	12	+12V

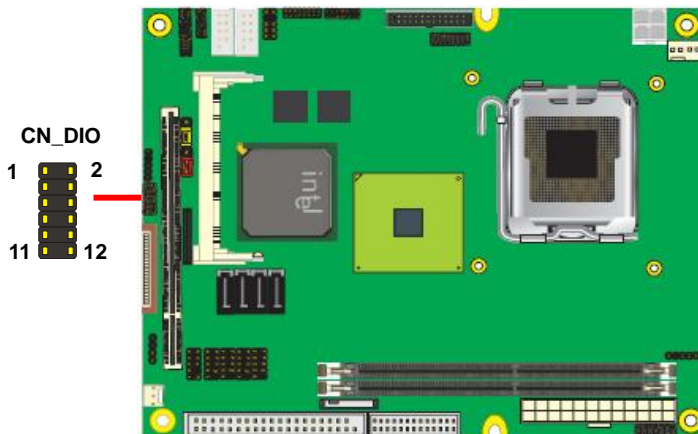

## 2.12 < USB Installation >

3308120 integrates eight USB2.0 ports. USB2.0 are listed below:

Interface	USB2.0
Controller	Intel ICH8DO
Transfer Rate	Up to 480Mb/s
Voltage	5V

The Intel® ICH9DO contains two Enhanced Host Controller Interface (EHCI) and five Universal Host Controller Interfaces (UHCI), it can determine whether your connected device is for USB1.1 or USB2.0, and change the transfer rate automatically.

Connector: **CN\_USB**

Type: 10-pin (5 x 2) header for USB5/6 Ports

Pin	Description	Pin	Description
1	VCC	2	VCC
3	Data0-	4	Data1-
5	Data0+	6	Data1+
7	Ground	8	Ground
9	Ground	10	N/C

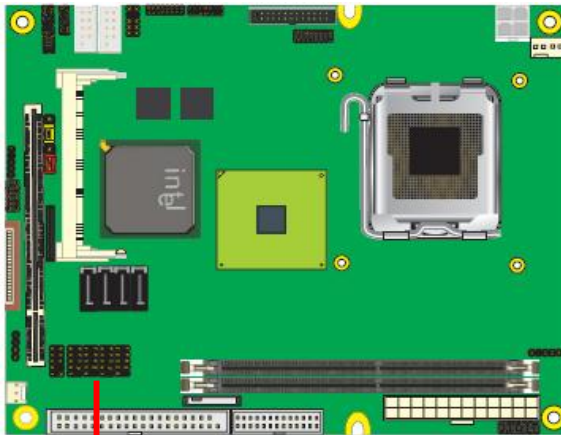

**CN\_USB**

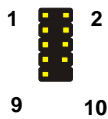

## 2.13 <Power and Fan Installation>

The 3308120 provides a standard ATX power supply with 24-pin ATX connector and additional 12V connector, and the board provides one 4-pin fan connectors supporting smart fan for CPU cooler and one 3-pin cooler fan connectors for system and Northbridge chip. The 4-pin CN\_12V additional power connector is necessary for CPU powering; please connect this well before you finishing the system setup.

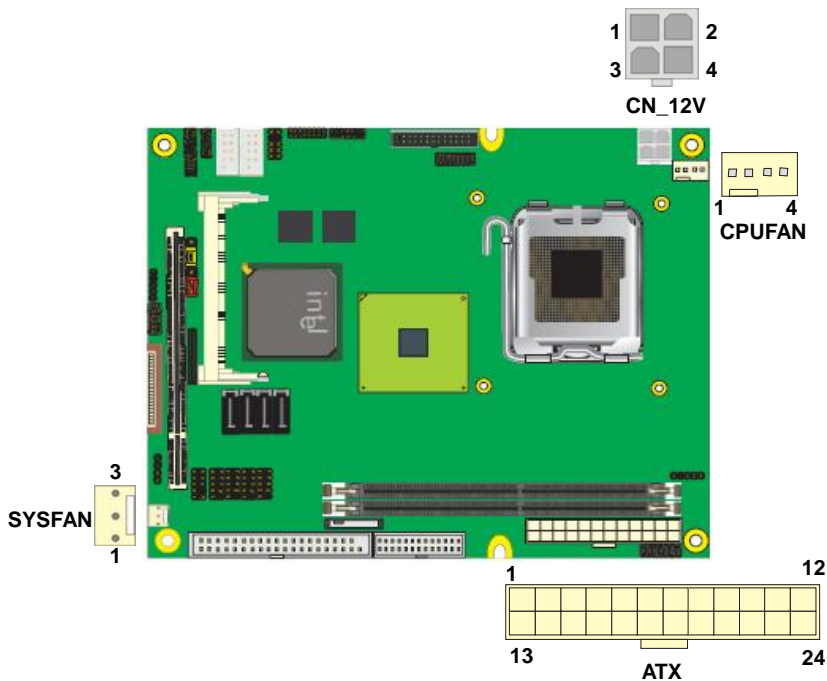

Connector: **ATX**

Type: 24-pin ATX power connector

PIN assignment			
1	3.3V	13	3.3V
2	3.3V	14	-12V
3	GND	15	GND
4	5V	16	PS_ON
5	GND	17	GND
6	5V	18	GND
7	GND	19	GND
8	PW_OK	20	-5V
9	5V_SB	21	5V
10	12V	22	5V
11	12V	23	5V
12	3.3V	24	GND

Connector: **CN\_12V**

Type: 4-pin standard Pentium 4 additional +12V power connector

Pin	Description	Pin	Description
1	Ground	2	Ground
3	+12V	4	+12V

Connector: **CPUFAN**

Type: 4-pin fan wafer connector

Pin	Description	Pin	Description
1	Ground	2	+12V
3	Fan Speed Detection	4	Fan Control

Connector: **SYSFAN**

Type: 3-pin fan wafer connector

Pin	Description	Pin	Description	Pin	Description
1	Ground	2	+12V	3	Sense

## 2.14 <Serial Port>

The board supports one RS232 serial port and one jumper selectable RS232/422/485 serial ports. The jumper JCSEL1 & JCSEL2 can let you configure the communicating modes for COM2.

Connector: **CN\_COM2**

Type: 10-pin (5 x 2) 2.54mm x 2.54mm-pitch header for COM2

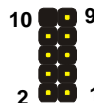

Pin	Description	Pin	Description
1	DCD/422TX-/485-	2	RXD/422TX+/485+
3	TXD/422RX+	4	DTR/422RX-
5	GND	6	DSR
7	RTS	8	CTS
9	RI	10	N/C

Function	JCSEL1	JCSEL2
IrDA		
RS-422		
RS-485		
RS-232		

## 2.15 <Switch and Indicator>

The **JFRNT** provides front control panel of the board, such as power button, reset and beeper, etc. Please check well before you connecting the cables on the chassis.

Connector: **JFRNT**

Type: onboard 14-pin (2 x 7) 2.54-pitch header

Function	Signal	PIN		Signal	Function
IDE LED	HDLED+	1	2	PWDLED+	Power LED
	HDLED-	3	4	N/C	
Reset	Reset+	5	6	PWDLED-	Speaker
	Reset-	7	8	SPKIN+	
N/C		9	10	N/C	
Power Button	PWRBT+	11	12	N/C	
	PWRBT-	13	14	SPKIN-	

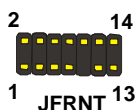
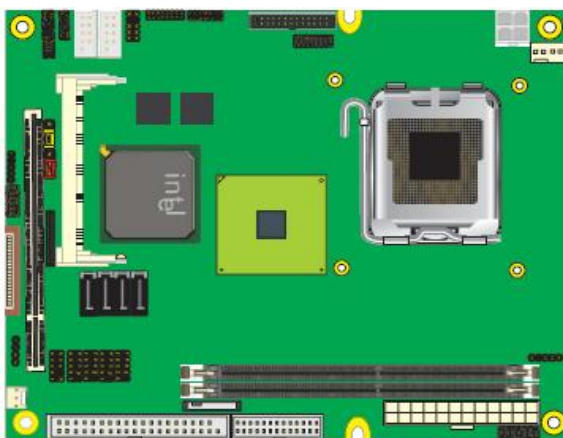

(This Page is Left for Blank)



## Chapter 3 <System Configuration>

### 3.1 <SATA configuration>

#### SATA Mode:

This option can let you select whether the Serial ATA hard drives would work under normal IDE mode or RAID mode. The RAID mode need more than one HDD is applied.

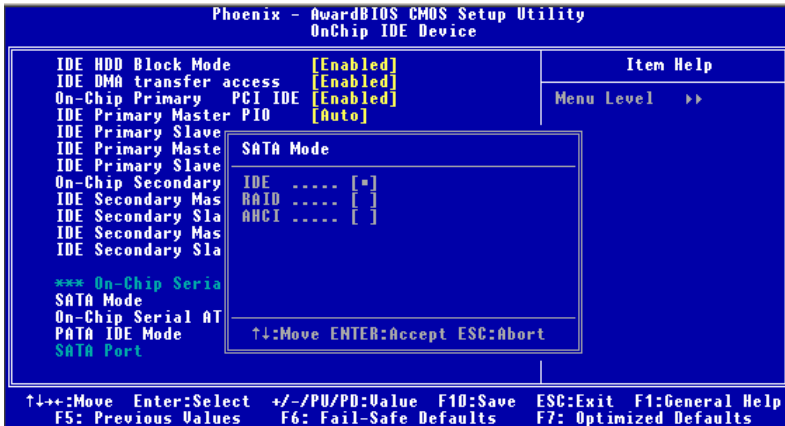

## 3.2 <SATA RAID Configuration>

The board integrates Intel® ICH8DO with RAID function for Serial ATA II drives, and supports the configurations below:

**RAID 0 (Striping):** Two hard drives operating as one drive for optimized data R/W performance. It needs two unused drives to build this operation.

**RAID 1 (Mirroring):** Copies the data from first drive to second drive for data security, and if one drive fails, the system would access the applications to the workable drive. It needs two unused drives or one used and one unused drive to build this operation. The second drive must be the same or larger size than first one.

### **RAID 5 (striping with parity)**

A RAID 5 array contains three or more hard drives where the data is divided into manageable blocks called strips. Parity is a mathematical method for recreating data that was lost from a single drive, which increases fault-tolerance. The data and parity are striped across all the hard drives in the array. The parity is striped in a rotating sequence to reduce bottlenecks associated with the parity calculations.

### **RAID 10 (RAID 0+1)**

A RAID 10 array uses four hard drives to create a combination of RAID levels 0 and 1. The data is striped across a two-drive array forming the RAID 0 component. Each of the drives in the RAID 0 array is then mirrored by a RAID 1 component.

**Intel Matrix Storage Technology:** This technology would allow you to use **RAID 0+1** mode on only two drives (4 drives needed on traditional RAID 0+1). It will create two partitions on each hard drive to simulate **RAID 0** and **RAID 1**. It also can let you modify the partition size without re-formatted.

*For more information of Intel Matrix Storage Technology, please visit Intel's website.*

If you need to install an operation system on the RAID set, please use the driver disk attached in the package when it informs you to obtain the RAID drivers.

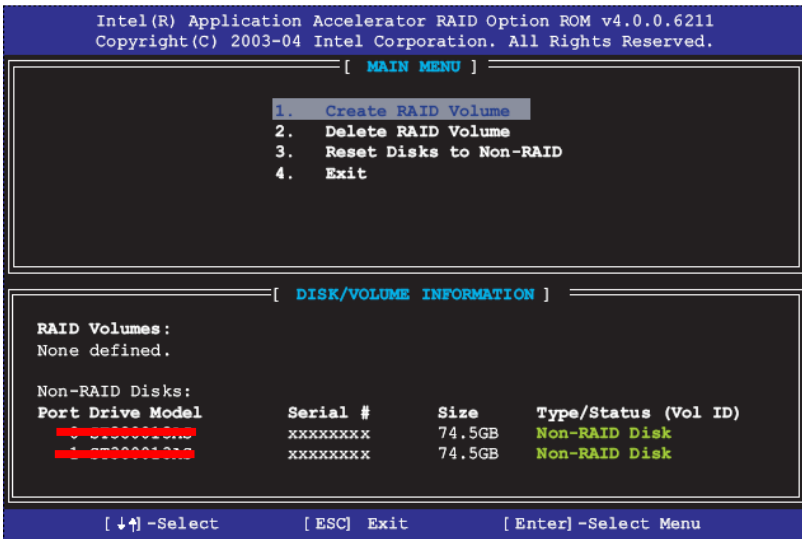

Please press <CTRL+I> to enter the RAID configuration menu.

You can setup the RAID under operation system for Microsoft® Windows XP SP1 or Windows 2000 SP4 version, please install the Intel® Application Accelerator Ver.4.5 later to support RAID configuration with Intel® Matrix Storage Technology.

1. After installing Intel Application Accelerator, please execute Intel® Storage Utility.

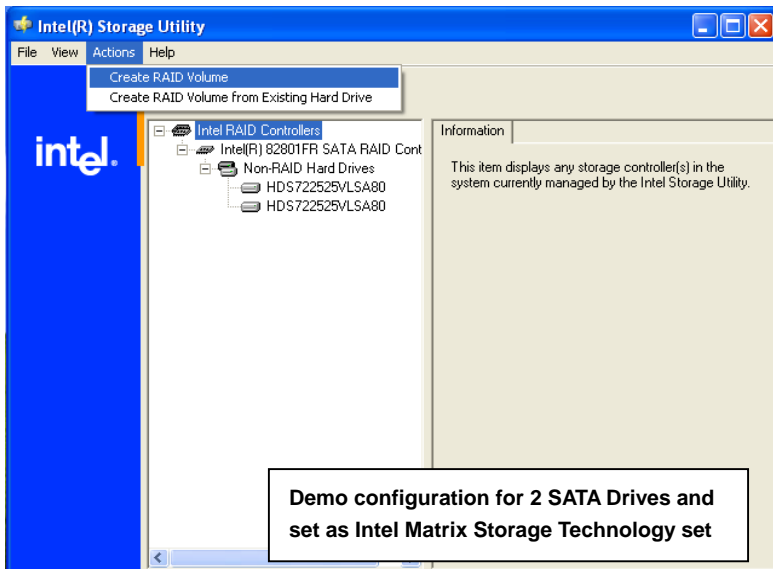

2. Select Actions to Create RAID Volume

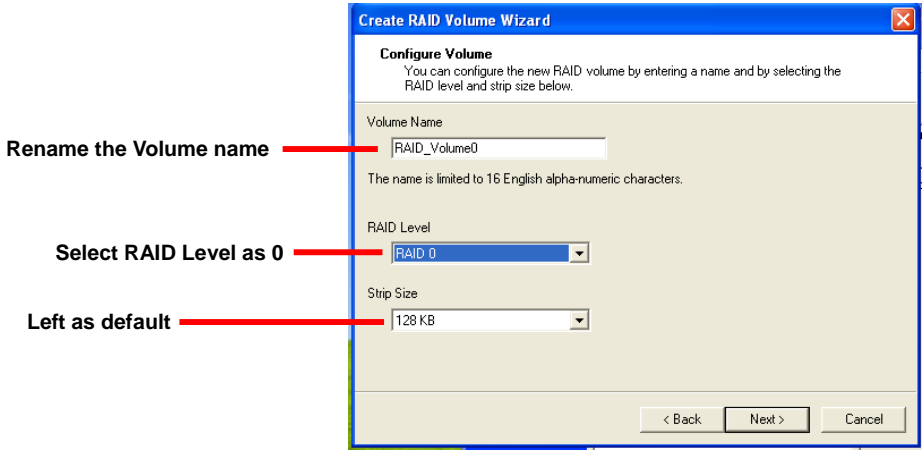

3. Please select two hard drives to prepare to set the RAID volume

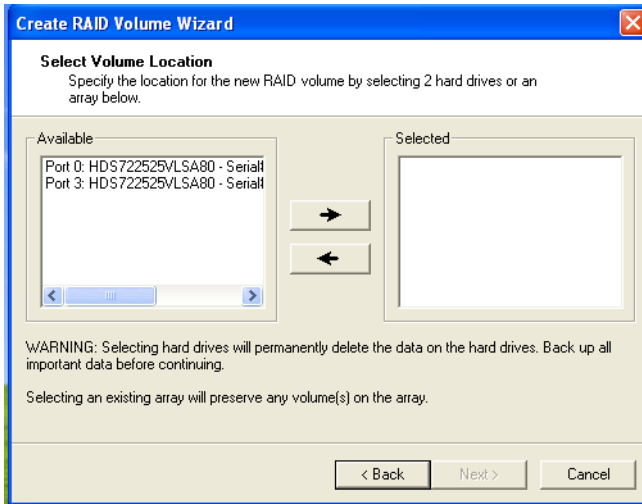

4. Specify the Volume size

**Tune this bar to specify the volume size, if you specify the volume size lower than maximum, you can create a second volume for another RAID set. (Make RAID 0+1 on only two hard drives)**

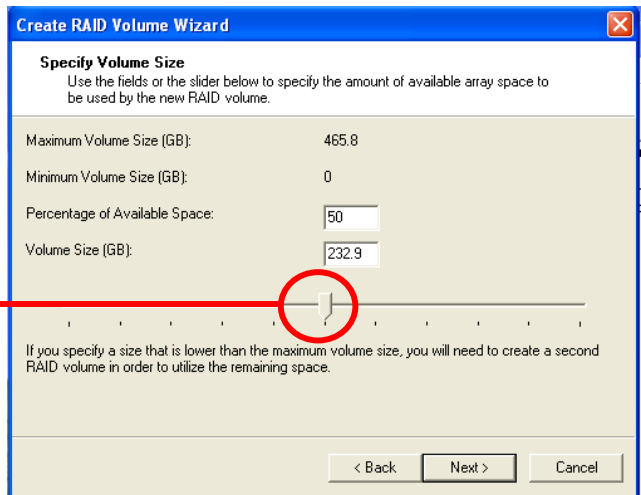

5. Repeat the step 1 to create second volume as RAID Level 1.

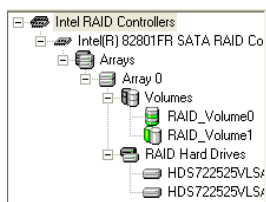

**For other configuration set please click Help on tool bar.**

### 3.3 <Audio Configuration>

The board integrates Intel® ICH8DO with REALTEK® ALC888 codec. It can support 2-channel sound under system configuration. Please follow the steps below to setup your sound system.

1. Install REALTEK HD Audio driver.



2. Launch the control panel and Sound Effect Manager.
3. Select Speaker Configuration



4. Select the sound mode to meet your speaker system.

### 3.4 <Video Memory Setup>

Based on Intel® Q35 chipset with GMA (Graphic Media Accelerator) 3000, the board supports Intel® DVMT (Dynamic Video Memory Technology) 3.0, which would allow the video memory be triggered up to 384MB.

To support DVMT, you need to install the Intel GMA 3000 Driver with supported OS.

#### BIOS Setup:

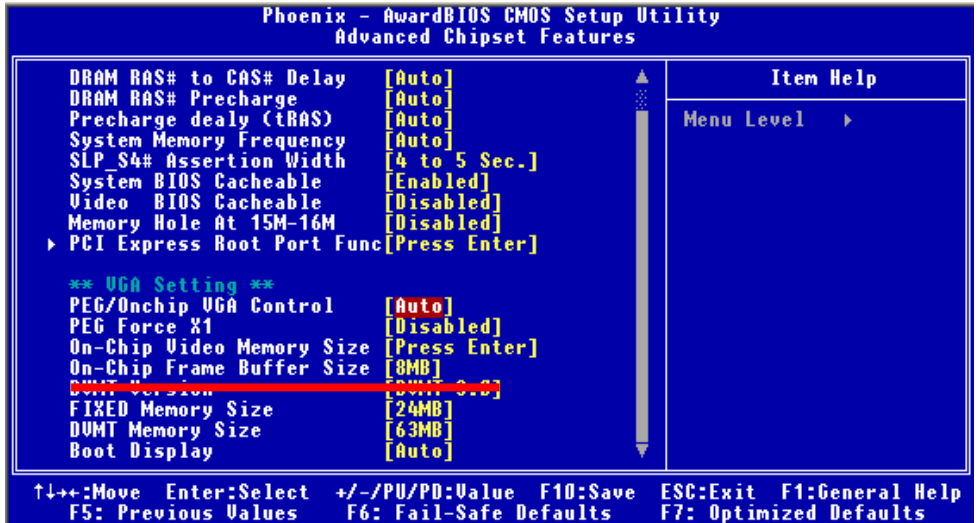

**On-Chip Video Memory Size:** This option combines three items below for setup.

#### On-Chip Frame Buffer Size:

This item can let you select video memory which been allocated for legacy VGA and SVGA graphics support and compatibility. The available option is **1MB** and **8MB**.

#### Fixed Memory Size:

This item can let you select a static amount of page-locked graphics memory which will be allocated during driver initialization. Once you select the memory amount, it will be no longer available for system memory.

#### DVMT Memory Size:

This item can let you select a maximum size of dynamic amount usage of video memory, the system would configure the video memory depends on your application, this item is strongly recommend to be selected as **MAX DVMT**.



**Fixed + DVMT Memory Size:**

You can select the fixed amount and the DVMT amount at the same time for a guaranteed video memory and additional dynamic video memory, please check the table below for available setting.

System Memory	On-Chip Frame Buffer Size	Fixed Memory Size	DVMT Memory Size	Total Graphic Memory
256MB ~ 511MB	1MB	128MB	0MB	128MB
	1MB	0MB	128MB	128MB
	8MB	128MB	0MB	128MB
	8MB	0	128MB	128MB
512MB~1023MB	1MB	128MB	0	128MB
	1MB	256MB	0	256MB
	1MB	0	128MB	128MB
	1MB	0	256MB	256MB
	8MB	128MB	0	128MB
	8MB	256MB	0	256MB
	8MB	0	128MB	128MB
	8MB	0	256MB	256MB
1024MB upper	1MB	128MB	0	128MB
	1MB	256MB	0	256MB
	1MB	0	128MB	128MB
	1MB	0	256MB	256MB
	1MB	0	MAX	384MB
	8MB	128MB	0	128MB
	8MB	256MB	0	256MB
	8MB	0	128MB	128MB
	8MB	0	256MB	256MB
8MB	0	MAX	384MB	

Notice:

1. The On-Chip Frame Buffer Size would be included in the Fixed Memory.
2. Please select the memory size according to this table.

## 3.5 <Display Properties Setting>

Based on Intel GM(E)965 GMCH with GMA X3100 (Graphic Media Accelerator), the board supports two DACs for display device as different resolution and color bit.

Please install the Intel Graphic Driver before you starting setup display devices.

1. Click right button on the desktop to lunch **display properties**

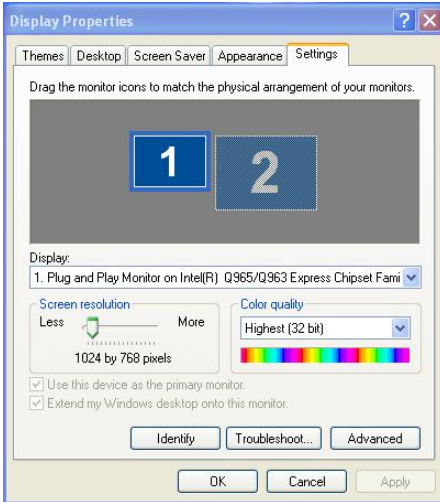

2. Click **Advanced** button for more specificity setup.

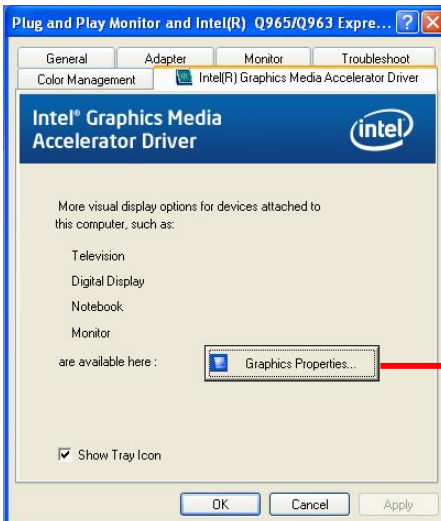

Click Graphics Properties... for advanced setup

3. This setup options can let you define each device settings.

Click **Monitor** to setup the CRT monitor for Colors, Resolution and Refresh Rate

Click **Intel® Dual Display Clone** to setup the dual display mode as same screen

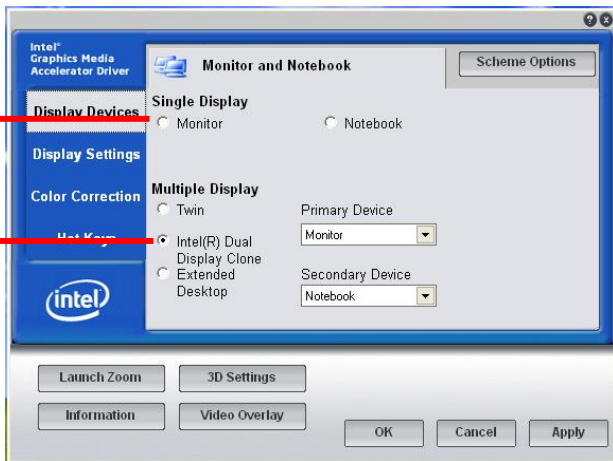

Set the main display device here

Click **Extended Desktop** to setup the dual display mode as different screen display

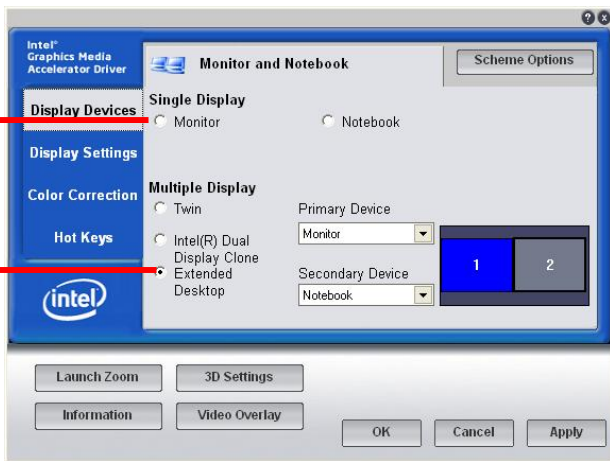

## Chapter 4 <BIOS Setup>

The motherboard uses the Award BIOS for the system configuration. The Award BIOS in the single board computer is a customized version of the industrial standard BIOS for IBM PC AT-compatible computers. It supports Intel x86 and compatible CPU architecture based processors and computers. The BIOS provides critical low-level support for the system central processing, memory and I/O sub-systems.

The BIOS setup program of the single board computer let the customers modify the basic configuration setting. The settings are stored in a dedicated battery-backed memory, NVRAM, retains the information when the power is turned off. If the battery runs out of the power, then the settings of BIOS will come back to the default setting.

The BIOS section of the manual is subject to change without notice and is provided here for reference purpose only. The settings and configurations of the BIOS are current at the time of print, and therefore they may not be exactly the same as that displayed on your screen.

To activate CMOS Setup program, press <DEL> key immediately after you turn on the system. The following message "Press DEL to enter SETUP" should appear in the lower left hand corner of your screen. When you enter the CMOS Setup Utility, the Main Menu will be displayed as **Figure 4-1**. You can use arrow keys to select your function, press <Enter> key to accept the selection and enter the sub-menu.

**Figure 4-1** CMOS Setup Utility Main Screen

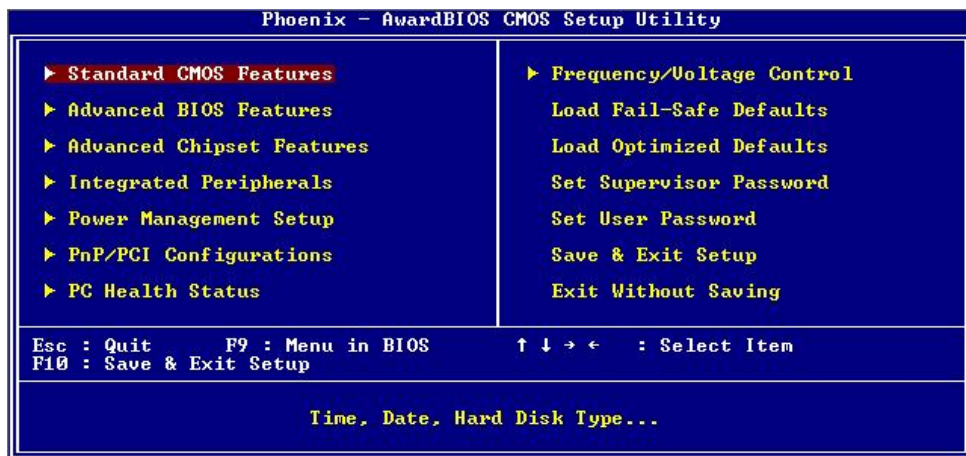

(This Page is Left for Blank)

## Appendix A <I/O Port Pin Assignment>

### A.1 <Serial ATA Port>

Connector: **SATA1/2/3/4**

Type: 7-pin wafer connector

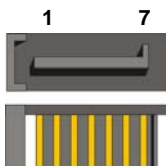

1	2	3	4	5	6	7
GND	RSATA_TXP1	RSATA_TXN1	GND	RSATA_RXN1	RSATA_RXP1	GND

### A.2 <Floppy Port>

Connector: **FDD**

Type: 26-pin connector



Pin	Description	Pin	Description
1	VCC	2	INDEX
3	VCC	4	DRV0
5	VCC	6	DSKCHG
7	DRV1	8	N/C
9	MTR1	10	MTR0
11	RPM	12	DIR
13	N/C	14	STEP
15	Ground	16	WRITE DATA
17	Ground	18	WRITE GATE
19	N/C	20	TRACK 0
21	N/C	22	WRPTR
23	Ground	24	RDATA-
25	Ground	26	SEL

### A.3 <IrDA Port>

Connector: **CN\_IR**

Type: 5-pin header for SIR Ports



Pin	Description
1	VCC
2	N/C
3	IRRX
4	Ground
5	IRTX

### A.4 <VGA Port>

Connector: **CN\_CRT**

Type: 16-pin (2 x 8) 2.0-pitch pin header



Pin	Description	Pin	Description
1	Red	9	Green
2	Blue	10	N/C
3	Ground	11	Ground
4	Ground	12	Ground
5	N/C	13	Ground
6	N/C	14	Data
7	HSYNC	15	VSYNC
8	Clock	16	N/C

### A.5 <LAN Port>

Connector: **RJ45**

Type: RJ45 connector with LED on bracket

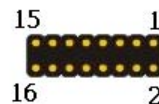

Pin	1	2	3	4	5	6	7	8
Description	MI0+	MI0-	MI1+	MI2+	MI2-	MI1-	MI3+	MI3-

Connector: **CN\_LAN**

Type: 16-pin (8 x 2) header for LAN Ports

Pin	Description	Pin	Description
1	RTD4+	2	RTD5-
3	RTD4-	4	RTD5+
5	N/C	6	Ground
7	RTD6+	8	RTD7+
9	RTD6-	10	RTD7-
11	Ground	12	Ground
13	RLINK1	14	RLINK1H1-
15	RACTLED1	16	RLINK1G1-

## A.6 <SMBUS Port>

Connector: **CN\_SMBUS**

Type: 5-pin header for SMBUS Ports

Pin	Description
1	V5S
2	N/C
3	SMBDATA
4	SMBCLK
5	Ground



## A.7 <Serial Port 1>

Connector: **COM1**

Type: 9-pin D-sub male connector on bracket

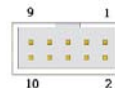

Pin	Description	Pin	Description
1	DCD- /+5V	6	DSR
2	SIN-	7	RTS
3	SO-	8	CTS
4	DTR-	9	RI /+12V
5	Ground		



## A.8 <Serial Port 2>

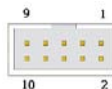

Connector: **COM2**

Type: 9-pin header connector on bracket

Pin	Description	Pin	Description
1	DCD- /485- /+5V	6	DSR
2	SIN- /485+	7	RTS
3	SO- /422+	8	CTS
4	DTR- /422-	9	RI /+12V
5	Ground		

## A.9 <Parallel Port>

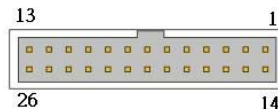

Connector: **LPT**

Type: 26-Pin header Connector on bracket

Pin	Description	Pin	Description
1	-PSTB	2	PRO0
3	PRO1	4	PRO2
5	PRO3	6	PRO4
7	PRO5	8	PRO6
9	PRO7	10	ACK-
11	BUSY	12	PE
13	SLCT	14	AFD-
15	ERR-	16	INT-
17	SLIN-	18	Ground
19	Ground	20	I/O Ground
21	Ground	22	Ground
23	Ground	24	Ground
25	Ground	26	N/C

## A.10 <COM 3/4/5/6Port>

Connector: **COM 3/4/5/6**

Type: header Connector on bracket

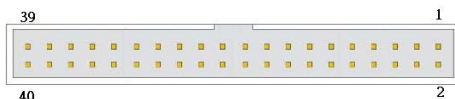







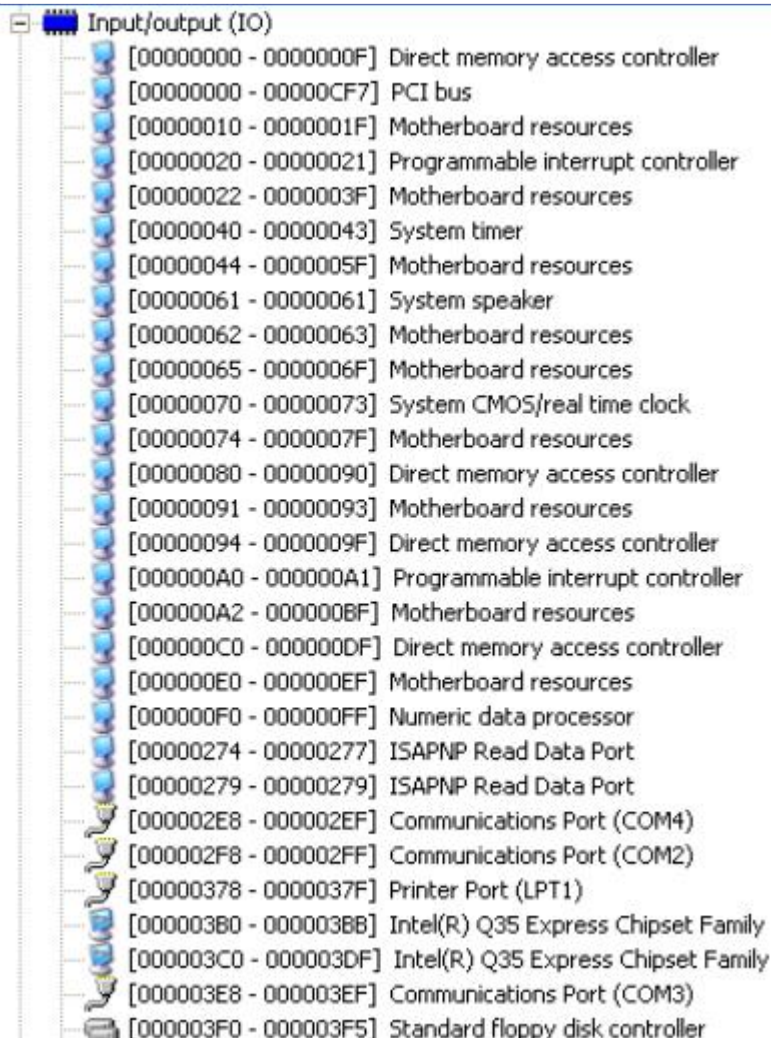













Pin	Description	Pin	Description	Pin	Description
1	HS_DCD1	15	Ground	29	HS_RI3-
2	HS_RXD1	16	HS_DSR2-	30	N/C
3	HS_TXD1	17	HS_RTS2-	31	HS_DCD4-
4	HS_DTR1-	18	HS_CTS2-	32	HS_RXD4
5	Ground	19	HS_RI2-	33	HS_TXD4
6	HS_DSR1-	20	N/C	34	HS_DTR4-
7	HS_RTS1-	21	HS_DCD3-	35	Ground
8	HS_CTS1-	22	HS_RXD3	36	HS_DSR4-
9	HS_RI1-	23	HS_TXD3	37	HS_RTS4-
10	N/C	24	HS_DTR3-	38	HS_CTS4-
11	HS_DCD2-	25	Ground	39	HS_RI4-
12	HS_RXD2	26	HS_DSR3-	40	N/C
13	HS_TXD2	27	HS_RTS3-		
14	HS_DTR2-	28	HS_CTS3-		

## Appendix B <System Resources>

### B1.<I/O Port Address Map>



Address Range	Device Name
[00000000 - 0000000F]	Direct memory access controller
[00000000 - 00000CF7]	PCI bus
[00000010 - 0000001F]	Motherboard resources
[00000020 - 00000021]	Programmable interrupt controller
[00000022 - 0000003F]	Motherboard resources
[00000040 - 00000043]	System timer
[00000044 - 0000005F]	Motherboard resources
[00000061 - 00000061]	System speaker
[00000062 - 00000063]	Motherboard resources
[00000065 - 0000006F]	Motherboard resources
[00000070 - 00000073]	System CMOS/real time clock
[00000074 - 0000007F]	Motherboard resources
[00000080 - 00000090]	Direct memory access controller
[00000091 - 00000093]	Motherboard resources
[00000094 - 0000009F]	Direct memory access controller
[000000A0 - 000000A1]	Programmable interrupt controller
[000000A2 - 000000BF]	Motherboard resources
[000000C0 - 000000DF]	Direct memory access controller
[000000E0 - 000000EF]	Motherboard resources
[000000F0 - 000000FF]	Numeric data processor
[00000274 - 00000277]	ISAPNP Read Data Port
[00000279 - 00000279]	ISAPNP Read Data Port
[000002E8 - 000002EF]	Communications Port (COM4)
[000002F8 - 000002FF]	Communications Port (COM2)
[00000378 - 0000037F]	Printer Port (LPT1)
[00000380 - 0000038B]	Intel(R) Q35 Express Chipset Family
[000003C0 - 000003DF]	Intel(R) Q35 Express Chipset Family
[000003E8 - 000003EF]	Communications Port (COM3)
[000003F0 - 000003F5]	Standard floppy disk controller









	[00000378 - 0000037F] Printer Port (LPT1)
	[00000380 - 000003BB] Intel(R) Q35 Express Chipset Family
	[000003C0 - 000003DF] Intel(R) Q35 Express Chipset Family
	[000003E8 - 000003EF] Communications Port (COM3)
	[000003F0 - 000003F5] Standard floppy disk controller
	[000003F7 - 000003F7] Standard floppy disk controller
	[000003F8 - 000003FF] Communications Port (COM1)
	[00000400 - 000004BF] Motherboard resources
	[000004D0 - 000004D1] Motherboard resources
	[000004E8 - 000004EF] Communications Port (COM6)
	[000004F8 - 000004FF] Communications Port (COM5)
	[00000500 - 0000051F] Intel(R) ICH9 Family SMBus Controller - 2930
	[00000778 - 0000077B] Printer Port (LPT1)
	[00000880 - 0000088F] Motherboard resources
	[00000A79 - 00000A79] ISAPNP Read Data Port
	[00000D00 - 0000FFFF] PCI bus
	[00007000 - 00007FFF] Intel(R) ICH9 Family PCI Express Root Port 3 - 2944
	[00008000 - 00008FFF] Intel(R) ICH9 Family PCI Express Root Port 2 - 2942
	[00008F00 - 00008F1F] Intel(R) PRO/1000 PL Network Connection #2
	[00009000 - 00009FFF] Intel(R) ICH9 Family PCI Express Root Port 1 - 2940
	[00009F00 - 00009F1F] Intel(R) PRO/1000 PL Network Connection
	[0000A000 - 0000AFFF] Intel(R) ICH9 Family PCI Express Root Port 6 - 294A
	[0000B000 - 0000BFFF] Intel(R) ICH9 Family PCI Express Root Port 5 - 2948
	[0000C000 - 0000CFFF] Intel(R) ICH9 Family PCI Express Root Port 4 - 2946
	[0000EC00 - 0000EC0F] Intel(R) ICH9 2 port Serial ATA Storage Controller 2 - 2926
	[0000ED00 - 0000ED0F] Intel(R) ICH9 2 port Serial ATA Storage Controller 2 - 2926

	[0000B000 - 0000BFFF] Intel(R) ICH9 Family PCI Express Root Port 5 - 2948
	[0000C000 - 0000CFFF] Intel(R) ICH9 Family PCI Express Root Port 4 - 2946
	[0000EC00 - 0000EC0F] Intel(R) ICH9 2 port Serial ATA Storage Controller 2 - 2926
	[0000ED00 - 0000ED0F] Intel(R) ICH9 2 port Serial ATA Storage Controller 2 - 2926
	[0000EE00 - 0000EE03] Intel(R) ICH9 2 port Serial ATA Storage Controller 2 - 2926
	[0000EF00 - 0000EF07] Intel(R) ICH9 2 port Serial ATA Storage Controller 2 - 2926
	[0000F000 - 0000F003] Intel(R) ICH9 2 port Serial ATA Storage Controller 2 - 2926
	[0000F100 - 0000F107] Intel(R) ICH9 2 port Serial ATA Storage Controller 2 - 2926
	[0000F300 - 0000F30F] Intel(R) ICH9 4 port Serial ATA Storage Controller 1 - 2920
	[0000F400 - 0000F40F] Intel(R) ICH9 4 port Serial ATA Storage Controller 1 - 2920
	[0000F500 - 0000F503] Intel(R) ICH9 4 port Serial ATA Storage Controller 1 - 2920
	[0000F600 - 0000F607] Intel(R) ICH9 4 port Serial ATA Storage Controller 1 - 2920
	[0000F700 - 0000F703] Intel(R) ICH9 4 port Serial ATA Storage Controller 1 - 2920
	[0000F800 - 0000F807] Intel(R) ICH9 4 port Serial ATA Storage Controller 1 - 2920
	[0000F900 - 0000F91F] Intel(R) ICH9 Family USB Universal Host Controller - 2936
	[0000FA00 - 0000FA1F] Intel(R) ICH9 Family USB Universal Host Controller - 2935
	[0000FB00 - 0000FB1F] Intel(R) ICH9 Family USB Universal Host Controller - 2934
	[0000FC00 - 0000FC1F] Intel(R) ICH9 Family USB Universal Host Controller - 2939
	[0000FD00 - 0000FD1F] Intel(R) ICH9 Family USB Universal Host Controller - 2938
	[0000FE00 - 0000FE1F] Intel(R) ICH9 Family USB Universal Host Controller - 2937
	[0000FF00 - 0000FF07] Intel(R) Q35 Express Chipset Family























## B2.<Memory Address Map>



Memory Address Range	Device Name
[00000000 - 0009FFFF]	System board
[0000046E - 0000056D]	System board
[000A0000 - 000BFFFF]	Intel(R) Q35 Express Chipset Family
[000A0000 - 000BFFFF]	PCI bus
[000C0000 - 000DFFFF]	PCI bus
[000E0000 - 000EFFFF]	System board
[000F0000 - 000FFFFF]	System board
[00100000 - 3F5DFFFF]	System board
[3F5E0000 - 3F5FFFFF]	System board
[3F600000 - 3F6FFFFF]	System board
[3F650000 - FEBFFFFF]	PCI bus
[D0000000 - DFFFFFFF]	Intel(R) Q35 Express Chipset Family
[E0000000 - EFFFFFFF]	Motherboard resources
[FCF00000 - FCF7FFFF]	Intel(R) ICH9 Family PCI Express Root Port 1 - 2940
[FD000000 - FD07FFFF]	Intel(R) ICH9 Family PCI Express Root Port 1 - 2940
[FD0E0000 - FD0EFFFF]	Intel(R) PRO/1000 PL Network Connection
[FD300000 - FD37FFFF]	Intel(R) Q35 Express Chipset Family
[FD400000 - FD47FFFF]	Intel(R) ICH9 Family PCI Express Root Port 6 - 294A
[FD500000 - FD57FFFF]	Intel(R) ICH9 Family PCI Express Root Port 6 - 294A
[FD600000 - FD67FFFF]	Intel(R) ICH9 Family PCI Express Root Port 5 - 2948
[FD700000 - FD77FFFF]	Intel(R) ICH9 Family PCI Express Root Port 5 - 2948
[FD800000 - FD87FFFF]	Intel(R) ICH9 Family PCI Express Root Port 4 - 2946
[FD900000 - FD97FFFF]	Intel(R) ICH9 Family PCI Express Root Port 4 - 2946
[FDA00000 - FDA7FFFF]	Intel(R) ICH9 Family PCI Express Root Port 3 - 2944
[FDB00000 - FDB7FFFF]	Intel(R) ICH9 Family PCI Express Root Port 3 - 2944
[FDC00000 - FDC7FFFF]	Intel(R) ICH9 Family PCI Express Root Port 2 - 2942
[FDD00000 - FDD7FFFF]	Intel(R) ICH9 Family PCI Express Root Port 2 - 2942
[FDE00000 - FDE7FFFF]	Intel(R) PRO/1000 PL Network Connection #2
[FDE80000 - FDE7FFFF]	Intel(R) Q35 Express Chipset Family
[FDFF8000 - FDFFBFFF]	Microsoft UAA Bus Driver for High Definition Audio
[FDFFD000 - FDFFD0FF]	Intel(R) ICH9 Family SMBus Controller - 2930
[FDFFE000 - FDFFE3FF]	Intel(R) ICH9 Family USB2 Enhanced Host Controller - 293A
[FDFFF000 - FDFFF3FF]	Intel(R) ICH9 Family USB2 Enhanced Host Controller - 293C
[FEB80000 - FEBFFFFF]	Intel(R) Q35 Express Chipset Family
[FEC00000 - FEC0FFFF]	System board



	[FED00000 - FED000FF] System board
	[FED00000 - FED003FF] High precision event timer
	[FED13000 - FED1FFFF] System board
	[FED20000 - FED9FFFF] System board
	[FEE00000 - FEE00FFF] System board
	[FFB00000 - FFB7FFFF] System board
	[FFB80000 - FFBFFFFFF] Intel(R) 82802 Firmware Hub Device
	[FFF00000 - FFFFFFFF] System board

### B3.<System IRQ Resources>

	Interrupt request (IRQ)
	(ISA) 0 High precision event timer
	(ISA) 3 Communications Port (COM2)
	(ISA) 4 Communications Port (COM1)
	(ISA) 5 Communications Port (COM3)
	(ISA) 5 Communications Port (COM4)
	(ISA) 5 Communications Port (COM5)
	(ISA) 5 Communications Port (COM6)
	(ISA) 6 Standard floppy disk controller
	(ISA) 8 High precision event timer
	(ISA) 9 Microsoft ACPI-Compliant System
	(ISA) 13 Numeric data processor
	(PCI) 11 Intel(R) ICH9 Family SMBus Controller - 2930
	(PCI) 16 Intel(R) ICH9 Family PCI Express Root Port 1 - 2940
	(PCI) 16 Intel(R) ICH9 Family PCI Express Root Port 5 - 2948
	(PCI) 16 Intel(R) ICH9 Family USB Universal Host Controller - 2937
	(PCI) 16 Intel(R) PRO/1000 PL Network Connection
	(PCI) 16 Intel(R) Q35 Express Chipset Family
	(PCI) 17 Intel(R) ICH9 Family PCI Express Root Port 2 - 2942
	(PCI) 17 Intel(R) ICH9 Family PCI Express Root Port 6 - 294A
	(PCI) 17 Intel(R) PRO/1000 PL Network Connection #2
	(PCI) 18 Intel(R) ICH9 Family PCI Express Root Port 3 - 2944

	(PCI) 18	Intel(R) ICH9 Family USB Universal Host Controller - 2936
	(PCI) 18	Intel(R) ICH9 Family USB2 Enhanced Host Controller - 293C
	(PCI) 19	Intel(R) ICH9 2 port Serial ATA Storage Controller 2 - 2926
	(PCI) 19	Intel(R) ICH9 4 port Serial ATA Storage Controller 1 - 2920
	(PCI) 19	Intel(R) ICH9 Family PCI Express Root Port 4 - 2946
	(PCI) 19	Intel(R) ICH9 Family USB Universal Host Controller - 2939
	(PCI) 19	Intel(R) ICH9 Family USB Universal Host Controller - 2935
	(PCI) 21	Intel(R) ICH9 Family USB Universal Host Controller - 2938



## Appendix C <Programming GPIO's>

The GPIO can be programmed with the MSDOS debug program using simple IN/OUT commands. The following lines show an example how to do this.

```
GPIO0.....GPIO7  bit0.....bit7
-o 2E 87           ;enter configuration
-o 2E 87
-o 2E 07
-o 2F 09           ;enable GPIO function
-o 2E 30
-o 2F 02           ;enable GPIO configuration
-o 2E F0
-o 2F xx           ;set GPIO as input/output; set '1' for input,'0' for
output
-o 2E F1
-o 2F xx           ;if set GPIO's as output,in this register its value can
be set
```

Optional :

```
-o 2E F2
-o 2F xx           ; Data inversion register ; '1' inverts the current value
of the bits ,'0' leaves them as they are
-o 2E 30
-o 2F 01           ; active GPIO's
```

For further information ,please refer to Winbond W83627DHG datasheet.

## Appendix D <Watch Dog timer Setting >

The watchdog timer makes the system auto-reset while it stops to work for a period. The integrated watchdog timer can be setup as system reset mode by program.

### Timeout Value Range

- 1 to 255
- Second or Minute

### Program Sample

Watchdog timer setup as system reset with 5 second of timeout

---

```

2E, 87
2E, 87
2E, 07
2F, 08      Logical Device 8
2E, 30      Activate
2F, 01
2E, F5      Set as Second*
2F, 00
2E, F6      Set as 5
2F, 05

```

---

\* Minute: bit 3 = 0; Second: bit 3 = 1

You can select Timer setting in the BIOS, after setting the time options, the system will reset according to the period of your selection.

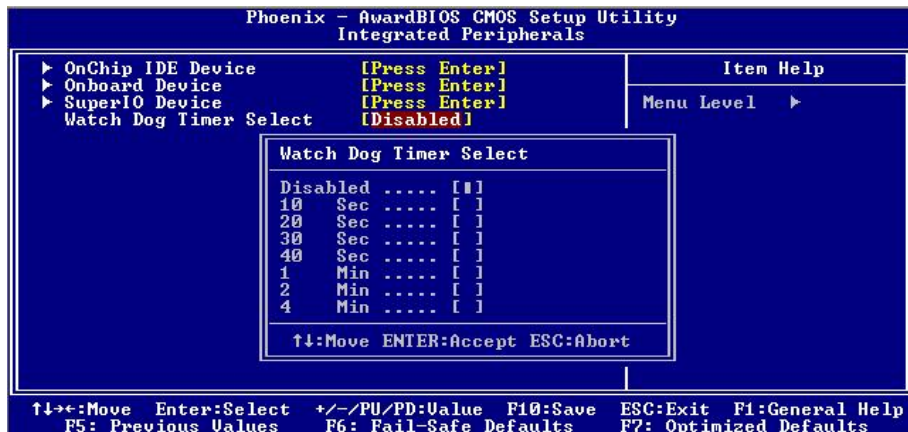

---

Any advice or comments about our products and service, or anything we can help you with please don't hesitate to contact us. We will do our best to support your products, projects and business.



Address: Global American, Inc.  
17 Hampshire Drive  
Hudson, NH 03051

Telephone: Toll Free (U.S. Only) 800-833-8999  
(603)886-3900

FAX: (603)886-4545

Website: <http://www.globalamericaninc.com>  
E-Mail: [salesinfo@globalamericaninc.com](mailto:salesinfo@globalamericaninc.com)

